

Dessiner de l'UML avec PlantUML

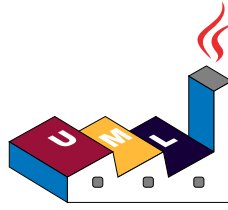

Guide de référence du langage PlantUML

(Version 1.2023.11)

PlantUML est un composant qui permet de dessiner rapidement des:

- diagrammes de séquence
- diagrammes de cas d'utilisation
- diagrammes de classes
- diagrammes d'objet
- diagrammes d'activité
- diagrammes de composant
- diagrammes de déploiement
- diagrammes d'état
- diagrammes de temps

Certains autres diagrammes (hors UML) sont aussi possibles:

- données au format JSON
- données au format YAML
- diagrammes de réseaux (nwdiag)
- maquettes d'interface graphique (salt)
- diagrammes Archimate
- diagrammes de langage de description et de spécification (SDL)
- diagrammes ditaa
- diagrammes de Gantt
- diagrammes d'idées (mindmap)
- organigramme (Work Breakdown Structure)
- notation mathématique avec AsciiMath ou JLaTeXMath
- diagrammes entité relation (ER/IE)

Les diagrammes sont définis à l'aide d'un langage simple et intuitif.

1 Diagramme de séquence

Créer des diagrammes de séquence avec PlantUML est remarquablement simple. Cette facilité d'utilisation est largement attribuée à la nature conviviale de sa syntaxe, conçue pour être à la fois intuitive et facile à mémoriser.

- **Syntaxe intuitive :**

Tout d'abord, les utilisateurs apprécient la syntaxe simple et intuitive de PlantUML. Cette conception bien pensée signifie que même ceux qui sont novices dans la création de diagrammes trouvent qu'il est facile de saisir les bases rapidement et sans problème.

- **Corrélation texte-graphique :**

Une autre caractéristique distinctive est l'étroite ressemblance entre la représentation textuelle et la sortie graphique. Cette corrélation harmonieuse garantit que les ébauches textuelles se traduisent très précisément en diagrammes graphiques, offrant une expérience de conception cohérente et prévisible, sans surprise désagréable dans le résultat final.

- **Processus d'élaboration efficace :**

La forte corrélation entre le texte et le résultat graphique simplifie non seulement le processus de création, mais l'accélère également de manière significative. Les utilisateurs bénéficient d'un processus plus rationnel, avec moins de révisions et d'ajustements fastidieux.

- **Visualisation pendant la rédaction :**

La possibilité d'envisager le résultat graphique final tout en rédigeant le texte est une fonction que beaucoup trouvent inestimable. Elle favorise naturellement une transition en douceur entre le projet initial et la présentation finale, ce qui améliore la productivité et réduit la probabilité d'erreurs.

- **Facilité d'édition et de révision :**

Il est important de noter que l'édition des diagrammes existants est un processus sans problème. Comme les diagrammes sont générés à partir de texte, les utilisateurs constatent qu'il est beaucoup plus facile et plus précis de faire des ajustements que de modifier une image à l'aide d'outils graphiques. Il s'agit simplement de modifier le texte, un processus beaucoup plus simple et moins sujet aux erreurs que de faire des changements à travers une interface graphique avec une souris.

PlantUML facilite une approche directe et conviviale de la création et de l'édition de diagrammes de séquence, répondant aux besoins des novices comme des concepteurs chevronnés. Il exploite habilement la simplicité des entrées textuelles pour créer des diagrammes visuellement descriptifs et précis, s'imposant ainsi comme un outil indispensable dans la boîte à outils de création de diagrammes.

Vous pouvez en savoir plus sur certaines des commandes courantes de PlantUML pour améliorer votre expérience de création de diagrammes.

1.1 Exemples de base

La séquence `->` est utilisée pour dessiner un message entre deux participants. Les participants ne sont pas forcément déclarés explicitement.

Pour avoir une flèche en pointillé, vous utilisez `-->`

Il est également possible d'utiliser `<-` et `<--`. Cela ne change pas le dessin, mais peut améliorer la lisibilité. Notez que cela n'est vrai que pour les diagrammes de séquence, les règles sont différentes pour les autres diagrammes

```
@startuml
Alice -> Bob: Authentication Request
Bob --> Alice: Authentication Response

Alice -> Bob: Another authentication Request
Alice <-- Bob: Another authentication Response
@enduml
```



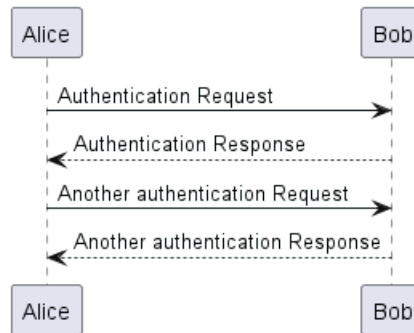

1.2 Déclaration d'un participant

Si le mot-clé `participant` est utilisé pour déclarer un participant, il est possible d'exercer un contrôle accru sur ce participant.

L'ordre de déclaration sera l'**ordre d'affichage**(par défaut).

L'utilisation de ces autres mots-clés pour déclarer des participants **modifiera la forme de** la représentation du participant :

- `actor`
- `boundary`
- `control`
- `entity`
- `database`
- `collections`
- `queue`

```

@startuml
participant Participant as Foo
actor Actor as Foo1
boundary Boundary as Foo2
control Control as Foo3
entity Entity as Foo4
database Database as Foo5
collections Collections as Foo6
queue Queue as Foo7
Foo -> Foo1 : To actor
Foo -> Foo2 : To boundary
Foo -> Foo3 : To control
Foo -> Foo4 : To entity
Foo -> Foo5 : To database
Foo -> Foo6 : To collections
Foo -> Foo7: To queue
@enduml
  
```

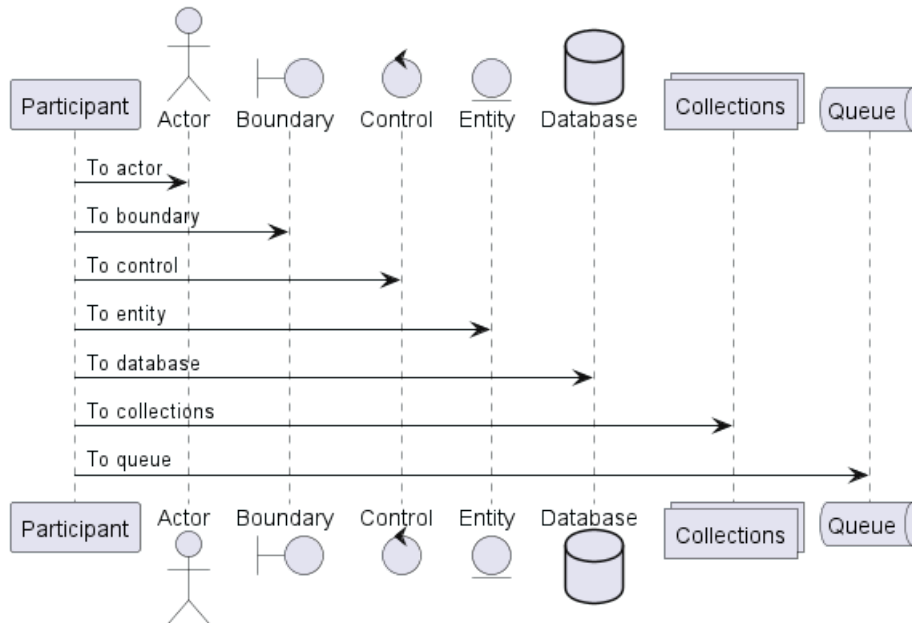

Renommez un participant en utilisant le mot-clé `as`.

Vous pouvez également modifier la couleur de fond de l'acteur ou du participant .

```
@startuml
actor Bob #red
' The only difference between actor
'and participant is the drawing
participant Alice
participant "I have a really\nlong name" as L #99FF99
/' You can also declare:
    participant L as "I have a really\nlong name" #99FF99
  '/
```

```
Alice->Bob: Authentication Request
Bob->Alice: Authentication Response
Bob->L: Log transaction
@enduml
```

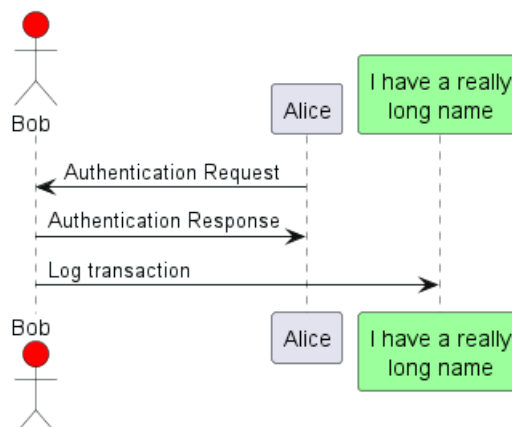

Vous pouvez utiliser le mot-clé `order` pour personnaliser l'ordre d'affichage des participants.

```
@startuml
participant Last order 30
participant Middle order 20
participant First order 10
```



```
@enduml
```

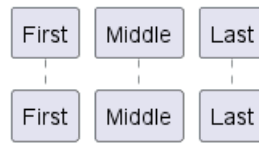

1.3 Declaring participant on multiline

You can declare participant on multi-line.

```
@startuml
participant Participant [
  =Title
  ----
  ""SubTitle""
]
```

```
participant Bob
```

```
Participant -> Bob
@enduml
```

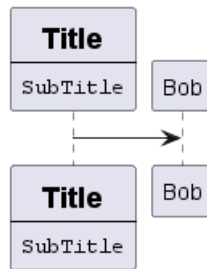

[Ref. QA-15232]

1.4 Caractères non alphanumérique dans les participants

Si vous voulez mettre des caractères non alphanumériques, il est possible d'utiliser des guillemets. Et on peut utiliser le mot clé `as` pour définir un alias pour ces participants.

```
@startuml
Alice -> "Bob()" : Hello
"Bob()" -> "This is very\nlong" as Long
' You can also declare:
' "Bob()" -> Long as "This is very\nlong"
Long --> "Bob()" : ok
@enduml
```

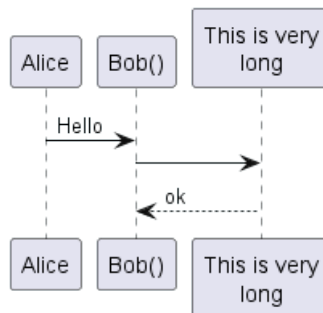

1.5 Message à soi-même

Un participant peut s'envoyer un message à lui-même.

Il est également possible d'avoir plusieurs lignes en utilisant

```
@startuml
Alice -> Alice: This is a signal to self.\nIt also demonstrates\nmultiline \ntext
@enduml
```

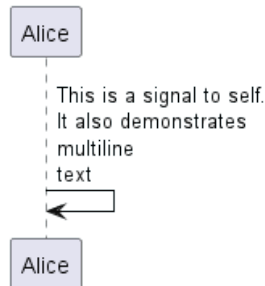

```
@startuml
Alice <- Alice: This is a signal to self.\nIt also demonstrates\nmultiline \ntext
@enduml
```

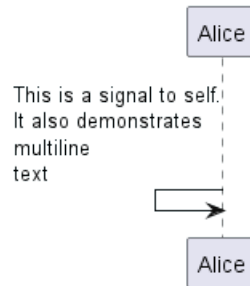

[Réf. QA-1361]

1.6 Alignement du texte

L'alignement du texte sur les flèches peut être défini sur `left`, `right` ou `center` en utilisant `skinparam sequenceMessageAlign`.

Vous pouvez également utiliser `direction` ou `reverseDirection` pour aligner le texte en fonction de la direction de la flèche. De plus amples détails et des exemples sont disponibles sur la page `skinparam`.

```
@startuml
skinparam sequenceMessageAlign right
Bob -> Alice : Request
Alice -> Bob : Response
@enduml
```

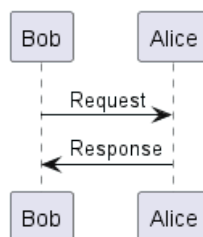

1.6.1 Texte du message de réponse sous la flèche

Vous pouvez placer le texte du message de réponse sous la flèche, avec la commande `skinparam responseMessageBelowArrow true`



```

@startuml
skinparam responseMessageBelowArrow true
Bob -> Alice : hello
Alice -> Bob : ok
@enduml

```

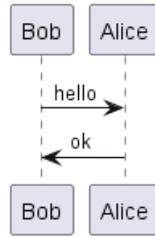

1.7 Autre style de flèches

Vous pouvez changer les flèches de plusieurs façons :

- Pour indiquer un message perdu, terminer la flèche avec **x**
- Utiliser **** ou **/** à la place de **<** ou **>** pour avoir seulement la partie supérieure ou inférieure de la flèche.
- Doubler un des caractères (par exemple, **>>** ou **//**) pour avoir une flèche plus fine.
- Utiliser **--** à la place de **-** pour avoir des pointillés.
- Utiliser **o** après la flèche
- Utiliser une flèche bi-directionnelle **<->**

```

@startuml
Bob ->x Alice
Bob -> Alice
Bob ->> Alice
Bob -\ Alice
Bob \\- Alice
Bob //-- Alice

Bob ->o Alice
Bob o\\-- Alice

Bob <-> Alice
Bob <->o Alice
@enduml

```

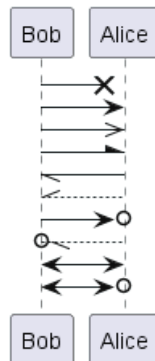

1.8 Changer la couleur des flèches

Changer la couleur d'une flèche ainsi:



```

@startuml
Bob -[#red]> Alice : bonjour
Alice -[#0000FF]->Bob : ok
@enduml

```

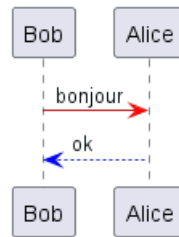

1.9 Numérotation séquentielle des messages

Le mot clé `autonumber` est utilisé pour ajouter automatiquement un numéro incrémentiel aux messages

```

@startuml
autonumber
Bob -> Alice : Authentication Request
Bob <- Alice : Authentication Response
@enduml

```

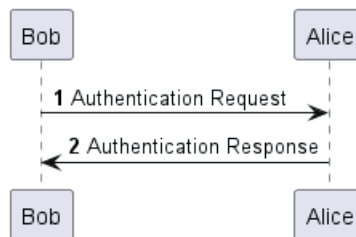

Vous pouvez spécifier un numéro de début avec `autonumber <start>` et également un incrément avec `autonumber <start> <increment>`.

```

@startuml
autonumber
Bob -> Alice : Authentication Request
Bob <- Alice : Authentication Response

autonumber 15
Bob -> Alice : Another authentication Request
Bob <- Alice : Another authentication Response

autonumber 40 10
Bob -> Alice : Yet another authentication Request
Bob <- Alice : Yet another authentication Response

@enduml

```

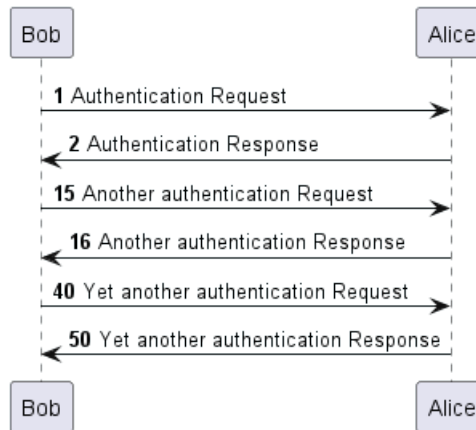
Vous pouvez spécifier un format pour votre nombre en utilisant entre guillemets.

Le formatage est fait avec la classe Java DecimalFormat (0 signifie chiffre, # signifie chiffre et zéro si absent).

Vous pouvez utiliser une balise html dans le format

```

@startuml
autonumber "<b>[000]"
Bob -> Alice : Authentication Request
Bob <- Alice : Authentication Response

autonumber 15 "<b>(<u>##</u>)"
Bob -> Alice : Another authentication Request
Bob <- Alice : Another authentication Response

autonumber 40 10 "<font color=red><b>Message 0 "
Bob -> Alice : Yet another authentication Request
Bob <- Alice : Yet another authentication Response

@enduml
  
```

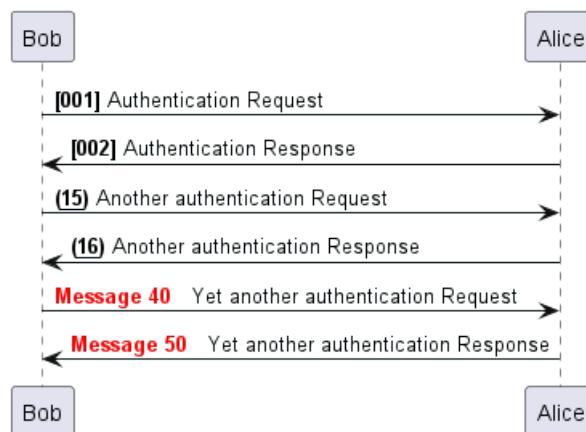

Vous pouvez également utiliser `autonumber stop` et `autonumber resume <increment> <format>` pour respectivement interrompre et reprendre la numérotation automatique de

```

@startuml
autonumber 10 10 "<b>[000]"
Bob -> Alice : Authentication Request
Bob <- Alice : Authentication Response

autonumber stop
Bob -> Alice : dummy
  
```



```

autonumber resume "<font color=red><b>Message 0 "
Bob -> Alice : Yet another authentication Request
Bob <- Alice : Yet another authentication Response

autonumber stop
Bob -> Alice : dummy

autonumber resume 1 "<font color=blue><b>Message 0 "
Bob -> Alice : Yet another authentication Request
Bob <- Alice : Yet another authentication Response
@enduml

```

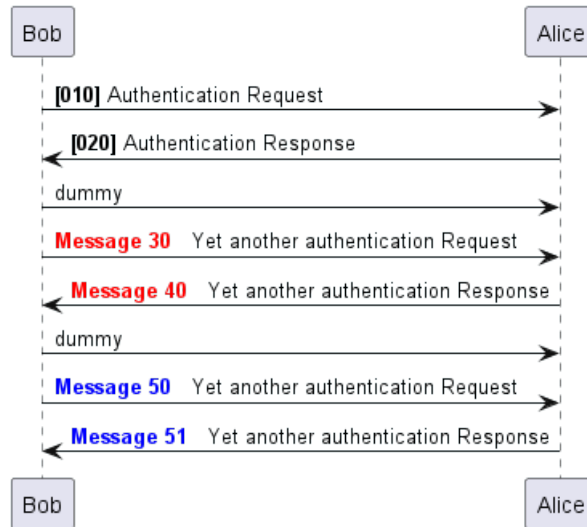

Votre numéro de départ peut également être une séquence de 2 ou 3 chiffres utilisant un délimiteur de champ tel que ., ;, ,, : ou un mélange de ceux-ci. Par exemple : 1.1.1 ou 1.1:1.

Le dernier chiffre s'incrémente automatiquement.

Pour incrémenter le premier chiffre, utilisez : `autonumber inc A`. Pour incrémenter le deuxième chiffre, utilisez : `autonumber inc B`

```

@startuml
autonumber 1.1.1
Alice -> Bob: Authentication request
Bob --> Alice: Response

autonumber inc A
'Now we have 2.1.1
Alice -> Bob: Another authentication request
Bob --> Alice: Response

autonumber inc B
'Now we have 2.2.1
Alice -> Bob: Another authentication request
Bob --> Alice: Response

autonumber inc A
'Now we have 3.1.1
Alice -> Bob: Another authentication request
autonumber inc B
'Now we have 3.2.1
Bob --> Alice: Response
@enduml

```



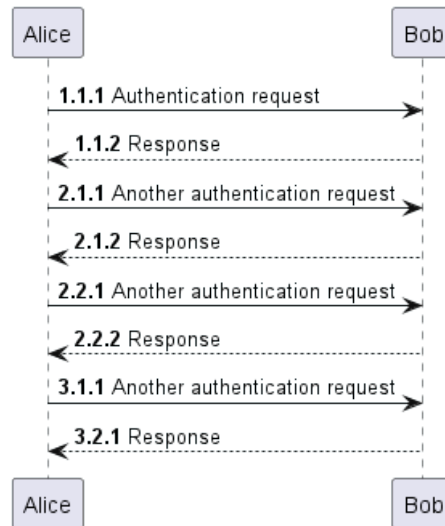

Vous pouvez également utiliser la valeur de `autonumber` avec la variable `%autonumber%`

```

@startuml
autonumber 10
Alice -> Bob
note right
  the <U+0025>autonumber<U+0025> works everywhere.
  Here, its value is ** %autonumber% **
end note
Bob --> Alice: //This is the response %autonumber%//
@enduml
  
```

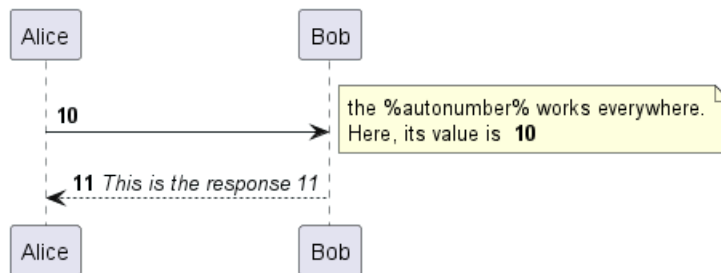

[Réf. QA-7119]

1.10 Titre, en-tête et pied de page de la page

Le mot clé `title` est utilisé pour ajouter un titre à la page.

Les pages peuvent afficher des en-têtes et des pieds de page en utilisant `header` et `footer`.

```

@startuml

header Page Header
footer Page %page% of %lastpage%

title Example Title

Alice -> Bob : message 1
Alice -> Bob : message 2

@enduml
  
```



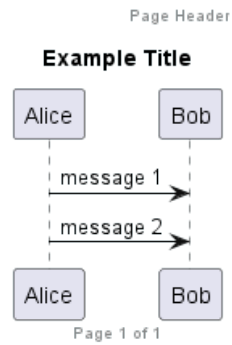

1.11 Découper un diagramme

Le mot clé `newpage` est utilisé pour découper un digramme en plusieurs images.

Vous pouvez mettre un titre pour la nouvelle page juste après le mot clé `newpage`.

Ceci est très pratique pour mettre de très longs digrammes sur plusieurs pages.

```
@startuml
```

```
Alice -> Bob : message 1
```

```
Alice -> Bob : message 2
```

```
newpage
```

```
Alice -> Bob : message 3
```

```
Alice -> Bob : message 4
```

```
newpage A title for the\nlast page
```

```
Alice -> Bob : message 5
```

```
Alice -> Bob : message 6
```

```
@enduml
```

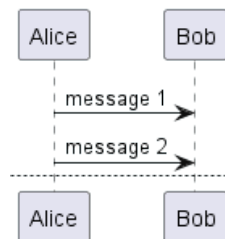

1.12 Regrouper les messages (cadres UML)

Il est possible de regrouper les messages dans un cadre UML à l'aide d'un des mot clés suivants:

- `alt/else`
- `opt`
- `loop`
- `par`
- `break`
- `critical`
- `group`, suivi par le texte à afficher

Il est aussi possible de mettre un texte à afficher dans l'entête. Le mot-clé `end` est utilisé pour fermer le groupe. Il est aussi possible d'imbriquer les groupes.

Terminer le cadre avec le mot-clé `end`.

Il est possible d'imbriquer les cadres.

```

@startuml
Alice -> Bob: Authentication Request

alt successful case

    Bob -> Alice: Authentication Accepted

else some kind of failure

    Bob -> Alice: Authentication Failure
    group My own label
    Alice -> Log : Log attack start
        loop 1000 times
            Alice -> Bob: DNS Attack
        end
    Alice -> Log : Log attack end
    end

else Another type of failure

    Bob -> Alice: Please repeat

end
@enduml

```

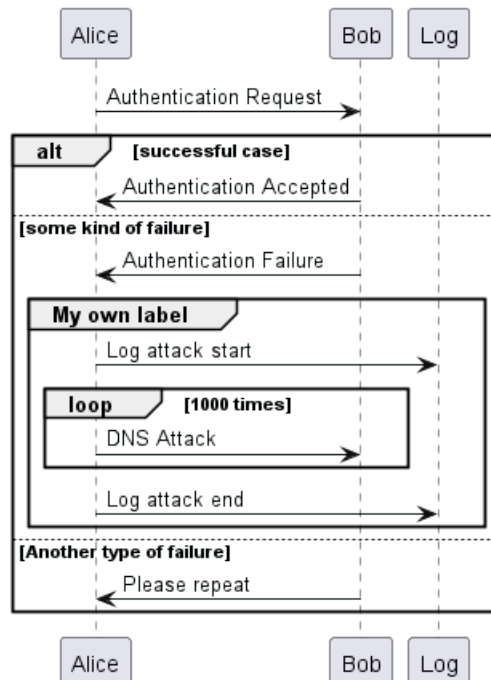

1.13 Étiquette secondaire de groupe

Pour les `group`, il est possible d'ajouter, entre [et], un texte ou une étiquette secondaire qui sera affiché dans l'en-tête

```

@startuml

```



```

Alice -> Bob: Authentication Request
Bob -> Alice: Authentication Failure
group My own label [My own label 2]
  Alice -> Log : Log attack start
  loop 1000 times
    Alice -> Bob: DNS Attack
  end
  Alice -> Log : Log attack end
end
@enduml

```

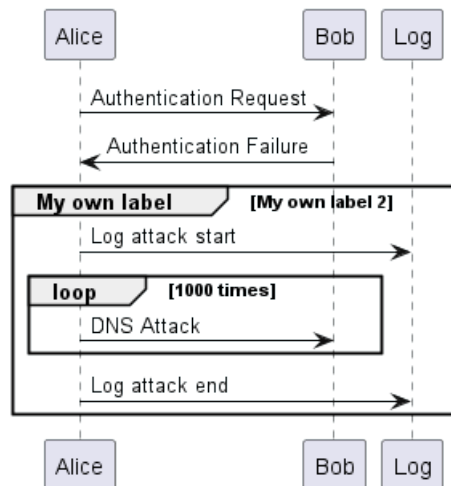

[Réf. QA-2503]

1.14 Note sur les messages

Pour attacher une note à un message, utiliser les mots-clés `note left` (pour une note à gauche) ou `note right` (pour une note à droite) *juste après le message*.

Il est possible d'avoir une note sur plusieurs lignes avec le mot clé `end note`.

```

@startuml
Alice->Bob : hello
note left: this is a first note

Bob->Alice : ok
note right: this is another note

Bob->Bob : I am thinking
note left
a note
can also be defined
on several lines
end note
@enduml

```



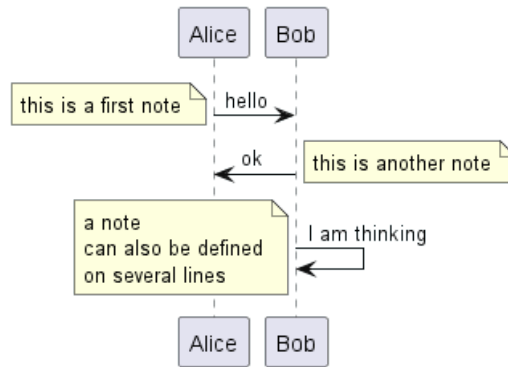

1.15 Encore plus de notes

Il est aussi possible de mettre des notes placées par rapport aux participants.

Il est aussi possible de faire ressortir une note en changeant sa couleur de fond.

On peut aussi avoir des notes sur plusieurs lignes à l'aide du mot clé `end note`.

```

@startuml
participant Alice
participant Bob
note left of Alice #aqua
This is displayed
left of Alice.
end note
  
```

```

note right of Alice: This is displayed right of Alice.
  
```

```

note over Alice: This is displayed over Alice.
  
```

```

note over Alice, Bob #FFAAAA: This is displayed\n over Bob and Alice.
  
```

```

note over Bob, Alice
This is yet another
example of
a long note.
end note
@enduml
  
```

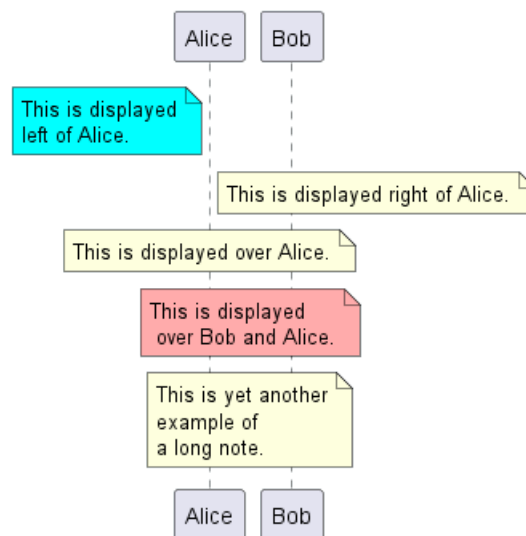

1.16 Changer l'aspect des notes

Vous pouvez préciser la forme géométrique des notes :

- `rnote` : pour rectangulaire,
- `hnote` : pour hexagonale.

```
@startuml
caller -> server : conReq
hnote over caller : idle
caller <- server : conConf
rnote over server
  "r" as rectangle
  "h" as hexagon
endrnote
rnote over server
  this is
  on several
  lines
endrnote
hnote over caller
  this is
  on several
  lines
endhnote
@enduml
```

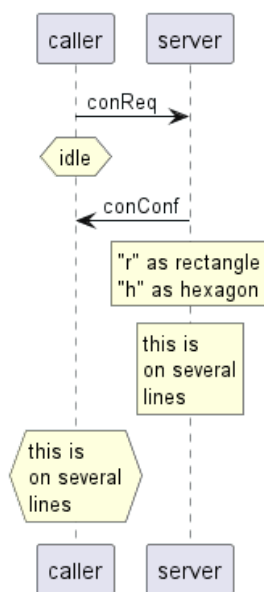

[Ref. QA-1765]

1.17 Note sur tous les participants [à travers]

Vous pouvez directement faire une note sur tous les participants, avec la syntaxe :

- `note across: note_description`

```
@startuml
Alice->>Bob:m1
Bob->>Charlie:m2
note over Alice, Charlie: Old method for note over all part. with:\n ""note over //FirstPart, LastPart""
note across: New method with:\n""note across""
Bob->>Alice
hnote across:Note across all part.
```



```
@enduml
```

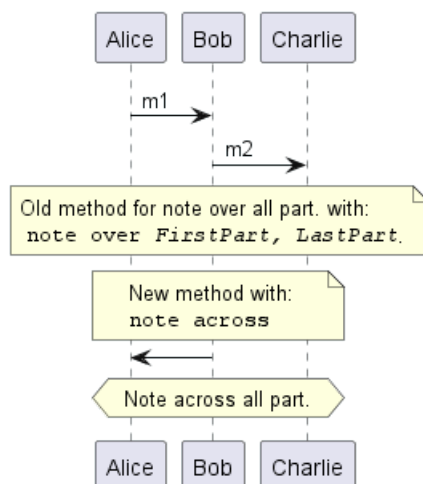

[Réf. QA-9738]

1.18 Plusieurs notes alignées au même niveau [/]

Vous pouvez faire plusieurs notes alignées au même niveau, avec la syntaxe /:

- sans / (par défaut, les notes ne sont pas alignées)

```
@startuml
```

```
note over Alice : initial state of Alice
```

```
note over Bob : initial state of Bob
```

```
Bob -> Alice : hello
```

```
@enduml
```

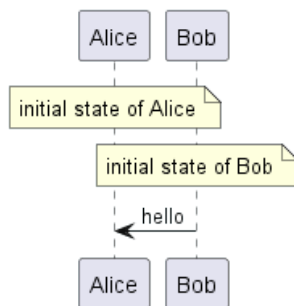

- avec / (les notes sont alignées)

```
@startuml
```

```
note over Alice : initial state of Alice
```

```
/ note over Bob : initial state of Bob
```

```
Bob -> Alice : hello
```

```
@enduml
```

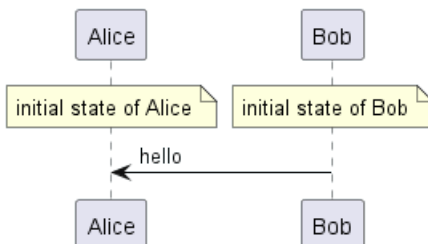

[Réf. QA-354]



1.19 Créole (langage de balisage léger) et HTML

Il est également possible d'utiliser le formatage créole (langage de balisage léger):

```
@startuml
participant Alice
participant "The Famous Bob" as Bob

Alice -> Bob : hello --there--
... Some ~~long delay~~ ...
Bob -> Alice : ok
note left
  This is bold
  This is italics
  This is "monospaced"
  This is --stroked--
  This is underlined
  This is ~waved~
end note

Alice -> Bob : A //well formatted// message
note right of Alice
  This is <back:cadetblue><size:18>displayed</size></back>
  __left of__ Alice.
end note
note left of Bob
  <u:red>This</u> is <color #118888>displayed</color>
  **<color purple>left of</color> <s:red>Alice</strike> Bob**.
end note
note over Alice, Bob
  <w:#FF33FF>This is hosted</w> by <img sourceforge.jpg>
end note
@enduml
```

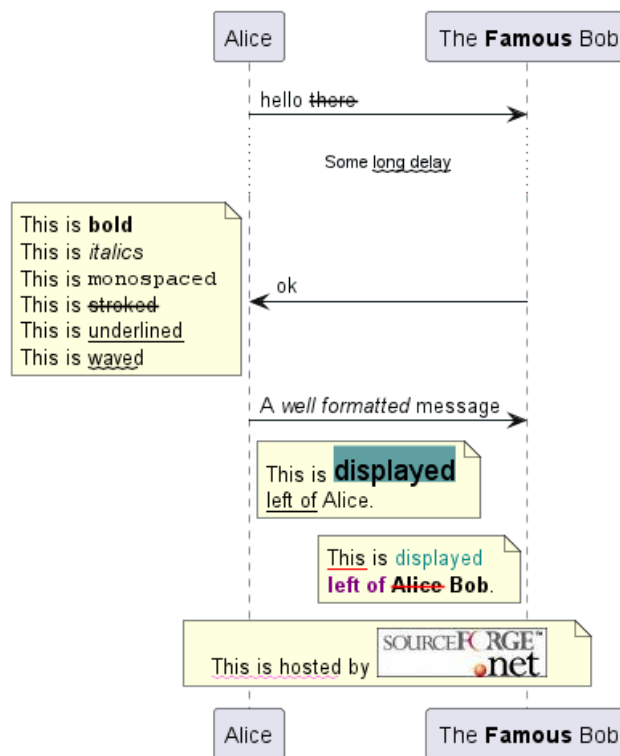

1.20 Diviseur ou séparateur

Si vous le souhaitez, vous pouvez diviser un diagramme en utilisant == comme séparateur pour diviser votre diagramme en étapes logiques

```
@startuml

== Initialization ==

Alice -> Bob: Authentication Request
Bob --> Alice: Authentication Response

== Repetition ==

Alice -> Bob: Another authentication Request
Alice <-- Bob: another authentication Response

@enduml
```

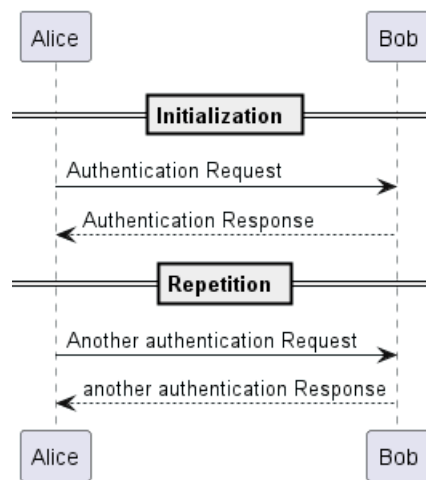

1.21 Référence

Vous pouvez ajouter des références dans un diagramme, en utilisant le mot-clé `ref over`.

```
@startuml
participant Alice
actor Bob

ref over Alice, Bob : init

Alice -> Bob : hello

ref over Bob
    This can be on
    several lines
end ref
@enduml
```

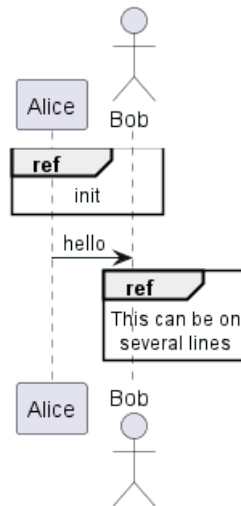

1.22 Retard

Utiliser ... pour indiquer le passage de temps arbitraire dans le diagramme. Un message peut être associé à un retard.

```
@startuml
```

```
Alice -> Bob: Authentication Request
```

```
...
```

```
Bob --> Alice: Authentication Response
```

```
...5 minutes later...
```

```
Bob --> Alice: Bye !
```

```
@enduml
```

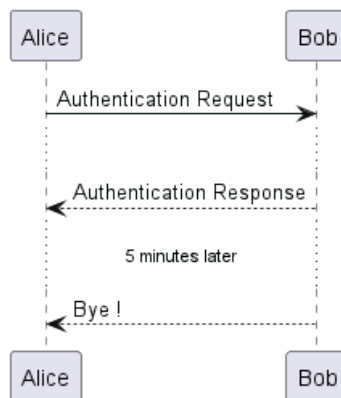

1.23 Habillage du texte

Pour interrompre de longs messages, vous pouvez ajouter manuellement dans votre texte.

Une autre option consiste à utiliser le paramètre `maxMessageSize`

```
@startuml
```

```
skinparam maxMessageSize 50
```

```
participant a
```

```
participant b
```

```
a -> b :this\nis\nmanually\ndone
```

```
a -> b :this is a very long message on several words
```

```
@enduml
```



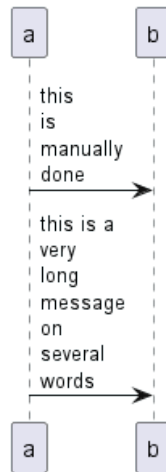

1.24 Séparation verticale

Utiliser `|||` pour créer un espace vertical dans le diagramme.

Il est également possible de spécifier un nombre de pixels pour la séparation verticale.

```
@startuml
Alice -> Bob: message 1
Bob --> Alice: ok
|||
Alice -> Bob: message 2
Bob --> Alice: ok
||45||
Alice -> Bob: message 3
Bob --> Alice: ok
@enduml
```

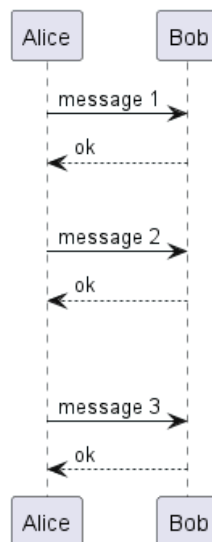

1.25 Lignes de vie

Vous pouvez utiliser `activate` et `deactivate` pour marquer l'activation des participants.

Une fois qu'un participant est activé, sa ligne de vie apparaît.

Les ordres `activate` et `deactivate` s'applique sur le message situé juste avant.



Le mot clé `destroy` sert à montrer la fin de vie d'un participant.

```

@startuml
participant User

User -> A: DoWork
activate A

A -> B: << createRequest >>
activate B

B -> C: DoWork
activate C
C --> B: WorkDone
destroy C

B --> A: RequestCreated
deactivate B

A -> User: Done
deactivate A

@enduml

```

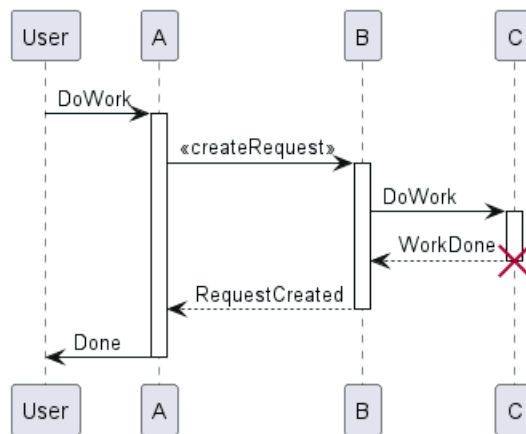

Les lignes de vie peuvent être imbriquées, et il est possible de les colorer.

```

@startuml
participant User

User -> A: DoWork
activate A #FFBBBB

A -> A: Internal call
activate A #DarkSalmon

A -> B: << createRequest >>
activate B

B --> A: RequestCreated
deactivate B
deactivate A

A -> User: Done
deactivate A

@enduml

```



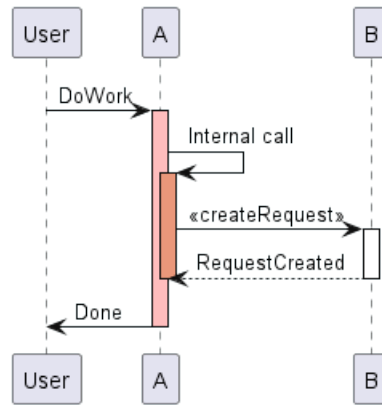

1.26 Retour

La commande `return` génère un message de retour avec un libellé facultatif.

Le point de retour est celui qui a provoqué l'activation la plus récente de la ligne de vie.

La syntaxe est `return label` où `label`, si elle est fournie, est toute chaîne acceptable pour les messages conventionnels.

```

@startuml
Bob -> Alice : hello
activate Alice
Alice -> Alice : some action
return bye
@enduml
  
```

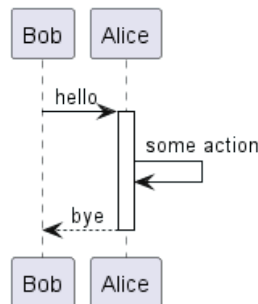

1.27 Création d'un participant

Vous pouvez utiliser le mot clé `create` juste avant la première réception d'un message pour souligner le fait que ce message *crée* effectivement ce nouvel objet.

```

@startuml
Bob -> Alice : hello

create Other
Alice -> Other : new

create control String
Alice -> String
note right : You can also put notes!

Alice --> Bob : ok
@enduml
  
```



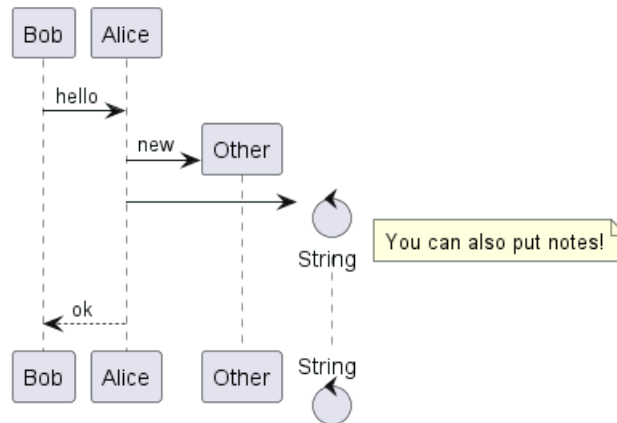

1.28 Syntaxe raccourcie pour l'activation, la désactivation, la création

Immédiatement après avoir spécifié le participant cible, la syntaxe suivante peut être utilisée :

- ++ Activer la cible (une couleur peut éventuellement suivre)
- -- Désactiver la source
- ** Créer une instance de la cible
- !! Détruire une instance de la cible

```

@startuml
alice -> bob ++ : hello
bob -> bob ++ : self call
bob -> bib ++ #005500 : hello
bob -> george ** : create
return done
return rc
bob -> george !! : delete
return success
@enduml
    
```

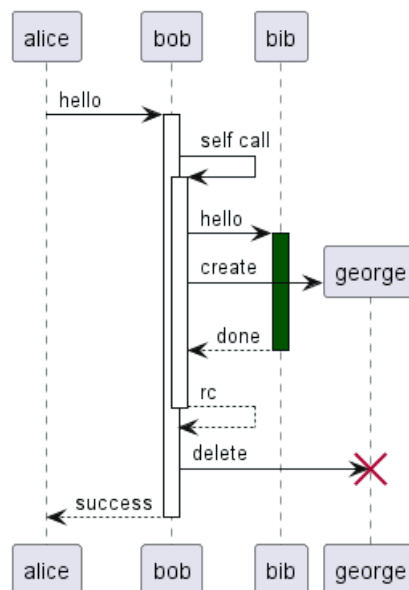

Vous pouvez alors mélanger activation et désactivation, sur la même ligne

```

@startuml
alice -> bob ++ : hello1
    
```



```

bob      -> charlie ---+ : hello2
charlie --> alice   --   : ok
@enduml

```

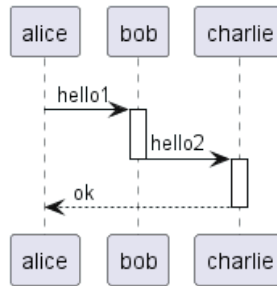

```

@startuml
@startuml
alice -> bob   ---+ #gold: hello
bob   -> alice ---+ #gold: you too
alice -> bob   --: step1
alice -> bob   : step2
@enduml
@enduml

```

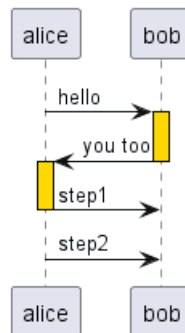

[Réf. QA-4834, QA-9573 et QA-13234]

1.29 Messages entrant et sortant

Vous pouvez utiliser des flèches qui viennent de la droite ou de la gauche pour dessiner un sous-diagramme.

Il faut utiliser des crochets pour indiquer la gauche ”[” ou la droite ”]” du diagramme.

```

@startuml
[-> A: DoWork

activate A

A -> A: Internal call
activate A

A ->] : << createRequest >>

A<--] : RequestCreated
deactivate A
[<- A: Done
deactivate A
@enduml

```



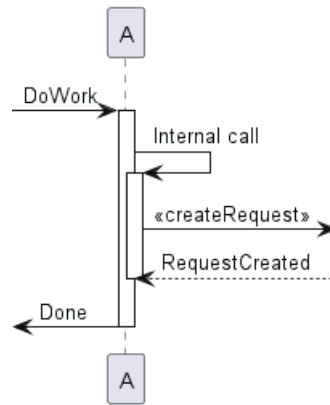

Vous pouvez aussi utiliser la syntaxe suivante:

```

@startuml
[-> Bob
[o-> Bob
[o->o Bob
[x-> Bob

[<- Bob
[x<- Bob

Bob ->]
Bob ->o]
Bob o->o]
Bob ->x]

Bob <-]
Bob x<-]
@enduml
  
```



1.30 Flèches courtes pour les messages entrants et sortants

Vous pouvez avoir des flèches **courtes** en utilisant ?

```

@startuml
?-> Alice : "?->"\n**short** to actor1
[-> Alice : "[->"\n**from start** to actor1
[-> Bob : "[->"\n**from start** to actor2
?-> Bob : "?->"\n**short** to actor2
Alice ->] : "->]"\nfrom actor1 **to end**
Alice ->? : "->?"\n**short** from actor1
Alice -> Bob : "->" \nfrom actor1 to actor2
  
```



@enduml

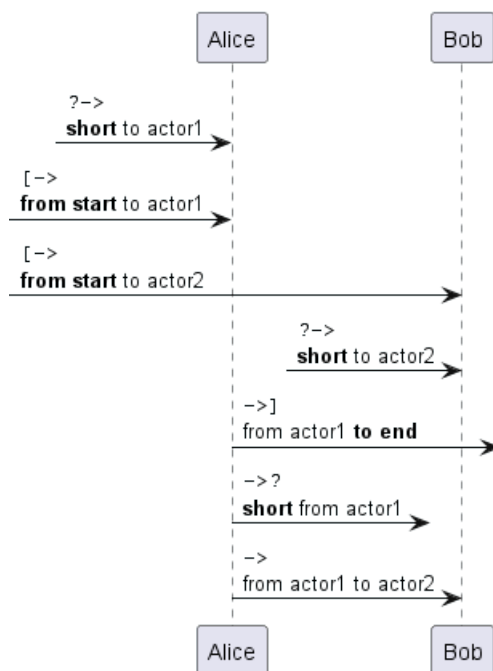

[Réf. QA-310]

1.31 Anchors and Duration

En utilisant `teoz` il est possible d'ajouter des balises au diagramme et d'utiliser ces balises pour préciser la durée.

```
@startuml
!pragma teoz true
```

```
{start} Alice -> Bob : commencer a faire quelque chose pour une certaine duree
Bob -> Max : quelque chose
Max -> Bob : quelque chose d'autre
{end} Bob -> Alice : terminer
```

```
{start} <-> {end} : la duree en question
```

@enduml

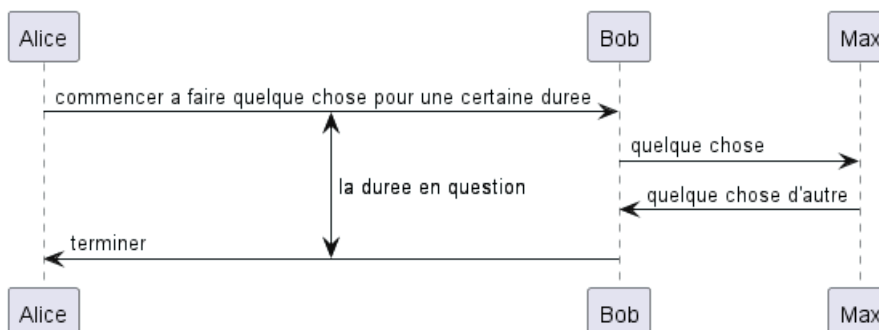

Vous pouvez utiliser l'option de ligne de commande `-P` pour spécifier le pragma:

```
java -jar plantuml.jar -Pteoz=true
```

[Réf. issue-582]

1.32 Stéréotypes et décoration

Il est possible de rajouter un stéréotype aux participants en utilisant "<<" et ">>".

Dans le stéréotype, vous pouvez ajouter un caractère entouré d'un cercle coloré en utilisant la syntaxe (X,couleur).

```
@startuml
participant "Famous Bob" as Bob << Generated >>
participant Alice << (C,#ADD1B2) Testable >>

Bob->>Alice: First message

@enduml
```

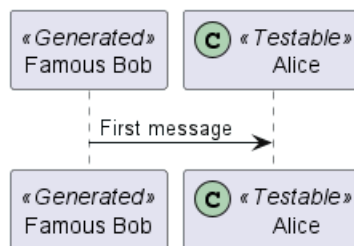

Par défaut, le caractère *guillemet* est utilisé pour afficher les stéréotypes. Vous pouvez changer ce comportement en utilisant la propriété `skinparam guillemet`:

```
@startuml
skinparam guillemet false
participant "Famous Bob" as Bob << Generated >>
participant Alice << (C,#ADD1B2) Testable >>

Bob->>Alice: First message

@enduml
```

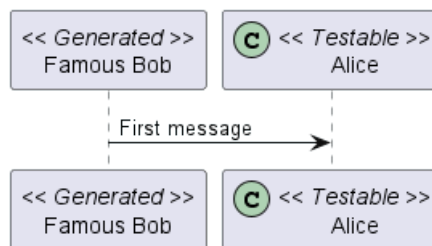

```
@startuml
participant Bob << (C,#ADD1B2) >>
participant Alice << (C,#ADD1B2) >>

Bob->>Alice: First message

@enduml
```

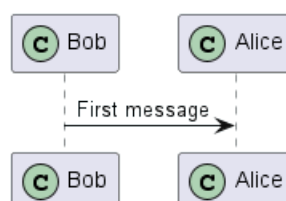

1.33 Plus d'information sur les titres

Vous pouvez utiliser le formatage creole dans le titre.

```
@startuml
title __Simple__ communication example
Alice -> Bob: Authentication Request
Bob -> Alice: Authentication Response
@enduml
```

Simple communication example

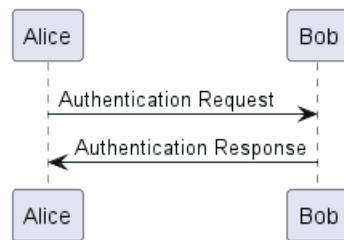

Vous pouvez mettre des retours à la ligne en utilisant `\n` dans la description.

```
@startuml
title __Simple__ communication example\nnon several lines
Alice -> Bob: Authentication Request
Bob -> Alice: Authentication Response
@enduml
```

Simple communication example on several lines

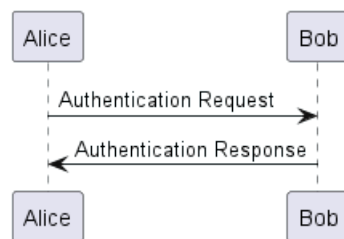

Vous pouvez aussi mettre un titre sur plusieurs lignes à l'aide des mots-clé `title` et `end title`.

```
@startuml
title
  <u>Simple</u> communication example
  on <i>several</i> lines and using <font color=red>html</font>
  This is hosted by <img:sourceforge.jpg>
end title
Alice -> Bob: Authentication Request
Bob -> Alice: Authentication Response
@enduml
```



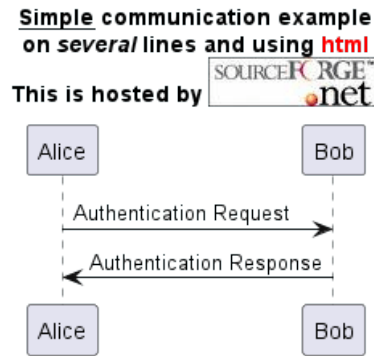

1.34 Cadre pour les participants

Il est possible de dessiner un cadre autour de certains participants, en utilisant les commandes `box` et `end box`.

Vous pouvez ajouter un titre ou bien une couleur de fond après le mot-clé `box`.

```

@startuml

box "Internal Service" #LightBlue
  participant Bob
  participant Alice
end box
participant Other

Bob -> Alice : hello
Alice -> Other : hello

@enduml
  
```

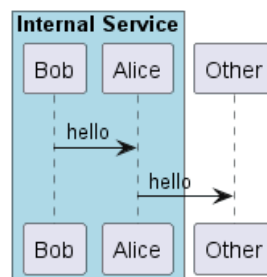

1.35 Supprimer les participants en pied de page

Vous pouvez utiliser le mot-clé `hide footbox` pour supprimer la partie basse du diagramme.

```

@startuml

hide footbox
title Footer removed

Alice -> Bob: Authentication Request
Bob --> Alice: Authentication Response

@enduml
  
```

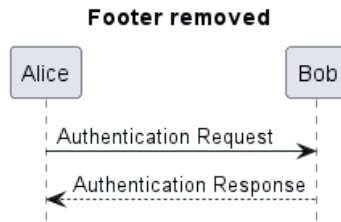

1.36 Personnalisation

Utilisez la commande `skinparam` pour changer la couleur et la mise en forme du texte du schéma.

Vous pouvez utiliser cette commande :

- Dans la définition du diagramme, comme pour les autres commandes,
- Dans un fichier inclus,
- Dans un fichier de configuration, renseigné dans la ligne de commande ou la tâche ANT.

Vous pouvez aussi modifier d'autres paramètres pour le rendu, comme le montrent les exemples suivants:

```

@startuml
skinparam sequenceArrowThickness 2
skinparam roundcorner 20
skinparam maxmessagesize 60
skinparam sequenceParticipant underline
  
```

```

actor User
participant "First Class" as A
participant "Second Class" as B
participant "Last Class" as C
  
```

```

User -> A: DoWork
activate A
  
```

```

A -> B: Create Request
activate B
  
```

```

B -> C: DoWork
activate C
C --> B: WorkDone
destroy C
  
```

```

B --> A: Request Created
deactivate B
  
```

```

A --> User: Done
deactivate A
  
```

```

@enduml
  
```



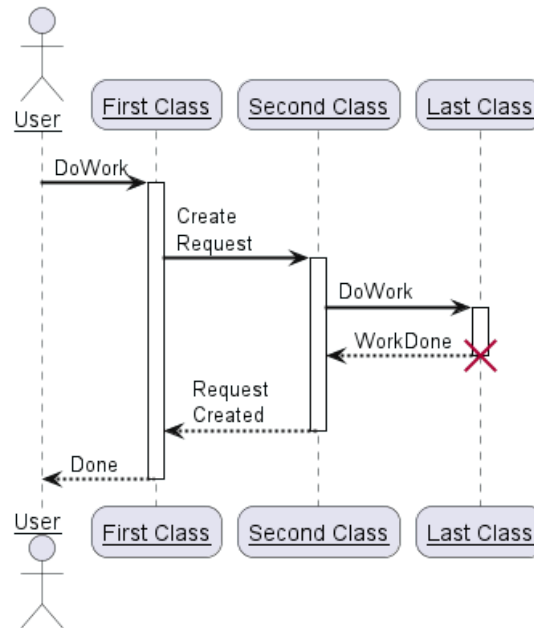

```

@startuml
skinparam backgroundColor #EEEBDC
skinparam handwritten true

skinparam sequence {
ArrowColor DeepSkyBlue
ActorBorderColor DeepSkyBlue
LifeLineBorderColor blue
LifeLineBackgroundColor #A9DCDF

ParticipantBorderColor DeepSkyBlue
ParticipantBackgroundColor DodgerBlue
ParticipantFontName Impact
ParticipantFontSize 17
ParticipantFontColor #A9DCDF

ActorBackgroundColor aqua
ActorFontColor DeepSkyBlue
ActorFontSize 17
ActorFontName Apex
}

actor User
participant "First Class" as A
participant "Second Class" as B
participant "Last Class" as C

User -> A: DoWork
activate A

A -> B: Create Request
activate B

B -> C: DoWork
activate C
C --> B: WorkDone
deactivate C

B --> A: Request Created
deactivate B

A --> User: Done
deactivate A
  
```



```

B --> A: Request Created
deactivate B

A --> User: Done
deactivate A

@enduml

```

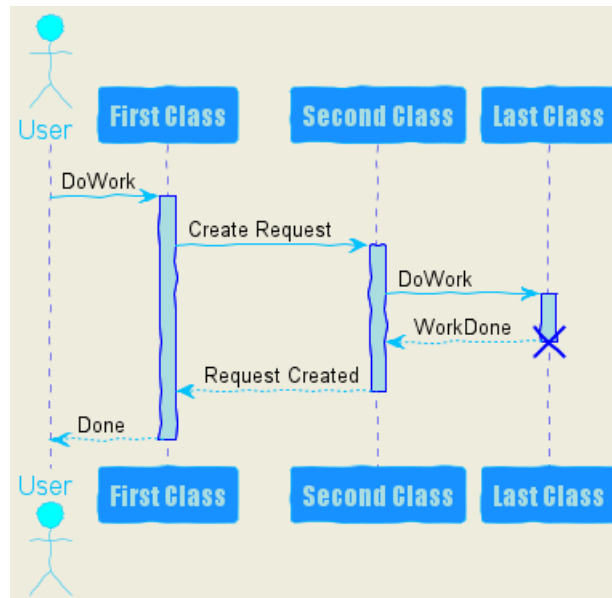

1.37 Changer le padding

Il est possible de changer certains paramètres du padding.

```

@startuml
skinparam ParticipantPadding 20
skinparam BoxPadding 10

box "Foo1"
participant Alice1
participant Alice2
end box
box "Foo2"
participant Bob1
participant Bob2
end box
Alice1 -> Bob1 : hello
Alice1 -> Out : out
@enduml

```

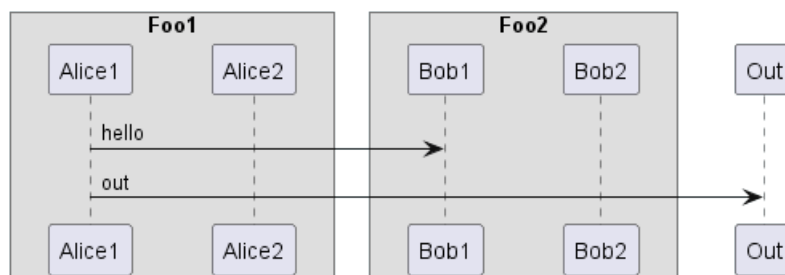

1.38 Appendix: Examples of all arrow type

1.38.1 Normal arrow

```

@startuml
participant Alice as a
participant Bob as b
a -> b : ""-> ""
a ->> b : ""->> ""
a -\ b : ""-\ ""
a -\\ b : ""-\\\\ ""
a -/ b : ""-/ ""
a -// b : ""-// ""
a ->x b : ""->x ""
a x-> b : ""x-> ""
a o-> b : ""o-> ""
a ->o b : ""->o ""
a o->o b : ""o->o ""
a <-> b : ""<-> ""
a o<->o b : ""o<->o ""
a x<->x b : ""x<->x ""
a ->>o b : ""->>o ""
a -\o b : ""-\o ""
a -\\o b : ""-\\\\o ""
a -/o b : ""-/o ""
a -//o b : ""-//o ""
a x->o b : ""x->o ""
@enduml

```

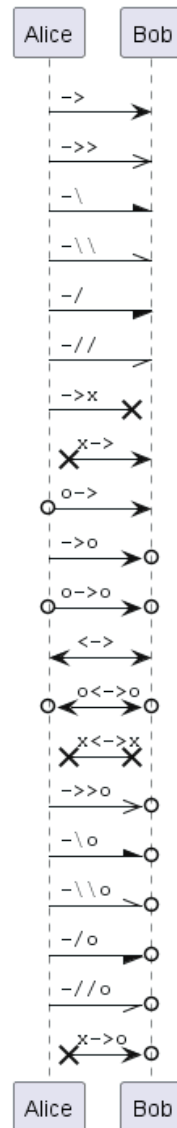

1.38.2 Itself arrow

```

@startuml
participant Alice as a
participant Bob as b
a -> a : ""-> ""
a ->> a : ""->> ""
a -\ a : ""-\ ""
a -\\ a : ""-\\ ""
a -/ a : ""-/ ""
a -// a : ""-// ""
a ->x a : ""->x ""
a x-> a : ""x-> ""
a o-> a : ""o-> ""
a ->o a : ""->o ""
a o->o a : ""o->o ""
a <-> a : ""<-> ""
a o<->o a : ""o<->o ""
a x<->x a : ""x<->x ""
a ->>o a : ""->>o ""
a -\o a : ""-\o ""
a -\\o a : ""-\\o ""

```



```

a -/o    a : ""-/o  ""
a -//o   a : ""-//o ""
a x->o   a : ""x->o ""
@enduml

```

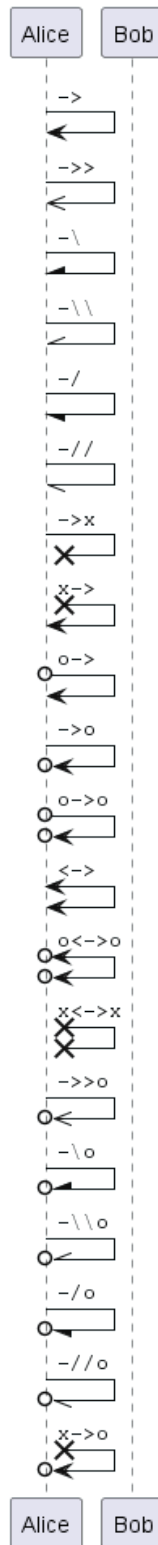

1.38.3 Incoming and outgoing messages (with '[', ']')

1.38.4 Incoming messages (with '[')

@startuml

```
participant Alice as a
participant Bob as b
[-> b : ""[-> ""
[->> b : ""[->> ""
[-\ b : ""[-\ ""
[-\\ b : ""[-\\\\ ""
[-/ b : ""[-/ ""
[-// b : ""[-// ""
[->x b : ""[->x ""
[x-> b : ""[x-> ""
[o-> b : ""[o-> ""
[->o b : ""[->o ""
[o->o b : ""[o->o ""
[<-> b : ""[<-> ""
[o<->o b : ""[o<->o""
[x<->x b : ""[x<->x""
[->>o b : ""[->>o ""
[-\o b : ""[-\o ""
[-\\o b : ""[-\\\\o""
[-/o b : ""[-/o ""
[-//o b : ""[-//o ""
[x->o b : ""[x->o ""
@enduml
```

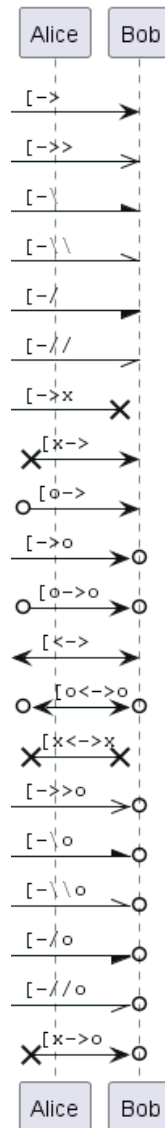

1.38.5 Outgoing messages (with '']')

```

@startuml
participant Alice as a
participant Bob as b
a ->] : ""->] ""
a ->>] : ""->>] ""
a -\] : ""-\] ""
a -\\] : ""-\\] ""
a -/] : ""-/] ""
a -//] : ""-//] ""
a ->x] : ""->x] ""
a x->] : ""x->] ""
a o->] : ""o->] ""
a ->o] : ""->o] ""
a o->o] : ""o->o] ""
a <->] : ""<->] ""
a o<->o] : ""o<->o] ""
a x<->x] : ""x<->x] ""
a ->>o] : ""->>o] ""
a -\o] : ""-\o] ""
a -\\o] : ""-\\o] ""

```



```

a -/o]      : ""-/o] ""
a -//o]     : ""-//o] ""
a x->o]     : ""x->o] ""
@enduml

```

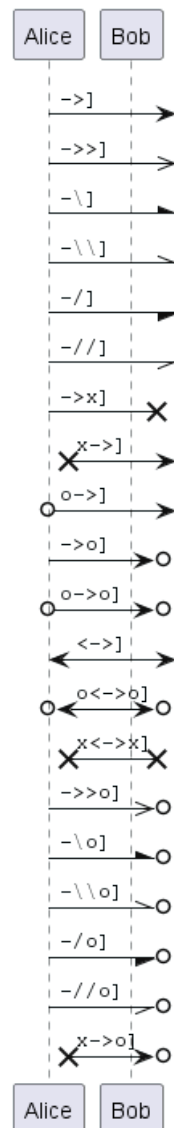

1.38.6 Short incoming and outgoing messages (with '?')

1.38.7 Short incoming (with '?')

```

@startuml
participant Alice as a
participant Bob as b
a -> b : //Long long label//
?-> b : ""?-> ""
?->> b : ""?->> ""
?-\ b : ""?-\ ""
?-\\ b : ""?-\\\\" ""
?-/ b : ""?-/ ""
?-// b : ""?-// ""
?->x b : ""?->x ""
?x-> b : ""?x-> ""
?o-> b : ""?o-> ""
?->o b : ""?->o ""

```



```
?o->o    b : ""?o->o ""  
?<->     b : ""?<-> ""  
?o<->o   b : ""?o<->o""  
?x<->x   b : ""?x<->x""  
?->>o    b : ""?->>o ""  
?-\o     b : ""?-\o  ""  
?-\ \o   b : ""?-\ \o ""  
?-/o     b : ""?-/o  ""  
?-//o    b : ""?-//o ""  
?x->o    b : ""?x->o ""  
@enduml
```

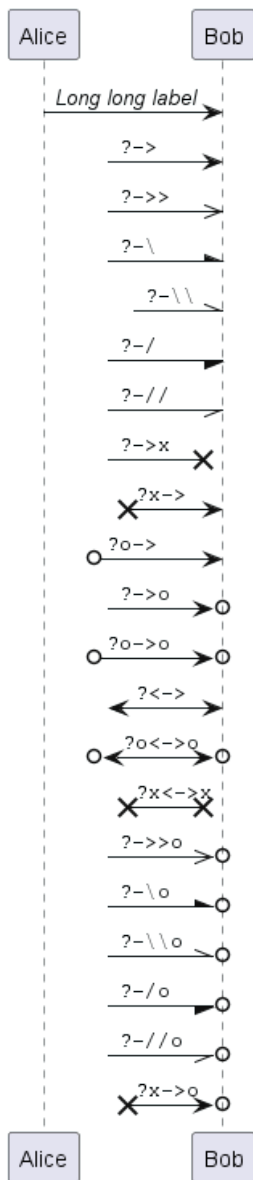

1.38.8 Short outgoing (with '?')

```
@startuml  
participant Alice as a  
participant Bob as b  
a ->> b : //Long long label//  
a ->? : ""->? ""  
a ->>? : ""->>? ""  
a -\? : ""-\? ""
```



```

a -\\?      : "\"-\\\\\\?\""
a -/?      : "\"-/?  \""
a -//?     : "\"-//?  \""
a ->x?     : "\"->x?  \""
a x->?     : "\"x->?  \""
a o->?     : "\"o->?  \""
a ->o?     : "\"->o?  \""
a o->o?    : "\"o->o?  \""
a <->?     : "\"<->?  \""
a o<->o?  : "\"o<->o?\""
a x<->x?  : "\"x<->x?\""
a ->>o?    : "\"->>o?  \""
a -\o?     : "\"-\o?   \""
a -\\o?    : "\"-\\\\o?  \""
a -/o?     : "\"-/o?   \""
a -//o?    : "\"-//o?  \""
a x->o?    : "\"x->o?  \""
@enduml

```

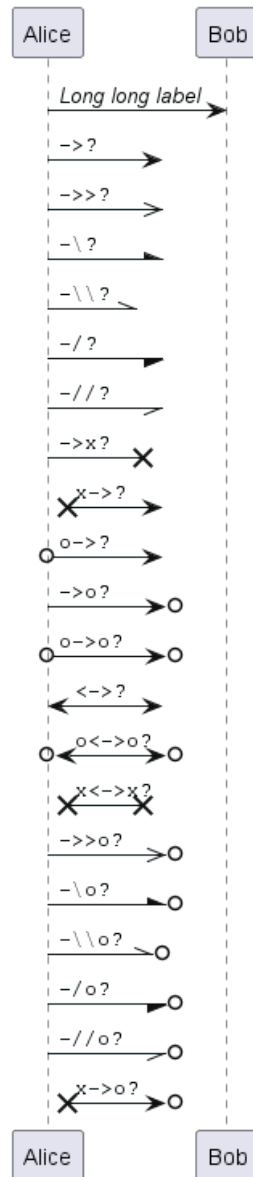

1.39 SkinParameter spécifique

1.39.1 Par défaut

```
@startuml
Bob -> Alice : hello
Alice -> Bob : ok
@enduml
```

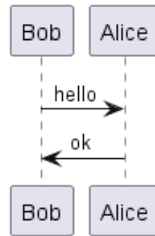

1.39.2 LifelineStrategy

- nosolid (*par défaut*)

```
@startuml
skinparam lifelineStrategy nosolid
Bob -> Alice : hello
Alice -> Bob : ok
@enduml
```

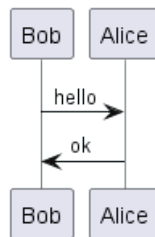

[Ref. QA-9016]

- solid

Pour avoir une ligne de vie solide dans les diagrammes de séquence, vous pouvez utiliser : `skinparam lifelineStrategy solid`

```
@startuml
skinparam lifelineStrategy solid
Bob -> Alice : hello
Alice -> Bob : ok
@enduml
```

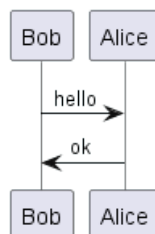

[Ref. QA-2794]

1.39.3 style strictuml

Pour être conforme à l'UML strict (*pour le style de flèche : émet un triangle plutôt que des pointes de flèche pointues*), vous pouvez utiliser



- `skinparam style strictuml`

```
@startuml
skinparam style strictuml
Bob -> Alice : hello
Alice -> Bob : ok
@enduml
```

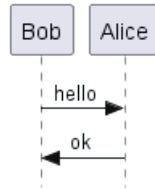

[Réf. QA-1047]

1.40 Masquer un participant non lié

Par défaut, tous les participants sont affichés

```
@startuml
participant Alice
participant Bob
participant Carol

Alice -> Bob : hello
@enduml
```

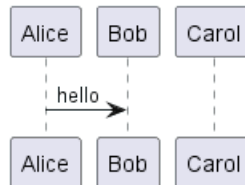

Mais vous pouvez `hide unlinked participant`

```
@startuml
hide unlinked
participant Alice
participant Bob
participant Carol

Alice -> Bob : hello
@enduml
```

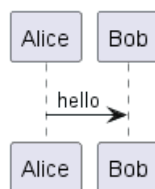

[Réf. QA-4247]

1.41 Colorier un groupe de message

Il est possible de colorer un groupe de message

```
@startuml
Alice -> Bob: Authentication Request
alt#Gold #LightBlue Successful case
```



```

    Bob -> Alice: Authentication Accepted
else #Pink Failure
    Bob -> Alice: Authentication Rejected
end
@enduml

```

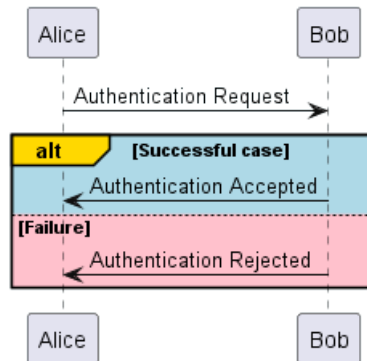

[Réf. QA-4750 et QA-6410]

1.42 Mainframe

```

@startuml
mainframe This is a **mainframe**
Alice->Bob : Hello
@enduml

```

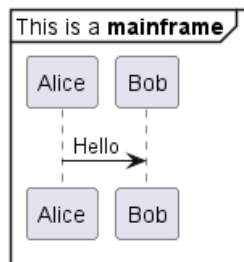

[Ref. QA-4019 and Issue#148]

1.43 Slanted or odd arrows

You can use the (nn) option (before or after arrow) to make the arrows slanted, where *nn* is the number of shift pixels.

[Available only after v1.2022.6beta+]

```

@startuml
A ->(10) B: text 10
B ->(10) A: text 10

A ->(10) B: text 10
A (10)<- B: text 10
@enduml

```



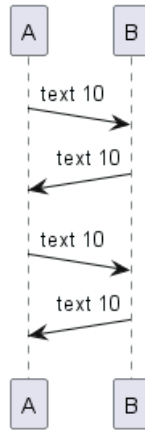

```
@startuml
A ->(40) B++: Rq
B -->(20) A--: Rs
@enduml
```

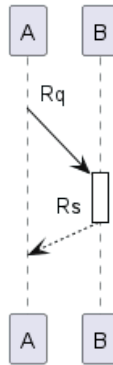

[Ref. QA-14145]

```
@startuml
!pragma teoz true
A ->(50) C: Starts\nwhen 'B' sends
& B ->(25) C: \nBut B's message\n arrives before A's
@enduml
```

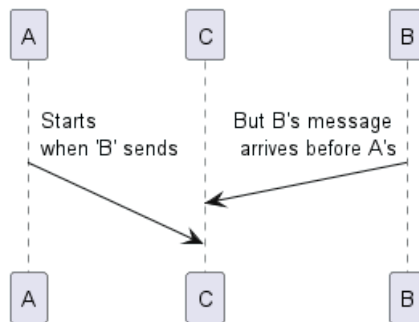

[Ref. QA-6684]

```
@startuml
!pragma teoz true

S1 ->(30) S2: msg 1\n
& S2 ->(30) S1: msg 2

note left S1: msg\nS2 to S1
& note right S2: msg\nS1 to S2
```



@enduml

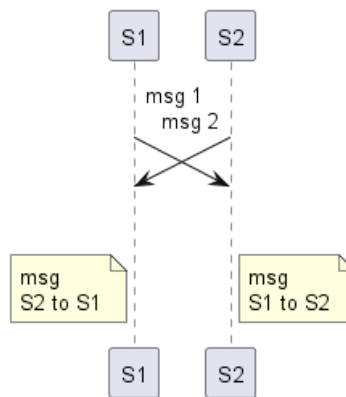

[Ref. QA-1072]

2 Diagramme de cas d'utilisation

Prenons quelques exemples

PlantUML offers a unique approach to creating use case diagrams through its text-based language. One of the primary advantages of using PlantUML is its **simplicity and efficiency**. Instead of manually drawing shapes and connections, users can define their diagrams using intuitive and concise textual descriptions. This not only speeds up the diagram creation process but also ensures **consistency and accuracy**. The ability to integrate with various documentation platforms and its wide range of supported output formats make PlantUML a versatile tool for both developers and non-developers. Lastly, being **open-source**, PlantUML boasts a [strong community](https://forum.plantuml.net/) that continually contributes to its improvement and offers a wealth of resources for users at all levels.

2.1 Cas d'utilisation

Les cas d'utilisation sont mis entre parenthèses (car deux parenthèses forment un ovale).

Vous pouvez aussi utiliser le mot-clé `usecase` pour définir un cas d'utilisation. Et vous pouvez définir un alias avec le mot-clé `as`. Cet alias sera ensuite utilisé lors de la définition des relations.

```
@startuml
(First usecase)
(Another usecase) as (UC2)
usecase UC3
usecase (Last\nusecase) as UC4
@enduml
```

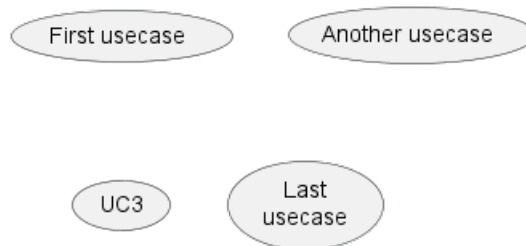

2.2 Acteurs

Le nom définissant un acteur est placé entre deux points.

Vous pouvez également utiliser le mot-clé `actor` pour définir un acteur. Un alias peut être attribué à l'aide du mot-clé `as` et peut être utilisé ultérieurement à la place du nom de l'acteur, par exemple lors de la définition des relations.

Les exemples suivants montrent que la définition des acteurs est facultative.

```
@startuml
:First Actor:
:Another\nactor: as Man2
actor Woman3
actor :Last actor: as Person1
@enduml
```



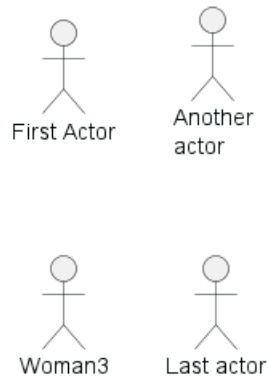

2.3 Change Actor style

You can change the actor style from stick man (*by default*) to:

- an awesome man with the `skinparam actorStyle awesome` command;
- a hollow man with the `skinparam actorStyle hollow` command.

2.3.1 Stick man (*by default*)

```
@startuml
:User: --> (Use)
"Main Admin" as Admin
"Use the application" as (Use)
Admin --> (Admin the application)
@enduml
```

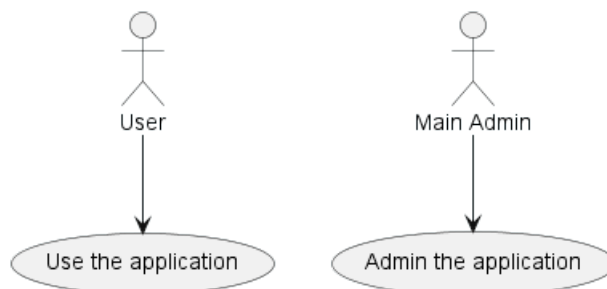

2.3.2 Awesome man

```
@startuml
skinparam actorStyle awesome
:User: --> (Use)
"Main Admin" as Admin
"Use the application" as (Use)
Admin --> (Admin the application)
@enduml
```

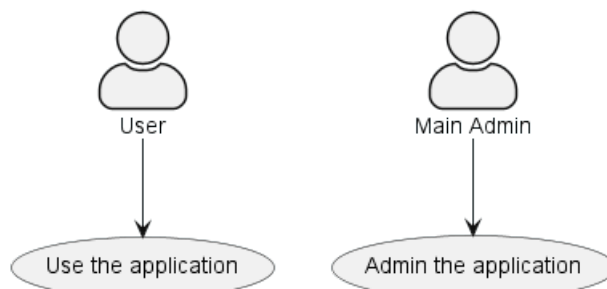

[Ref. QA-10493]

2.3.3 Hollow man

```
@startuml
skinparam actorStyle Hollow
:User: --> (Use)
"Main Admin" as Admin
"Use the application" as (Use)
Admin --> (Admin the application)
@enduml
```

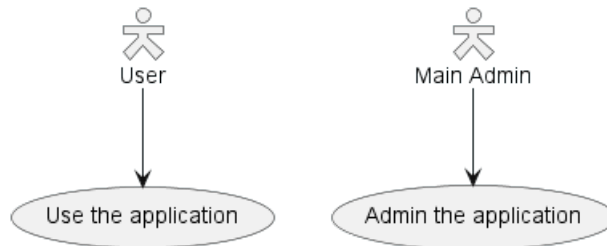

[Ref. PR#396]

2.4 Description des cas d'utilisation

Si vous voulez une description sur plusieurs lignes, vous pouvez utiliser des guillemets.

Vous pouvez aussi utiliser les séparateurs suivants: -- .. == __. Et vous pouvez mettre un titre dans les séparateurs.

```
@startuml
usecase UC1 as "You can use
several lines to define your usecase.
You can also use separators.
--
Several separators are possible.
==
And you can add titles:
..Conclusion..
This allows large description."
@enduml
```

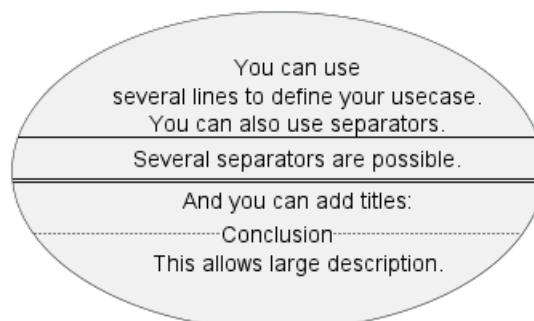

2.5 Utiliser un package

Vous pouvez utiliser des packages pour regrouper des acteurs ou des cas d'utilisation

```
@startuml
left to right direction
```



```

actor Guest as g
package Professional {
  actor Chef as c
  actor "Food Critic" as fc
}
package Restaurant {
  usecase "Eat Food" as UC1
  usecase "Pay for Food" as UC2
  usecase "Drink" as UC3
  usecase "Review" as UC4
}
fc --> UC4
g --> UC1
g --> UC2
g --> UC3
@enduml

```

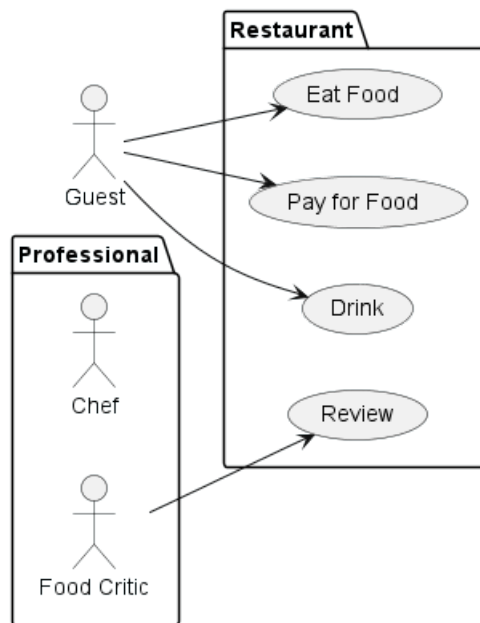

Vous pouvez utiliser rectangle pour modifier l'affichage du paquet

```

@startuml
left to right direction
actor "Food Critic" as fc
rectangle Restaurant {
  usecase "Eat Food" as UC1
  usecase "Pay for Food" as UC2
  usecase "Drink" as UC3
}
fc --> UC1
fc --> UC2
fc --> UC3
@enduml

```

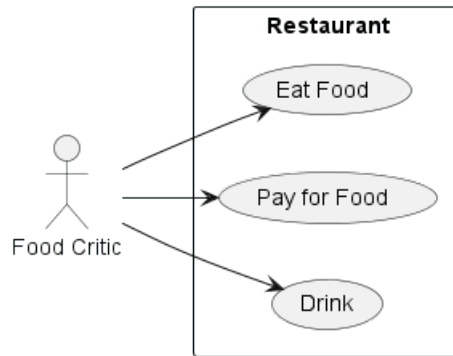

2.6 Exemples très simples

Pour lier les acteurs et les cas d'utilisation, la flèche --> est utilisée.

Plus il y a de tirets - dans la flèche, plus elle sera longue. Vous pouvez ajouter un libellé sur la flèche, en ajoutant un caractère : dans la définition de la flèche.

Dans cet exemple, vous voyez que *User* n'a pas été défini préalablement, et qu'il est implicitement reconnu comme acteur.

```
@startuml
```

```
User -> (Start)
```

```
User --> (Use the application) : A small label
```

```
:Main Admin: ---> (Use the application) : This is\nyet another\nlabel
```

```
@enduml
```

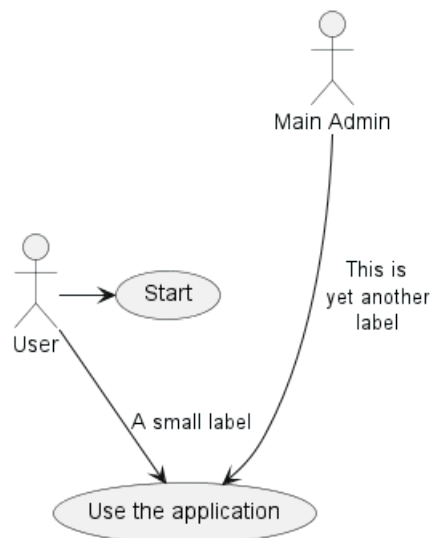

2.7 Héritage

Si un acteur ou un cas d'utilisation en étend un autre, vous pouvez utiliser le symbole <|--.

```
@startuml
```

```
:Main Admin: as Admin
```

```
(Use the application) as (Use)
```

```
User <|-- Admin
```

```
(Start) <|-- (Use)
```



```
@enduml
```

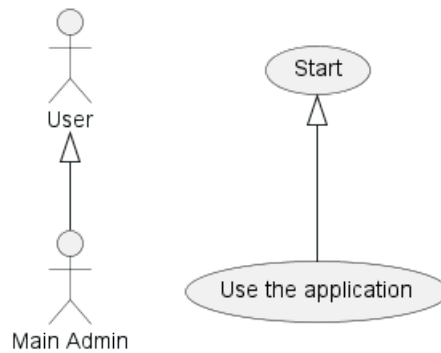

2.8 Notes

Vous pouvez utiliser les mots clés `note left of`, `note right of`, `note top of`, `note bottom of` pour définir les notes en relation avec un objet.

Une note peut également être définie seule avec des mots-clés, puis liée à d'autres objets en utilisant le symbole `..`.

```
@startuml
:Main Admin: as Admin
(Use the application) as (Use)
```

```
User -> (Start)
User --> (Use)
```

```
Admin ---> (Use)
```

```
note right of Admin : This is an example.
```

```
note right of (Use)
  A note can also
  be on several lines
end note
```

```
note "This note is connected\nto several objects." as N2
(Start) .. N2
N2 .. (Use)
@enduml
```

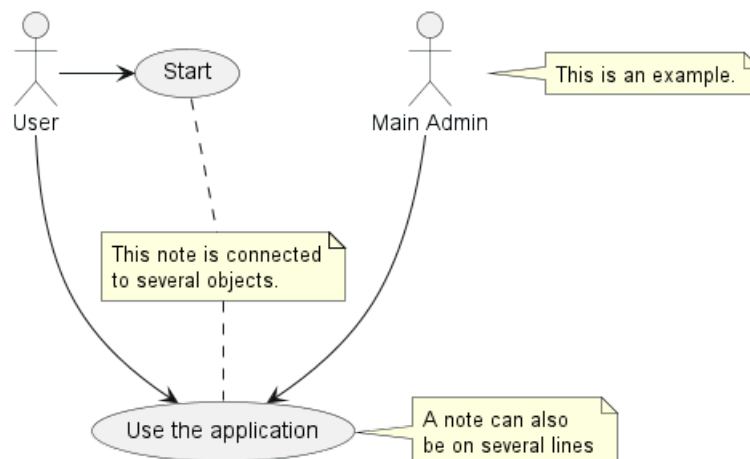

2.9 Stéréotypes

Vous pouvez ajouter des stéréotypes à la définition des acteurs et des cas d'utilisation avec << et >>.

```
@startuml
User << Human >>
:Main Database: as MySQL << Application >>
(Start) << One Shot >>
(Use the application) as (Use) << Main >>

User -> (Start)
User --> (Use)

MySQL --> (Use)

@enduml
```

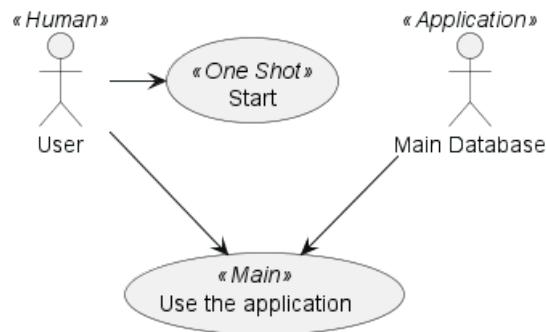

2.10 Changer les directions des flèches

Par défaut, les liens entre les classes ont deux tirets -- et sont orientés verticalement. Il est possible de mettre des liens horizontaux en mettant un seul tiret (ou un point) comme ceci:

```
@startuml
:user: --> (Use case 1)
:user: -> (Use case 2)
@enduml
```

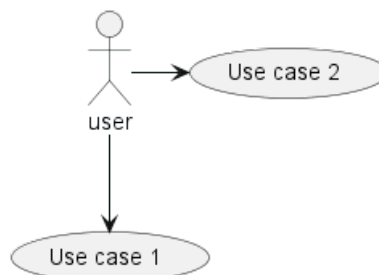

Vous pouvez aussi changer le sens en renversant le lien :

```
@startuml
(Use case 1) <.. :user:
(Use case 2) <- :user:
@enduml
```

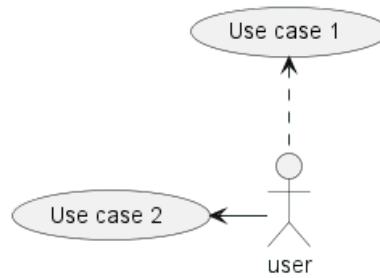

Il est possible de changer la direction d'une flèche en utilisant les mots-clé `left`, `right`, `up` ou `down` à l'intérieur de la flèche :

```

@startuml
:user: -left-> (dummyLeft)
:user: -right-> (dummyRight)
:user: -up-> (dummyUp)
:user: -down-> (dummyDown)
@enduml
  
```

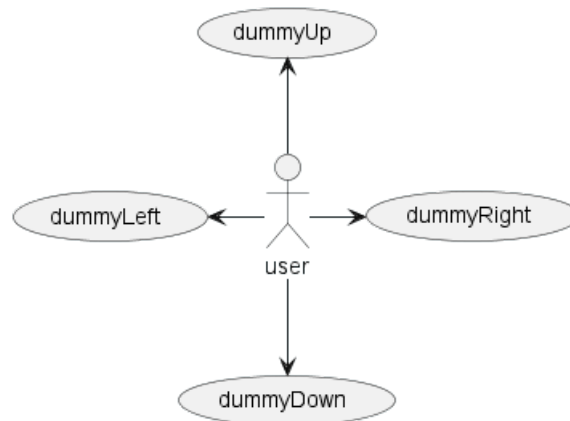

Vous pouvez abrégier les noms des flèches en indiquant seulement le premier caractère de la direction (par exemple `-d-` pour `-down-`) ou les deux premiers caractères (`-do-`).

Il est conseillé de ne pas abuser de cette fonctionnalité : *Graphviz* qui donne d'assez bon résultats quoique non "garantis".

2.11 Découper les diagrammes

Le mot-clé `newpage` est utilisé pour découper un diagramme en plusieurs images.

```

@startuml
:actor1: --> (Usecase1)
newpage
:actor2: --> (Usecase2)
@enduml
  
```

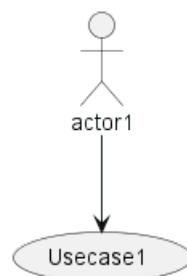

2.12 De droite à gauche

Le comportement général de construction des diagrammes est de haut en bas.

```
@startuml
'default
top to bottom direction
user1 --> (Usecase 1)
user2 --> (Usecase 2)

@enduml
```

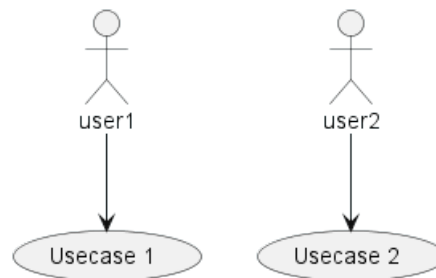

Il est possible de changer pour aller plutôt de la droite vers la gauche avec la commande `left to right direction`. Le résultat est parfois meilleur dans ce cas.

```
@startuml

left to right direction
user1 --> (Usecase 1)
user2 --> (Usecase 2)

@enduml
```

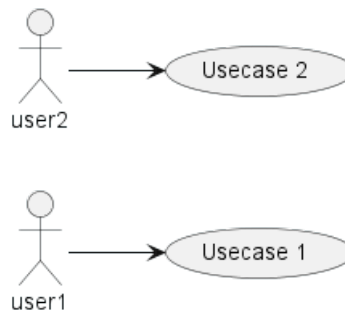

2.13 La commande Skinparam

Utilisez la commande `skinparam` pour changer la couleur et la mise en forme du texte du schéma.

Vous pouvez utiliser cette commande :

- Dans la définition du diagramme, comme pour les autres commandes,
- Dans un fichier inclus,
- Dans un fichier de configuration, renseigné dans la ligne de commande ou la tâche ANT.

Vous pouvez aussi spécifier les polices et les couleurs pour les acteurs et cas d'utilisation avec des stéréotypes.

```
@startuml
skinparam handwritten true

skinparam usecase {
BackgroundColor DarkSeaGreen
```



```

BorderColor DarkSlateGray

BackgroundColor<< Main >> YellowGreen
BorderColor<< Main >> YellowGreen

ArrowColor Olive
ActorBorderColor black
ActorFontName Courier

ActorBackgroundColor<< Human >> Gold
}

User << Human >>
:Main Database: as MySQL << Application >>
(Start) << One Shot >>
(Use the application) as (Use) << Main >>

User -> (Start)
User --> (Use)

MySQL --> (Use)

@enduml

```

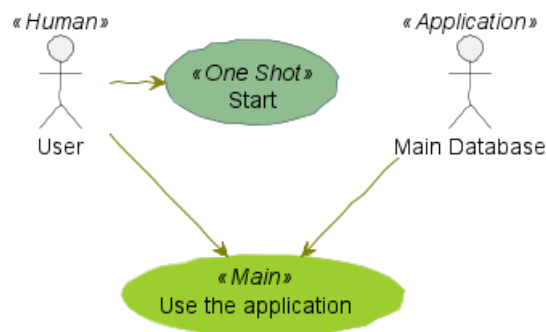

2.14 Exemple complet

```

@startuml
left to right direction
skinparam packageStyle rectangle
actor customer
actor clerk
rectangle checkout {
customer -- (checkout)
(checkout) .> (payment) : include
(help) .> (checkout) : extends
(checkout) -- clerk
}
@enduml

```

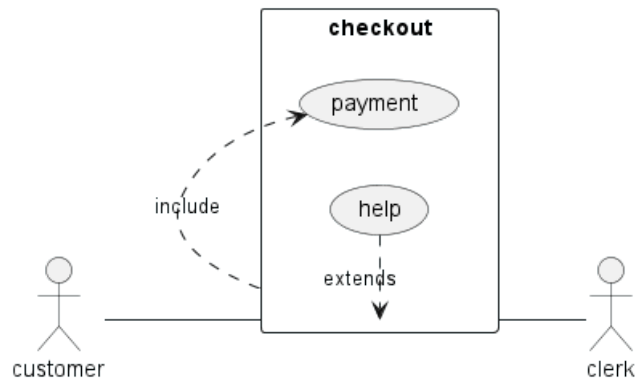
2.15 Business Use Case

Vous pouvez ajouter / pour créer un Business Use Case.

2.15.1 Business Use Case

```
@startuml
```

```
(First usecase)/
(Another usecase)/ as UC2
usecase/ UC3
usecase/ (Last\nusecase) as UC4
```

```
@enduml
```

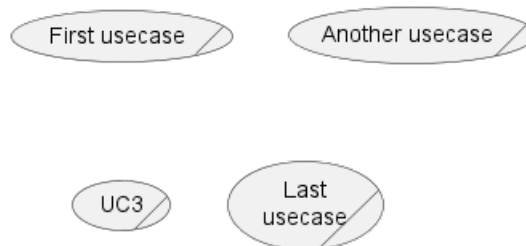

2.15.2 Acteur commercial

```
@startuml
```

```
:First Actor:/
:Another\nactor:/ as Man2
actor/ Woman3
actor/ :Last actor: as Person1
```

```
@enduml
```

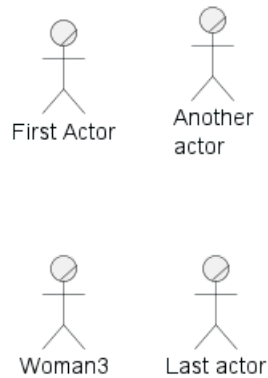

[Réf. QA-12179]

2.16 Modifier la couleur et le style des flèches (style en ligne)

Vous pouvez modifier la couleur ou le style des flèches individuelles en utilisant la notation suivante en ligne

- `#color;line.[bold|dashed|dotted];text:color`

```
@startuml
actor foo
foo --> (bar) : normal
foo --> (bar1) #line:red;line.bold;text:red : red bold
foo --> (bar2) #green;line.dashed;text:green : green dashed
foo --> (bar3) #blue;line.dotted;text:blue : blue dotted
@enduml
```

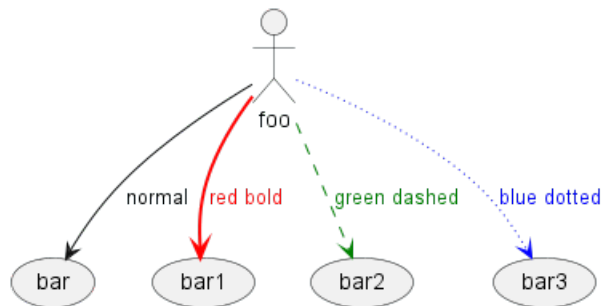

[Réf. QA-3770 et QA-3816] [Voir une fonctionnalité similaire sur le diagramme de déploiement ou le diagramme de classes]

2.17 Modifier la couleur et le style d'un élément (style en ligne)

Vous pouvez modifier la couleur ou le style d'un élément individuel en utilisant la notation suivante

- `#[color|back:color];line:color;line.[bold|dashed|dotted];text:color`

```
@startuml
actor a
actor b #pink;line:red;line.bold;text:red
usecase c #palegreen;line:green;line.dashed;text:green
usecase d #aliceblue;line:blue;line.dotted;text:blue
@enduml
```

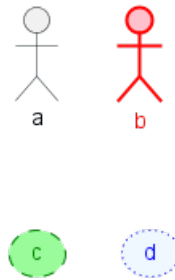

[Réf. QA-5340 et adapté de QA-6852]

2.18 Display JSON Data on Usecase diagram

2.18.1 Simple example

```
@startuml
allowmixing

actor Actor
usecase Usecase

json JSON {
  "fruit": "Apple",
  "size": "Large",
  "color": ["Red", "Green"]
}
@enduml
```



JSON	
fruit	Apple
size	Large
color	Red
	Green

[Ref. QA-15481]

For another example, see on JSON page.

3 Diagramme de classes

Les diagrammes de classes sont conçus à l'aide d'une syntaxe qui reflète celle traditionnellement employée dans les langages de programmation. Cette ressemblance favorise un environnement familier pour les développeurs, facilitant ainsi un processus de création de diagrammes plus facile et plus intuitif.

Cette approche de la conception est non seulement succincte, mais elle permet également de créer des représentations à la fois concises et expressives. De plus, elle permet la représentation des relations entre les classes à travers une syntaxe qui fait écho à celle des diagrammes de séquence, ouvrant la voie à une représentation fluide et perspiciace des interactions entre les classes.

Au-delà des représentations structurales et relationnelles, la syntaxe des diagrammes de classes supporte d'autres enrichissements tels que l'inclusion de notes et l'application de couleurs, permettant aux utilisateurs de créer des diagrammes qui sont à la fois informatifs et visuellement attrayants.

Vous pouvez en apprendre plus sur certaines des commandes communes dans PlantUML pour améliorer votre expérience de création de diagrammes.

3.1 Déclaration d'un élément

```
@startuml
abstract      abstract
abstract class "abstract class"
annotation    annotation
circle        circle
()            circle_short_form
class         class
diamond       diamond
<>           diamond_short_form
entity        entity
enum          enum
interface     interface
@enduml
```

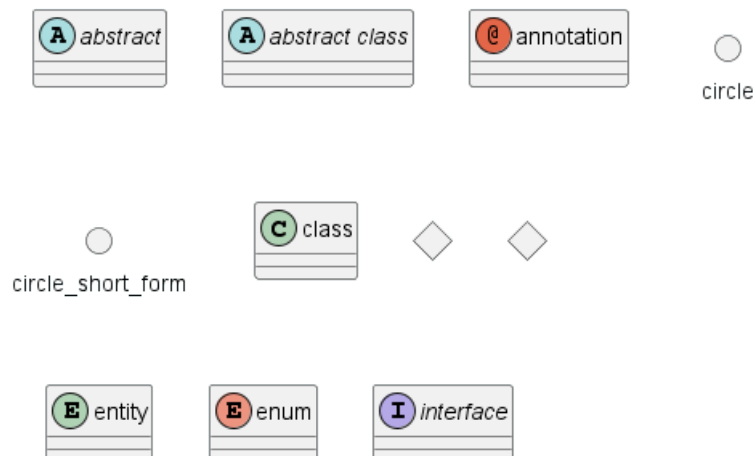

[Ref. for “protocol“ and “struct“: [GH-1028](<https://github.com/plantuml/plantuml/pull/1028>)]

[Ref. for “protocol“ and “struct“: [GH-1028](<https://github.com/plantuml/plantuml/pull/1028>), for “exception“: [QA-16258](<https://forum.plantuml.net/16258/adding-exception-keyword-for-class-diagram>)]

3.2 Relations entre classes

Les relations entre les classes sont définies en utilisant les symboles suivants :



Type	Symbol	Drawing
Extension	< --	
Composition	*--	
Aggregation	o--	

Il est possible de substituer -- par .. pour obtenir une ligne en pointillée.

Grâce à ces règles, il est possible de faire les diagrammes suivants :

```
@startuml
Class01 <|-- Class02
Class03 *-- Class04
Class05 o-- Class06
Class07 .. Class08
Class09 -- Class10
@enduml
```

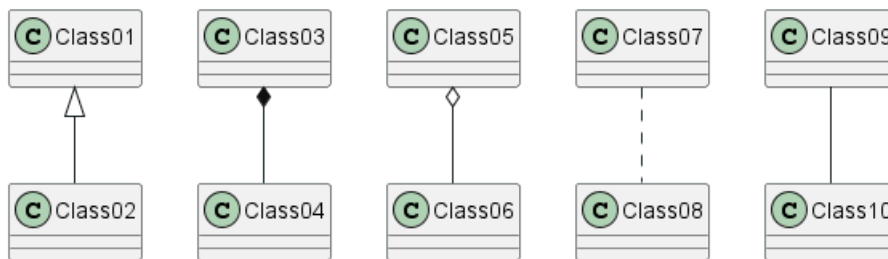

```
@startuml
Class11 <|.. Class12
Class13 --> Class14
Class15 ..> Class16
Class17 ..|> Class18
Class19 <--* Class20
@enduml
```

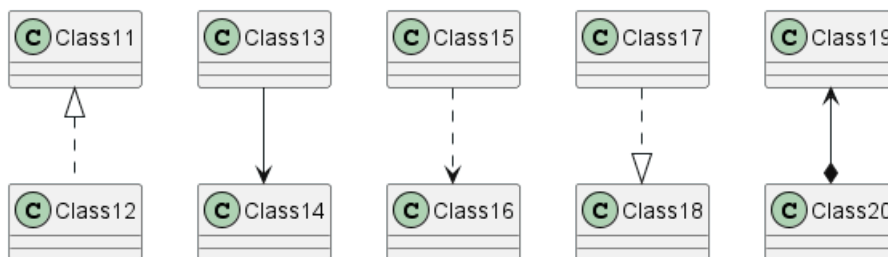

```
@startuml
Class21 #-- Class22
Class23 x-- Class24
Class25 }-- Class26
Class27 +-- Class28
Class29 ^-- Class30
@enduml
```

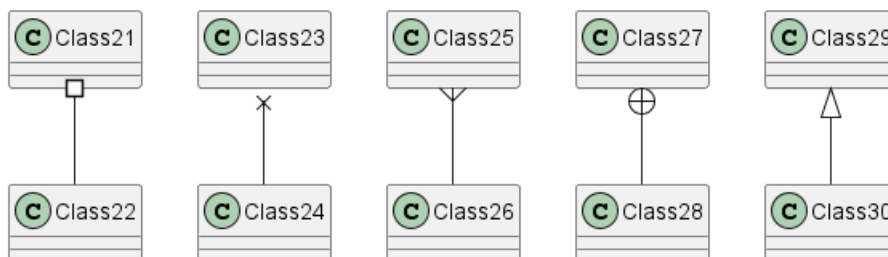

3.3 Libellés sur les relations

Il est possible de rajouter un libellé sur une relation, en utilisant les deux points :, suivi du texte du libellé.

Pour les cardinalité, vous pouvez utiliser des guillemets "" des deux cotés de la relation.

```
@startuml
Class01 "1" *-- "many" Class02 : contains

Class03 o-- Class04 : aggregation

Class05 --> "1" Class06
@enduml
```

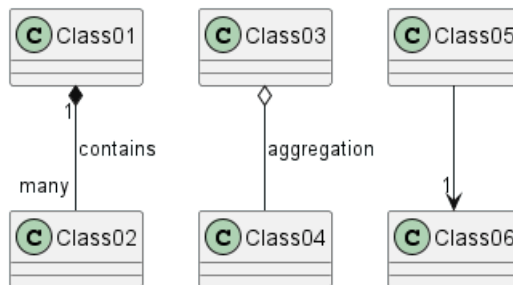

Vous pouvez ajouter une flèche désignant quel objet agit sur l'autre en utilisant < ou > au début ou à la fin du libellé.

```
@startuml
class Car

Driver - Car : drives >
Car *- Wheel : have 4 >
Car -- Person : < owns

@enduml
```

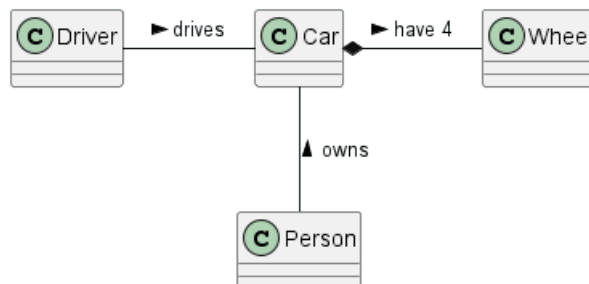

3.4 Caractères non alphabétiques

Si vous voulez utiliser autre chose que des lettres dans les classes (ou les enums...), vous pouvez:

- Utiliser le mot clé `as` dans la définition de la classe
- Mettre des guillemets "" autour du nom de la classe

```
@startuml
class "This is my class" as class1
class class2 as "It works this way too"

class2 *-- "foo/dummy" : use
@enduml
```



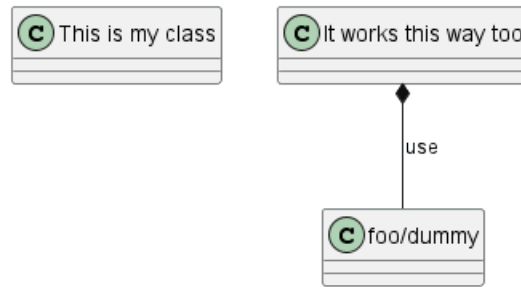

Also note that names starting with \$ are valid, but to assign an alias to such element the name must be put between quotes "".

3.5 Définir les méthodes

Pour déclarer des méthodes ou des champs, vous pouvez utiliser le caractère : suivi de la méthode ou du champ.

Le système utilise la présence de parenthèses pour choisir entre méthodes et champs.

```

@startuml
Object <|-- ArrayList

Object : equals()
ArrayList : Object[] elementData
ArrayList : size()

@enduml
  
```

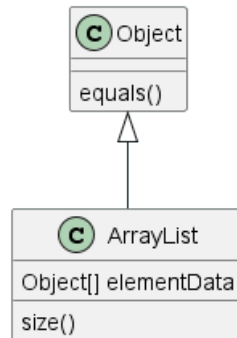

Il est possible de regrouper tous les champs et méthodes en utilisant des crochets {}.

Notez que la syntaxe est très souple sur l'ordre des champs et des méthodes.

```

@startuml
class Dummy {
    String data
    void methods()
}

class Flight {
    flightNumber : Integer
    departureTime : Date
}

@enduml
  
```



You can use `{field}` and `{method}` modifiers to override default behaviour of the parser about fields and methods.

```
@startuml
class Dummy {
  {field} A field (despite parentheses)
  {method} Some method
}
@enduml
```

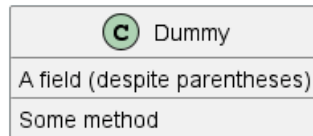

3.6 Définition de la visibilité

Lorsque vous définissez des méthodes ou des champs, vous pouvez utiliser des caractères pour définir la visibilité de l'élément correspondant

Caractère	Icône pour le champ	Icône de la méthode	Visibilité
-	□	■	private
#	◇	◆	protected
~	△	▲	package private
+	○	●	public

```
@startuml
class Dummy {
  -field1
  #field2
  ~method1()
  +method2()
}
@enduml
```

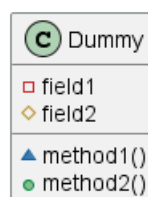

Vous pouvez désactiver cette fonctionnalité à l'aide de la commande `skinparam classAttributeIconSize 0`:

```
@startuml
skinparam classAttributeIconSize 0
class Dummy {
  -field1
  #field2
  ~method1()
  +method2()
}
@enduml
```





3.7 Abstrait et statique

Vous pouvez définir une méthode statique ou abstraite ou un champ utilisant `{static}` ou `{abstract}` modificateur.

Ce modificateur peut être utilisé au début ou à la fin de la ligne. Vous pouvez alors utiliser `{classifier}` plutôt que `{static}`.

```

@startuml
class Dummy {
    {static} String id
    {abstract} void methods()
}
@enduml
  
```

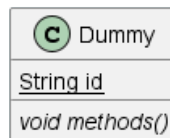

3.8 Corps de classe avancé

Par défaut, méthodes et champs sont automatiquement regroupés par PlantUML. Vous pouvez utiliser un séparateur pour définir votre propre manière d'ordonner les champs et les méthodes. Les séparateurs suivants sont possibles : `--` `..` `==` `__`.

Vous pouvez aussi utiliser les titres dans les séparateurs.

```

@startuml
class Foo1 {
    You can use
    several lines
    ..
    as you want
    and group
    ==
    things together.
    --
    You can have as many groups
    as you want
    --
    End of class
}

class User {
    .. Simple Getter ..
    + getName()
    + getAddress()
    .. Some setter ..
    + setName()
    __ private data __
    int age
}
  
```



```

-- encrypted --
String password
}
@enduml

```

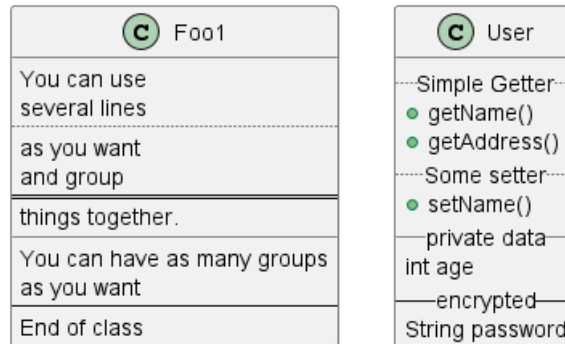

3.9 Notes et stéréotypes

Stéréotypes sont définies avec le mot clé `class`, `<<` et `>>`.

Vous pouvez aussi définir une note en utilisant les mots clés `note left of`, `note right of`, `note top of`, `note bottom of`.

Vous pouvez aussi définir une note sur la dernière classe utilisant `note left`, `note right`, `note top`, `note bottom`.

Une note peut aussi être définie le mot clé `note`, puis être lié à un autre objet en utilisant le symbole `..`

```

@startuml
class Object << general >>
Object <|--- ArrayList

note top of Object : In java, every class\nnextends this one.

note "This is a floating note" as N1
note "This note is connected\nto several objects." as N2
Object .. N2
N2 .. ArrayList

class Foo
note left: On last defined class

@enduml

```

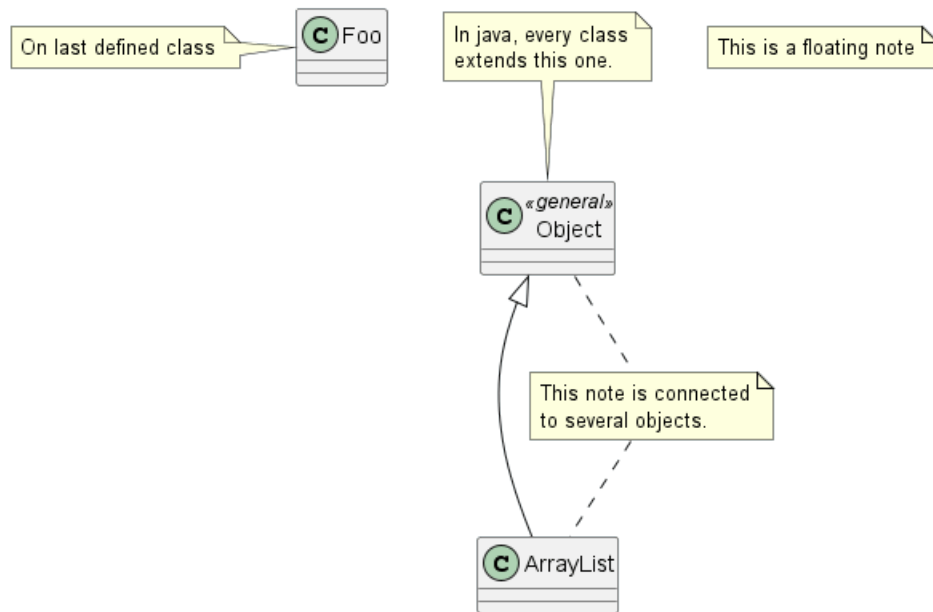

3.10 Plus de notes

Il est également possible d'utiliser quelques balises HTML (voir expression créole) comme

- ``
- `<u>`
- `<i>`
- `<s>` , ``, `<strike>`
- `` ou ``
- `<color:#AAAAAA>` ou `<color:colorName>`
- `<size:nn>` pour changer la taille de la police
- `` ou `<img:file>`: le fichier doit être accessible par le système de fichiers

Vous pouvez aussi avoir une note sur plusieurs lignes.

Vous pouvez aussi définir une note sur la dernière classe définie en utilisant `note left`, `note right`, `note top`, `note bottom`

```
@startuml
```

```
class Foo
note left: On last defined class
```

```
note top of Foo
  In java, <size:18>every</size> <u>class</u>
  <b>extends</b>
  <i>this</i> one.
end note
```

```
note as N1
  This note is <u>also</u>
  <b><color:royalBlue>on several</color>
  <s>words</s> lines
  And this is hosted by <img:sourceforge.jpg>
end note
```



```
@enduml
```

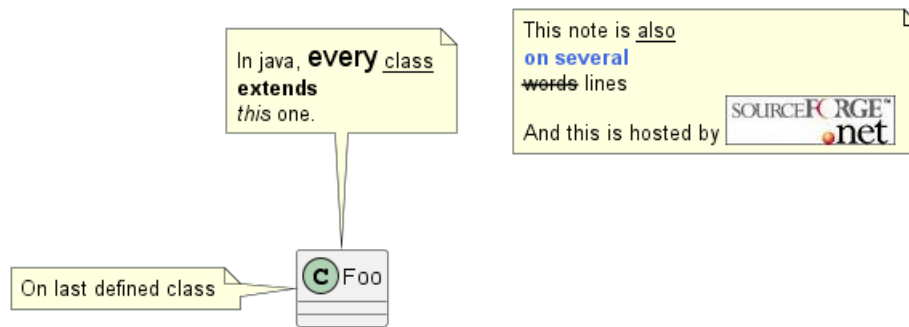

3.11 Note sur un champ (champ, attribut, membre) ou une méthode

Il est possible d'ajouter une note sur un champ (champ, attribut, membre) ou une méthode.

3.11.1 Note sur un champ ou une méthode

```
@startuml
class A {
{static} int counter
+void {abstract} start(int timeout)
}
note right of A::counter
  This member is annotated
end note
note right of A::start
  This method is now explained in a UML note
end note
@enduml
```

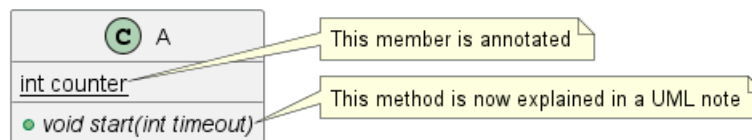

3.11.2 Note sur une méthode de même nom

```
@startuml
class A {
{static} int counter
+void {abstract} start(int timeoutms)
+void {abstract} start(Duration timeout)
}
note left of A::counter
  This member is annotated
end note
note right of A::"start(int timeoutms)"
  This method with int
end note
note right of A::"start(Duration timeout)"
  This method with Duration
end note
@enduml
```

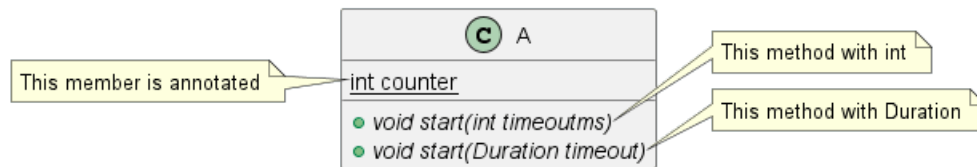

[Réf. QA-3474 et QA-5835]

3.12 Note sur les liens

Il est possible d'ajouter une note sur un lien, juste après la définition d'un lien, utiliser `note on link`.

Vous pouvez aussi utiliser `note left on link`, `note right on link`, `note top on link`, `note bottom on link` si vous voulez changer la position relative de la note avec l'étiquette.

```
@startuml
class Dummy
Dummy --> Foo : A link
note on link #red: note that is red

Dummy --> Foo2 : Another link
note right on link #blue
this is my note on right link
and in blue
end note
@enduml
```

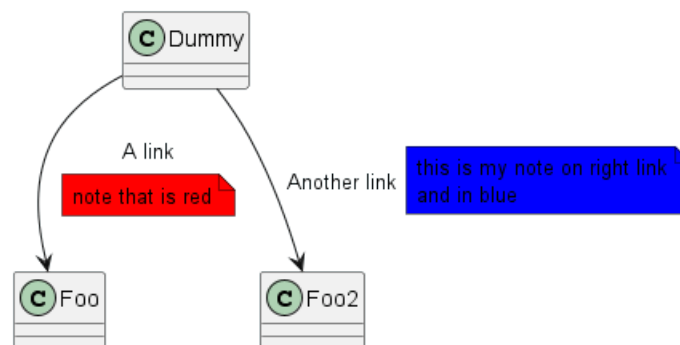

3.13 Classe et interface abstraites

Vous pouvez déclarer une classe abstraite à l'aide des mots-clés `abstract` ou `abstract class`.

La classe sera imprimée en *italique*.

Vous pouvez également utiliser les mots-clés `interface`, `annotation` et `enum`

```
@startuml
abstract class AbstractList
abstract AbstractCollection
interface List
interface Collection

List <|-- AbstractList
Collection <|-- AbstractCollection

Collection <|-- List
AbstractCollection <|-- AbstractList
@enduml
```



```

AbstractList <|-- ArrayList

class ArrayList {
    Object[] elementData
    size()
}

enum TimeUnit {
    DAYS
    HOURS
    MINUTES
}

annotation SuppressWarnings

annotation Annotation {
    annotation with members
    String foo()
    String bar()
}

@enduml

```

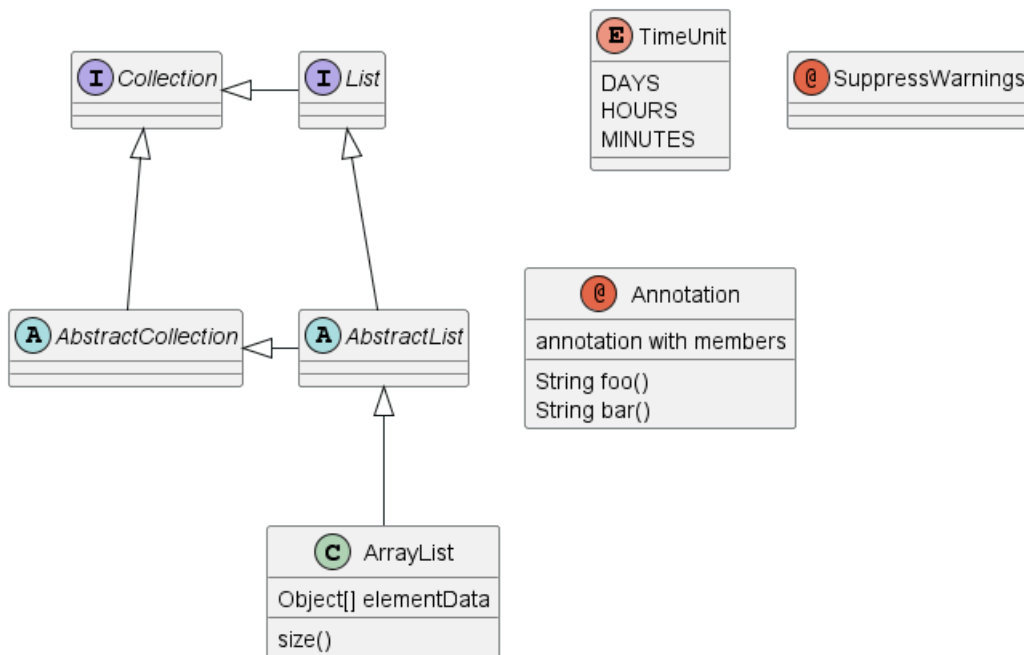

[Ref. 'Annotation with members' Issue#458]

3.14 Masquer les attributs et les méthodes

Vous pouvez paramétrer l'affichage des classes à l'aide de la commande `hide/show`.

La commande de base est: `hide empty members`. Cette commande va masquer la zone des champs ou des méthodes si celle-ci est vide.

A la place de `empty members`, vous pouvez utiliser:

- `empty fields` ou `empty attributes` pour des champs vides,
- `empty methods` pour des méthodes vides,
- `fields or attributes` qui masque les champs, même s'il y en a de définis,



- **methods** qui masque les méthodes, même s'il y en a de définies,
- **members** qui masque les méthodes ou les champs, même s'il y en a de définies,
- **circle** pour le caractère entouré en face du nom de la classe,
- **stereotype** pour le stéréotype.

Vous pouvez aussi fournir, juste après le mot-clé **hide** ou **show** :

- **class** pour toutes les classes,
- **interface** pour toutes les interfaces,
- **enum** pour tous les enums,
- **<<foo1>>** pour les classes qui sont stéréotypée avec *foo1*,
- Un nom de classe existant

Vous pouvez utiliser plusieurs commandes **show/hide** pour définir des règles et des exceptions.

```
@startuml
```

```
class Dummy1 {
    +myMethods()
}
```

```
class Dummy2 {
    +hiddenMethod()
}
```

```
class Dummy3 <<Serializable>> {
    String name
}
```

```
hide members
```

```
hide <<Serializable>> circle
```

```
show Dummy1 methods
```

```
show <<Serializable>> fields
```

```
@enduml
```

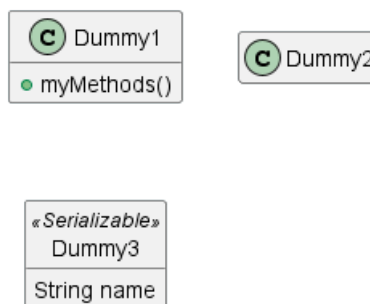

3.15 Masquer les classes

Vous pouvez également utiliser les commandes **show/hide** pour masquer les classes.

Cela peut être utile si vous définissez un grand fichier **!inclus**, et si vous voulez masquer certaines classes après l'inclusion du fichier

```
@startuml
```

```
class Foo1
class Foo2
```



```

Foo2 *-- Foo1

hide Foo2

@enduml

```



3.16 Supprimer des classes

Vous pouvez également utiliser les commandes `remove` pour supprimer des classes.

Cela peut être utile si vous définissez un grand fichier `includ`, et si vous voulez supprimer certaines classes après l'inclusion du fichier

```

@startuml

class Foo1
class Foo2

Foo2 *-- Foo1

remove Foo2

@enduml

```



3.17 Hide, Remove or Restore tagged element or wildcard

You can put `$tags` (using `$`) on elements, then remove, hide or restore components either individually or by tags.

By default, all components are displayed:

```

@startuml
class C1 $tag13
enum E1
interface I1 $tag13
C1 -- I1
@enduml

```

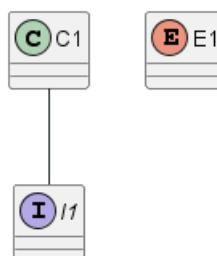

But you can:

- hide \$tag13 components:

```
@startuml
class C1 $tag13
enum E1
interface I1 $tag13
C1 -- I1

hide $tag13
@enduml
```



- or remove \$tag13 components:

```
@startuml
class C1 $tag13
enum E1
interface I1 $tag13
C1 -- I1

remove $tag13
@enduml
```



- or remove \$tag13 and restore \$tag1 components:

```
@startuml
class C1 $tag13 $tag1
enum E1
interface I1 $tag13
C1 -- I1

remove $tag13
restore $tag1
@enduml
```



- or remove * and restore \$tag1 components:

```
@startuml
class C1 $tag13 $tag1
enum E1
interface I1 $tag13
C1 -- I1

remove *
restore $tag1
```



```
@enduml
```

3.18 Masquer ou supprimer une classe non liée

Par défaut, toutes les classes sont affichées

```
@startuml
class C1
class C2
class C3
C1 -- C2
@enduml
```

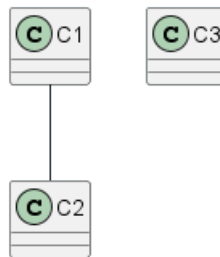

Mais vous pouvez :

- `hide @unlinked classes`

```
@startuml
class C1
class C2
class C3
C1 -- C2

hide @unlinked
@enduml
```



- ou `remove @unlinked classes`

```
@startuml
class C1
class C2
class C3
C1 -- C2

remove @unlinked
@enduml
```





[Adapté de QA-11052]

3.19 Utilisation de la généricité

Vous pouvez aussi utiliser les signes inférieur < et supérieur > pour définir l'utilisation de la généricité dans une classe.

```
@startuml
class Foo<? extends Element> {
    int size()
}
Foo *- Element
@enduml
```

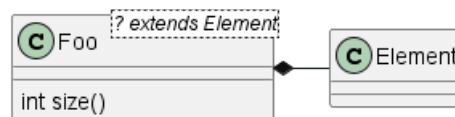

On peut désactiver ce comportement avec la commande `skinparam genericDisplay old`.

3.20 Caractère spécial

Normalement, un caractère (C, I, E ou A) est utilisé pour les classes, les interfaces ou les énum.

Vous pouvez aussi utiliser le caractère de votre choix, en définissant le stéréotype et en ajoutant une couleur, comme par exemple :

```
@startuml
class System << (S,#FF7700) Singleton >>
class Date << (D,orchid) >>
@enduml
```

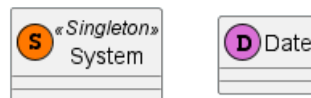

3.21 Packages

Vous pouvez définir un package en utilisant le mot-clé `package`, et optionnellement déclarer une couleur de fond pour votre package (en utilisant un code couleur HTML ou son nom).

Notez que les définitions de packages peuvent être imbriquées.

```
@startuml
package "Classic Collections" #DDDDDD {
    Object <|-- ArrayList
}
```



```

package net.sourceforge.plantuml {
    Object <|-- Demo1
    Demo1 *- Demo2
}

@enduml

```

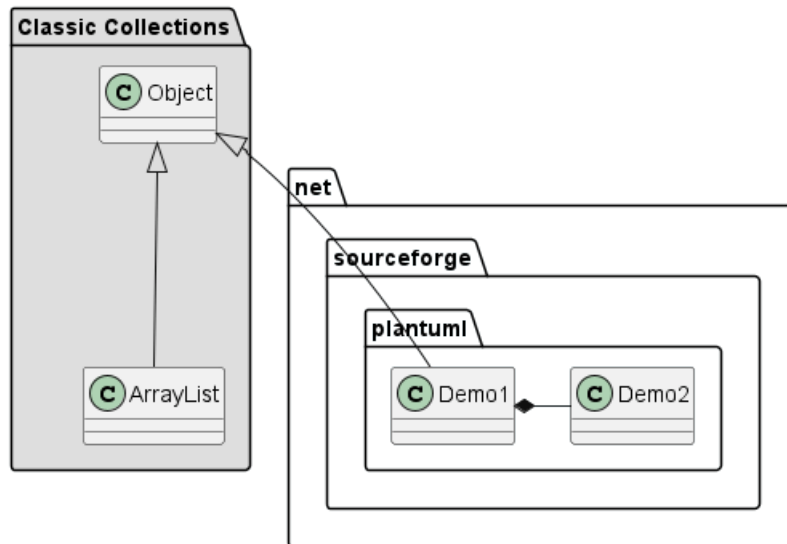

3.22 Modèle de paquet

Il y a différents styles de paquets disponibles.

Vous pouvez les spécifier chacun par un réglage par défaut avec la commande : `skinparam packageStyle`, ou par l'utilisation d'un stéréotype sur le paquet:

```

@startuml
scale 750 width
package foo1 <<Node>> {
    class Class1
}

package foo2 <<Rectangle>> {
    class Class2
}

package foo3 <<Folder>> {
    class Class3
}

package foo4 <<Frame>> {
    class Class4
}

package foo5 <<Cloud>> {
    class Class5
}

package foo6 <<Database>> {
    class Class6
}

@enduml

```





Vous pouvez aussi définir les liens entre les paquets, comme dans l'exemple suivant :

```
@startuml
skinparam packageStyle rectangle

package foo1.foo2 {
}

package foo1.foo2.foo3 {
    class Object
}

foo1.foo2 +-- foo1.foo2.foo3

@enduml
```

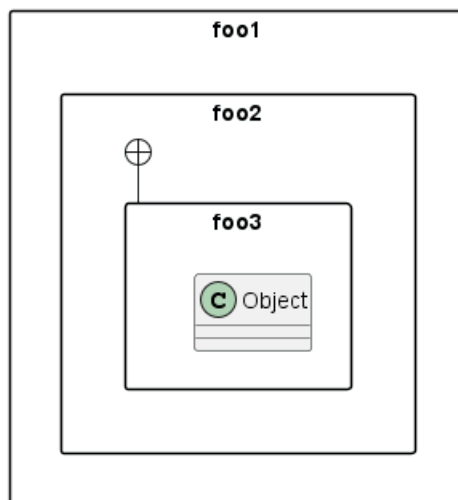

3.23 Les espaces de nommage

Avec les packages, le nom de la classe est l'identifiant unique de la classe. Cela signifie qu'on ne peut pas avoir deux classes avec le même nom dans deux packages différents. Pour ce faire, vous devez utiliser des espace de nommage (*namespace*) à la place des packages.

Vous pouvez faire référence à des classes d'autres espace de nommage en les nommant complètement. Les classes de l'espace de nommage par défaut (racine) sont nommées en commençant par un point.

Il n'est pas obligatoire de créer les espaces de nom. Une classe avec son nom complet sera automatiquement ajoutée au bon espace de nommage.

```
@startuml
class BaseClass

namespace net.dummy #DDDDDD {
    .BaseClass <|-- Person
    Meeting o-- Person
}
```



```

    .BaseClass <|- Meeting
  }

namespace net.foo {
  net.dummy.Person <|- Person
  .BaseClass <|-- Person

  net.dummy.Meeting o-- Person
}

BaseClass <|-- net.unused.Person

@enduml

```

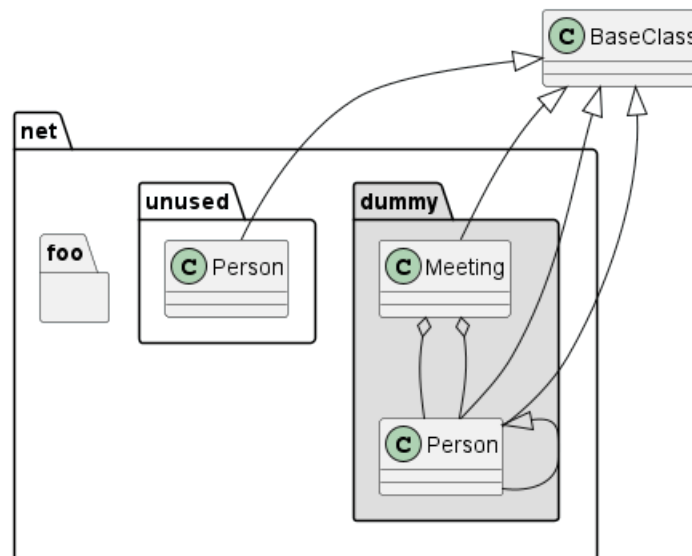

There won't be any difference between namespaces and packages anymore: both keywords are now synonymous.

3.24 Creation automatique d'espace de nommage

Vous pouvez définir une autre séparateur (autre que le point) en utilisant la commande : `set namespaceSeparator ???`.

```

@startuml

set namespaceSeparator ::
class X1::X2::foo {
  some info
}

@enduml

```

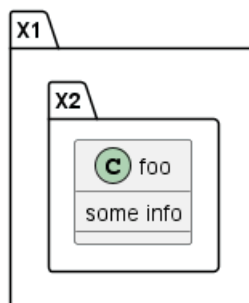

Vous pouvez désactiver la création automatique de package en utilisant la commande `set namespaceSeparator none`.

```
@startuml
set namespaceSeparator none
class X1.X2.foo {
    some info
}
@enduml
```

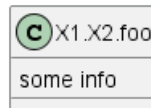

3.25 Interface boucle

Vous pouvez aussi rajouter des interfaces sur les classes avec la syntaxe suivante:

- `bar ()- foo`
- `bar ()-- foo`
- `foo -() bar`

```
@startuml
class foo
bar ()- foo
@enduml
```



3.26 Changer la direction

Par défaut, les liens entre les classe ont deux tirets -- et sont orientés verticalement. Il est possible d'utiliser une ligne horizontale en mettant un simple tiret (Ou un point) comme ceci:

```
@startuml
Room o- Student
Room *-- Chair
@enduml
```

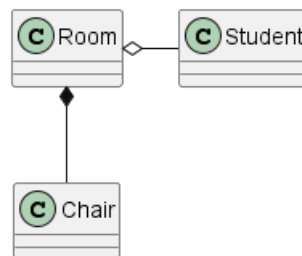

Vous pouvez aussi changer le sens en renversant le lien :

```
@startuml
Student -o Room
Chair --* Room
@enduml
```

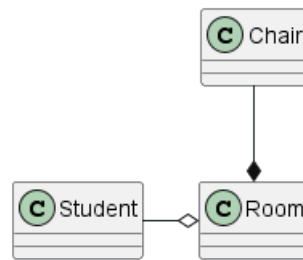

Il est aussi possible de changer la direction d'une flèche en ajoutant les mots clés `left`, `right`, `up` ou `down` à l'intérieur de la flèche:

```

@startuml
foo -left-> dummyLeft
foo -right-> dummyRight
foo -up-> dummyUp
foo -down-> dummyDown
@enduml
  
```

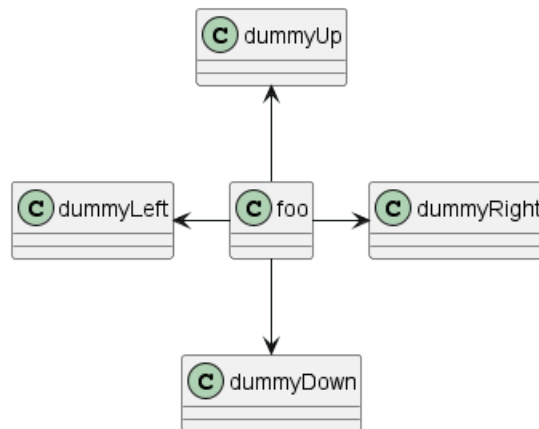

Il est possible de raccourcir la flèche en n'utilisant que la première lettre de la direction (par exemple, `-d-` au lieu de `-down-`) ou les deux premières lettres (`-do-`)

Attention à ne pas abuser de cette fonctionnalité : *GraphViz* donne généralement de bons résultats sans trop de raffistolages.

Et avec le paramètre `left to right direction`:

```

@startuml
left to right direction
foo -left-> dummyLeft
foo -right-> dummyRight
foo -up-> dummyUp
foo -down-> dummyDown
@enduml
  
```

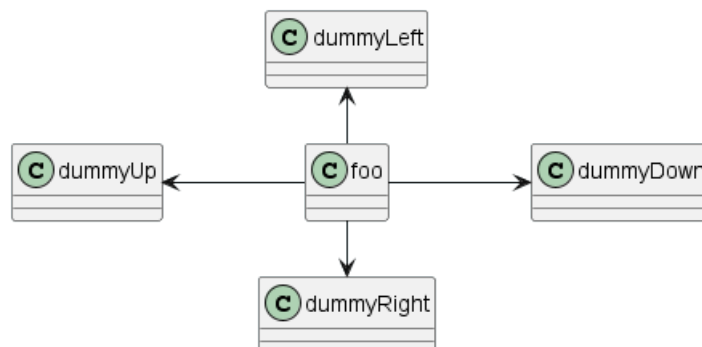

3.27 Classes d'association

Vous pouvez définir une *classe d'association* après qu'une relation ait été définie entre deux classes, comme dans l'exemple suivant:

```
@startuml
class Student {
    Name
}
Student "0..*" - "1..*" Course
(Student, Course) .. Enrollment

class Enrollment {
    drop()
    cancel()
}
@enduml
```

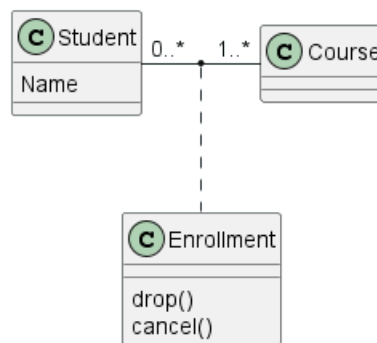

Vous pouvez la définir dans une autre direction :

```
@startuml
class Student {
    Name
}
Student "0..*" -- "1..*" Course
(Student, Course) . Enrollment

class Enrollment {
    drop()
    cancel()
}
@enduml
```

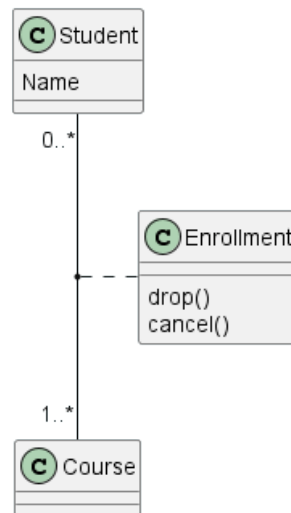

3.28 Association sur la même classe

```

@startuml
class Station {
    +name: string
}

class StationCrossing {
    +cost: TimeInterval
}

<> diamond

StationCrossing . diamond
diamond - "from 0..*" Station
diamond - "to 0..*" Station
@enduml
  
```

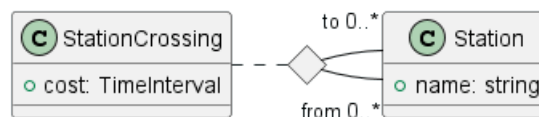

[Réf. Incubation : Associations]

3.29 Personnalisation

La commande `skinparam` permet de changer la couleur et les polices de caractères.

Vous pouvez utiliser cette commande :

- Dans le diagramme, comme toutes les autres commandes,
- Dans un fichier inclus,
- Dans un fichier de configuration précisé par la ligne de commande ou la tâche ANT.

```

@startuml
skinparam class {
  BackgroundColor PaleGreen
  ArrowColor SeaGreen
  BorderColor SpringGreen
}
  
```



```
skinparam stereotypeCBackgroundColor YellowGreen
```

```
Class01 "1" *-- "many" Class02 : contains
```

```
Class03 o-- Class04 : aggregation
```

```
@enduml
```

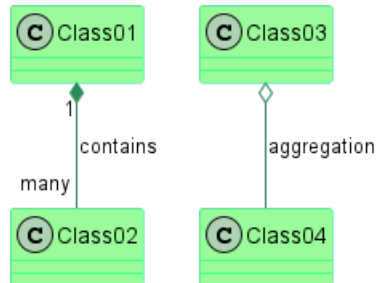

3.30 Stéréotypes Personnalisés

Vous pouvez définir des couleurs et des fontes de caractères spécifiques pour les classes stéréotypées.

```
@startuml
```

```
skinparam class {
  BackgroundColor PaleGreen
  ArrowColor SeaGreen
  BorderColor SpringGreen
  BackgroundColor<<Foo>> Wheat
  BorderColor<<Foo>> Tomato
}
skinparam stereotypeCBackgroundColor YellowGreen
skinparam stereotypeCBackgroundColor<< Foo >> DimGray
```

```
Class01 <<Foo>>
```

```
Class03 <<Foo>>
```

```
Class01 "1" *-- "many" Class02 : contains
```

```
Class03 o-- Class04 : aggregation
```

```
@enduml
```

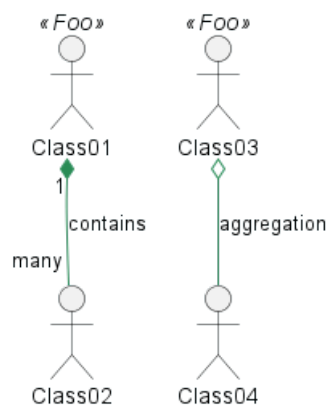

3.31 Dégradé de couleurs

Vous pouvez déclarer des couleurs individuelles pour les classes, les notes, etc. en utilisant la notation #.



Vous pouvez utiliser des noms de couleurs standard ou des codes RVB dans diverses notations, voir Couleurs.

Vous pouvez également utiliser le dégradé de couleurs pour les couleurs de fond, avec la syntaxe suivante : deux noms de couleurs séparés soit par :

- | ,
- / ,
- \ , ou
- -

selon la direction du gradient.

Par exemple

```
@startuml
skinparam backgroundColor AntiqueWhite/Gold
skinparam classBackgroundColor Wheat|CornflowerBlue

class Foo #red-green
note left of Foo #blue\9932CC
    this is my
    note on this class
end note

package example #GreenYellow/LightGoldenRodYellow {
    class Dummy
}

@enduml
```



3.32 Aide pour la mise en page

Sometimes, the default layout is not perfect...

You can use `together` keyword to group some classes together : the layout engine will try to group them (as if they were in the same package).

You can also use `hidden` links to force the layout.

```
@startuml
class Bar1
class Bar2
together {
    class Together1
    class Together2
    class Together3
}
Together1 - Together2
Together2 - Together3
Together2 -[hidden]--> Bar1
Bar1 -[hidden]> Bar2
```



```
@enduml
```

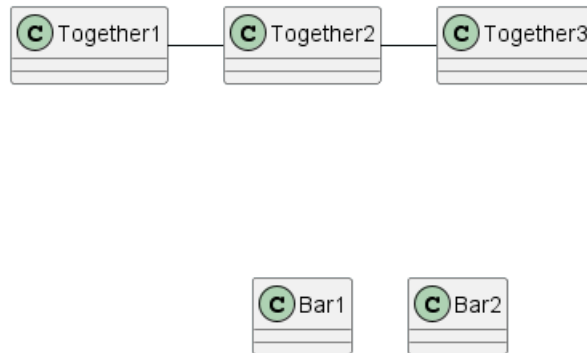

3.33 Découper les grands diagrammes

Parfois, vous obtiendrez des images de taille importante.

Vous pouvez utiliser la commande `page (hpages)x(vpages)` pour découper l'image en plusieurs fichiers: `hpages` est le nombre de pages horizontales et `vpages` indique le nombre de pages verticales.

Vous pouvez aussi utiliser des paramètres spécifiques pour rajouter des bords sur les pages découpées (voir l'exemple).

```

@startuml
' Split into 4 pages
page 2x2
skinparam pageMargin 10
skinparam pageExternalColor gray
skinparam pageBorderColor black

class BaseClass

namespace net.dummy #DDDDDD {
  .BaseClass <|-- Person
  Meeting o-- Person

  .BaseClass <|-- Meeting
}

namespace net.foo {
  net.dummy.Person <|-- Person
  .BaseClass <|-- Person

  net.dummy.Meeting o-- Person
}

BaseClass <|-- net.unused.Person
@enduml

```

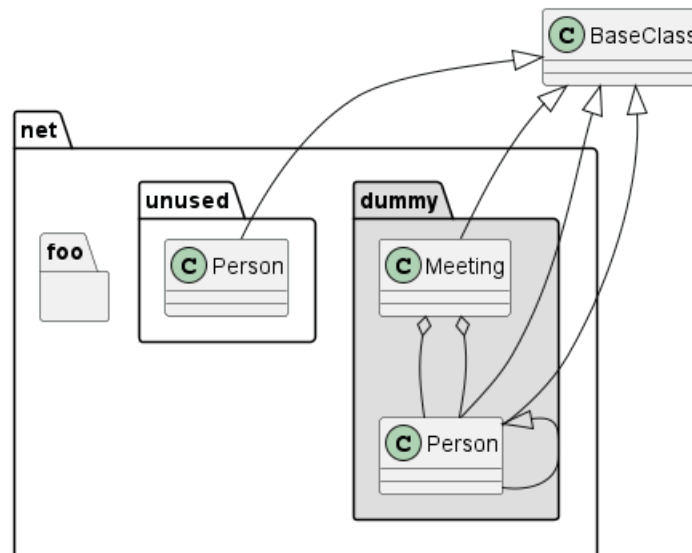

3.34 Extension et implementation [extends, implements]

Il est aussi possible d'utiliser directement les mots clés `extends` and `implements`.

```
@startuml
class ArrayList implements List
class ArrayList extends AbstractList
@enduml
```

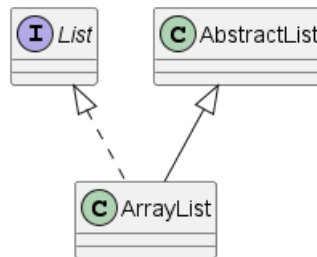

3.35 Relations entre crochets (liens ou flèches) style

3.35.1 Style de ligne

Il est également possible d'avoir explicitement des relations, des liens ou des flèches `bold`, `dashed`, `dotted`, `hidden` ou `plain`:

- sans étiquette

```
@startuml
title Bracketed line style without label
class foo
class bar
bar1 : [bold]
bar2 : [dashed]
bar3 : [dotted]
bar4 : [hidden]
bar5 : [plain]

foo --> bar
foo -[bold]-> bar1
foo -[dashed]-> bar2
```



```

foo -[dotted]-> bar3
foo -[hidden]-> bar4
foo -[plain]-> bar5
@enduml

```

Bracketed line style without label

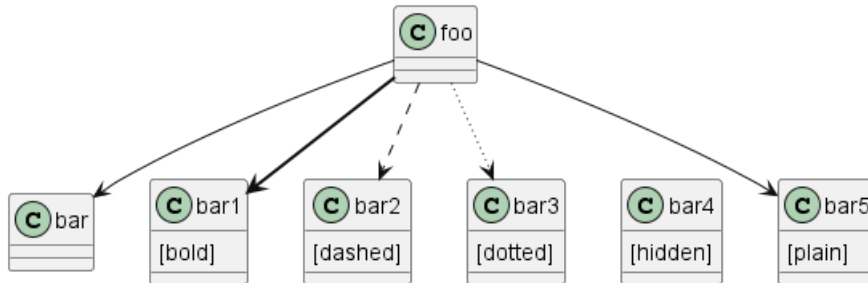

- avec étiquette

```

@startuml
title Bracketed line style with label
class foo
class bar
bar1 : [bold]
bar2 : [dashed]
bar3 : [dotted]
bar4 : [hidden]
bar5 : [plain]

foo --> bar      :
foo -[bold]-> bar1 : [bold]
foo -[dashed]-> bar2 : [dashed]
foo -[dotted]-> bar3 : [dotted]
foo -[hidden]-> bar4 : [hidden]
foo -[plain]-> bar5 : [plain]
@enduml

```

Bracketed line style with label

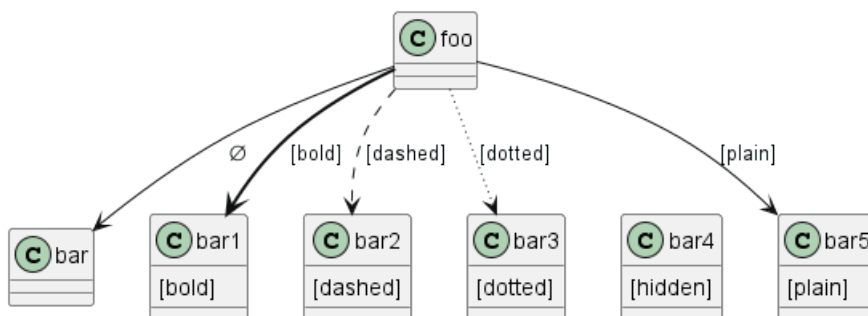

[Adapté de QA-4181]

3.35.2 Couleur de ligne

```

@startuml
title Bracketed line color
class foo
class bar
bar1 : [#red]

```



```

bar2 : [#green]
bar3 : [#blue]

foo --> bar
foo -[#red]-> bar1 : [#red]
foo -[#green]-> bar2 : [#green]
foo -[#blue]-> bar3 : [#blue]
'foo -[#blue;#yellow;#green]-> bar4
@enduml

```

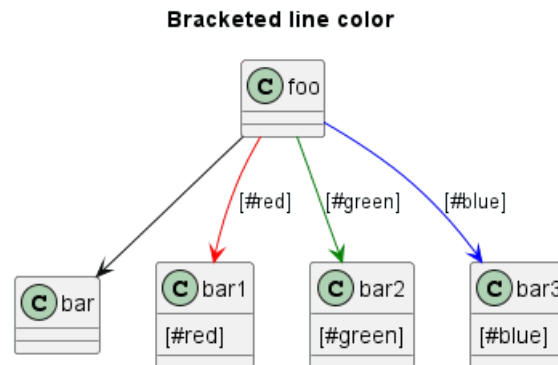

3.35.3 Épaisseur de ligne

```

@startuml
title Bracketed line thickness
class foo
class bar
bar1 : [thickness=1]
bar2 : [thickness=2]
bar3 : [thickness=4]
bar4 : [thickness=8]
bar5 : [thickness=16]

foo --> bar :
foo -[thickness=1]-> bar1 : [1]
foo -[thickness=2]-> bar2 : [2]
foo -[thickness=4]-> bar3 : [4]
foo -[thickness=8]-> bar4 : [8]
foo -[thickness=16]-> bar5 : [16]

@enduml

```

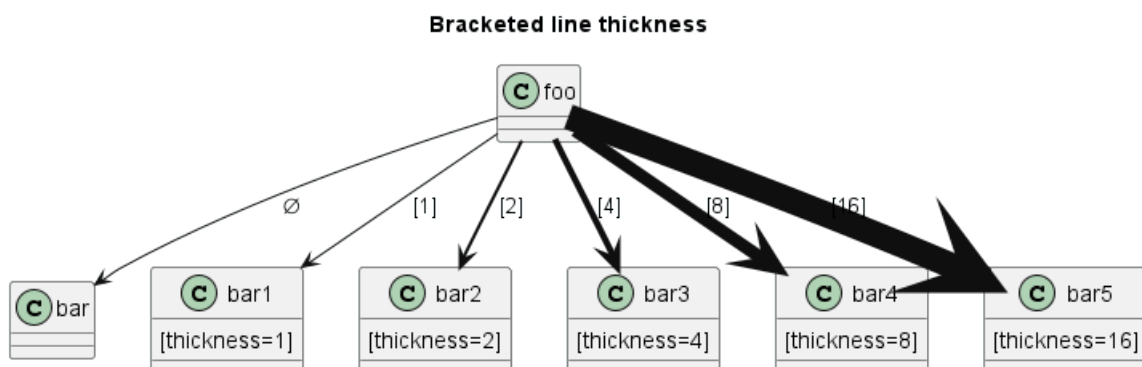

[Réf. QA-4949]



3.35.4 Mélange

```

@startuml
title Bracketed line style mix
class foo
class bar
bar1 : [#red,thickness=1]
bar2 : [#red,dashed,thickness=2]
bar3 : [#green,dashed,thickness=4]
bar4 : [#blue,dotted,thickness=8]
bar5 : [#blue,plain,thickness=16]

foo --> bar
foo -[#red,thickness=1]-> bar1 : [#red,1]
foo -[#red,dashed,thickness=2]-> bar2 : [#red,dashed,2]
foo -[#green,dashed,thickness=4]-> bar3 : [#green,dashed,4]
foo -[#blue,dotted,thickness=8]-> bar4 : [blue,dotted,8]
foo -[#blue,plain,thickness=16]-> bar5 : [blue,plain,16]
@enduml

```

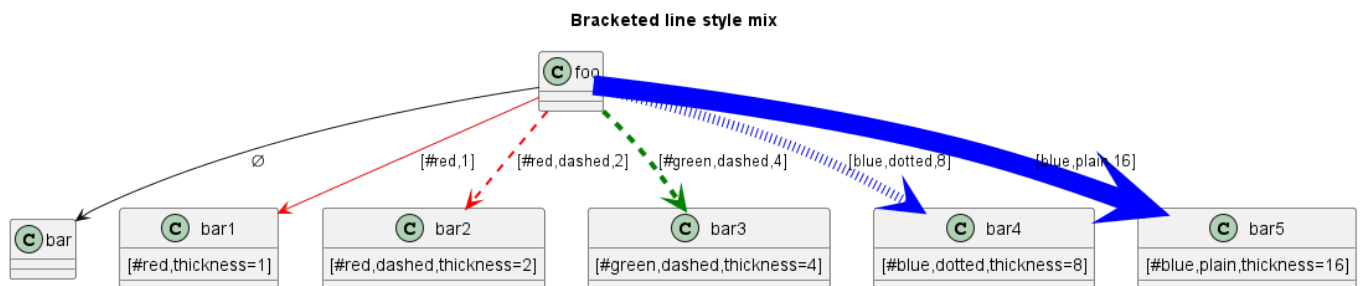

3.36 Modifier la couleur et le style d'une relation (lien ou flèche) (style en ligne)

Vous pouvez modifier la couleur ou le style d'une relation ou d'une flèche individuelle en utilisant la notation suivante en ligne

- `#color;line.[bold|dashed|dotted];text:color`

```

@startuml
class foo
foo --> bar : normal
foo --> bar1 #line:red;line.bold;text:red : red bold
foo --> bar2 #green;line.dashed;text:green : green dashed
foo --> bar3 #blue;line.dotted;text:blue : blue dotted
@enduml

```

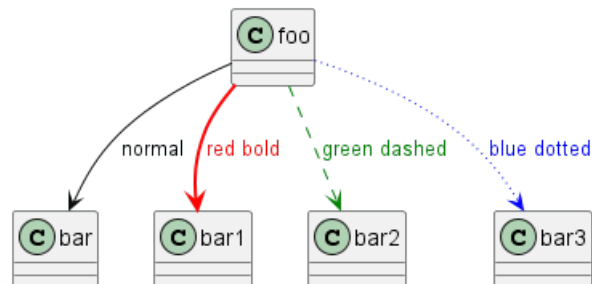

[Voir une fonctionnalité similaire sur le déploiement]



3.37 Modifier la couleur et le style d'une classe (style en ligne)

Vous pouvez modifier la couleur ou le style d'une classe individuelle en utilisant les deux notations suivantes

- `#color ##[style]color`

Avec la couleur de fond d'abord (`#color`), puis le style de ligne et la couleur de ligne (`##[style]color`)

```
@startuml
abstract    abstract
annotation  annotation #pink ##[bold]red
class       class      #palegreen ##[dashed]green
interface   interface  #aliceblue ##[dotted]blue
@enduml
```

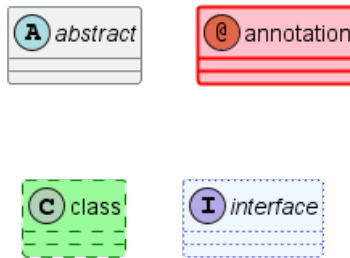

[Réf. QA-1487]

- `#[color|back:color];header:color;line:color;line.[bold|dashed|dotted];text:color`

```
@startuml
abstract    abstract
annotation  annotation #pink;line:red;line.bold;text:red
class       class      #palegreen;line:green;line.dashed;text:green
interface   interface  #aliceblue;line:blue;line.dotted;text:blue
@enduml
```

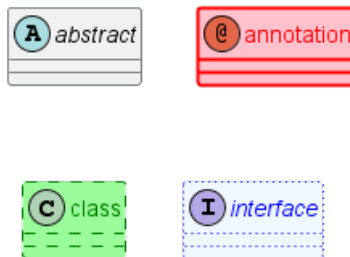

Premier exemple original

```
@startuml
class bar #line:green;back:lightblue
class bar2 #lightblue;line:green

class Foo1 #back:red;line:00FFFF
class FooDashed #line.dashed:blue
class FooDotted #line.dotted:blue
class FooBold #line.bold
class Demo1 #back:lightgreen|yellow;header:blue/red
@enduml
```



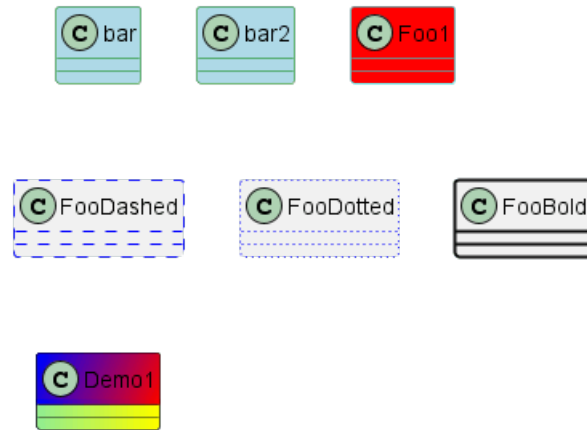

[Réf. QA-3770]

3.38 Flèches de/vers les membres de la classe

```
@startuml
class Foo {
+ field1
+ field2
}

class Bar {
+ field3
+ field4
}

Foo::field1 --> Bar::field3 : foo
Foo::field2 --> Bar::field4 : bar
@enduml
```

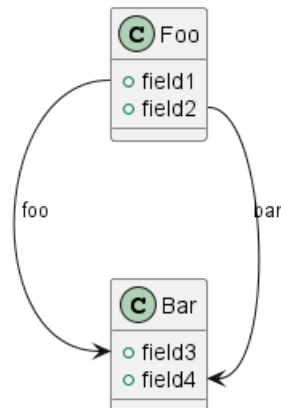

Ref. QA-3636]

```
@startuml
left to right direction

class User {
id : INTEGER
..
other_id : INTEGER
}

class Email {
```



```

id : INTEGER
..
user_id : INTEGER
address : INTEGER
}

User::id *-- Email::user_id
@enduml

```

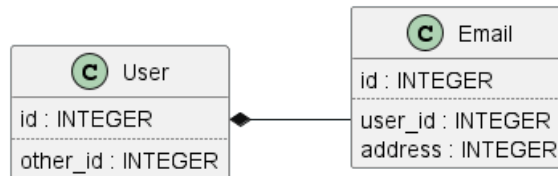

[Réf. QA-5261]

3.39 Regroupement de flèche d'héritage

Vous pouvez fusionner toutes les têtes de flèche à l'aide de la fonction `skinparam groupInheritance`, avec un seuil comme paramètre.

3.39.1 GroupInheritance 1 (pas de regroupement)

```

@startuml
skinparam groupInheritance 1

A1 <|-- B1

A2 <|-- B2
A2 <|-- C2

A3 <|-- B3
A3 <|-- C3
A3 <|-- D3

A4 <|-- B4
A4 <|-- C4
A4 <|-- D4
A4 <|-- E4
@enduml

```

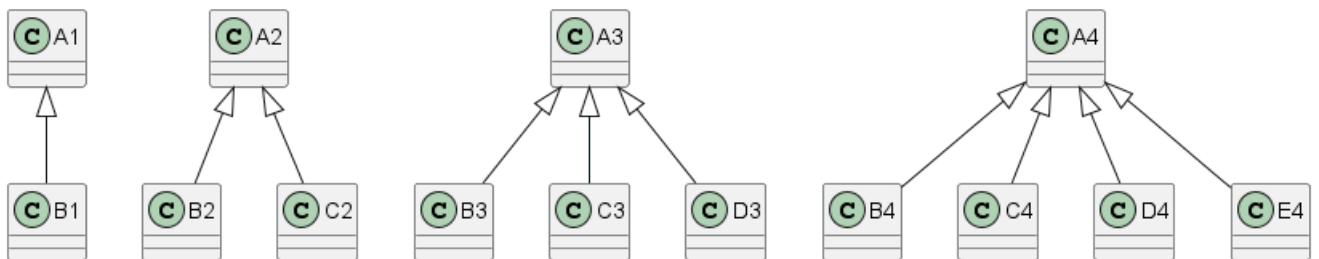

3.39.2 GroupInheritance 2 (regroupement à partir de 2)

```

@startuml
skinparam groupInheritance 2

A1 <|-- B1

```



```
A2 <|-- B2
A2 <|-- C2
```

```
A3 <|-- B3
A3 <|-- C3
A3 <|-- D3
```

```
A4 <|-- B4
A4 <|-- C4
A4 <|-- D4
A4 <|-- E4
@enduml
```

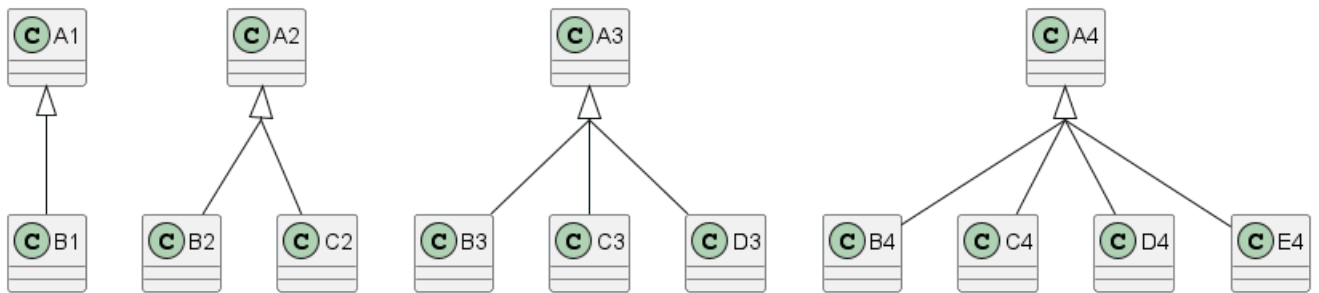

3.39.3 GroupInheritance 3 (regroupement uniquement à partir de 3)

```
@startuml
skinparam groupInheritance 3
```

```
A1 <|-- B1
```

```
A2 <|-- B2
A2 <|-- C2
```

```
A3 <|-- B3
A3 <|-- C3
A3 <|-- D3
```

```
A4 <|-- B4
A4 <|-- C4
A4 <|-- D4
A4 <|-- E4
@enduml
```

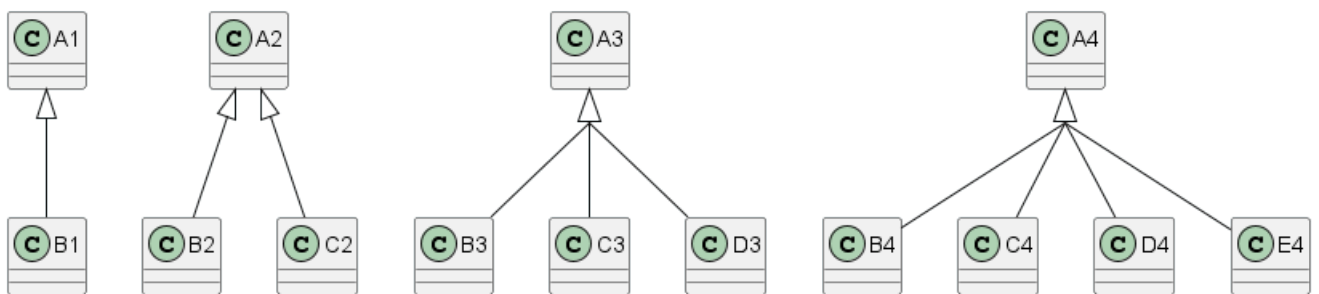

3.39.4 GroupInheritance 4 (regroupement uniquement à partir de 4)

```
@startuml
skinparam groupInheritance 4
```

```
A1 <|-- B1
```

```
A2 <|-- B2
```

```
A2 <|-- C2
```

```
A3 <|-- B3
```

```
A3 <|-- C3
```

```
A3 <|-- D3
```

```
A4 <|-- B4
```

```
A4 <|-- C4
```

```
A4 <|-- D4
```

```
A4 <|-- E4
```

```
@enduml
```

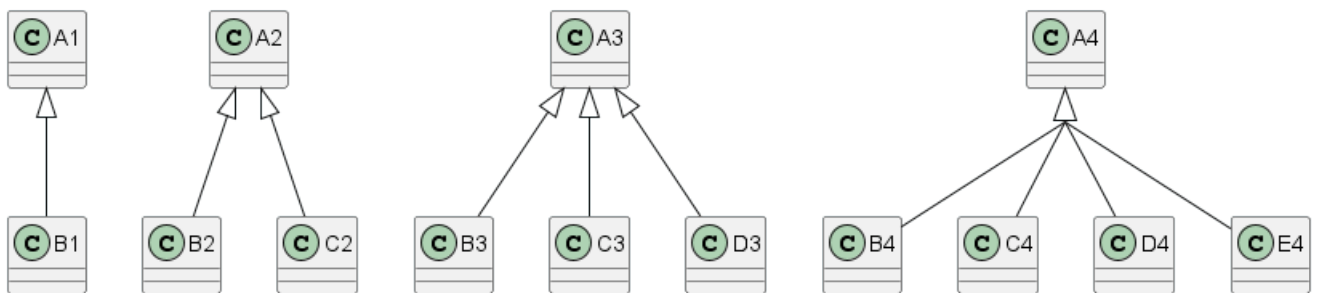

[Réf. QA-3193, et Défaut QA-13532]

3.40 Display JSON Data on Class or Object diagram

3.40.1 Simple example

```

@startuml
class Class
object Object
json JSON {
  "fruit": "Apple",
  "size": "Large",
  "color": ["Red", "Green"]
}
@enduml
  
```

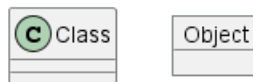

JSON	
fruit	Apple
size	Large
color	Red
	Green

[Ref. QA-15481]

For another example, see on JSON page.



3.41 Packages and Namespaces Enhancement

[From V1.2023.2+, and V1.2023.5]

```
@startuml
class A.B.C.D.Z {
}
@enduml
```

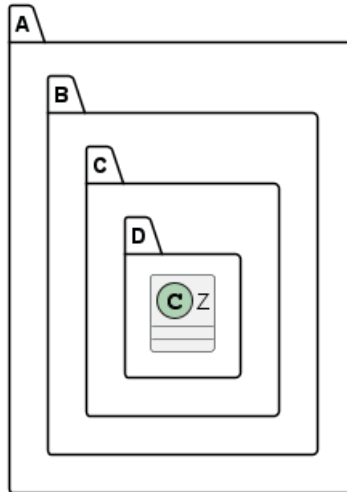

```
@startuml
set separator none
class A.B.C.D.Z {
}
@enduml
```

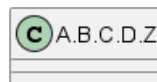

```
@startuml
!pragma useIntermediatePackages false
class A.B.C.D.Z {
}
@enduml
```

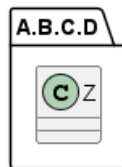

```
@startuml
set separator none
package A.B.C.D {
  class Z {
  }
}
@enduml
```

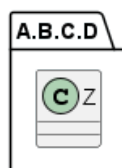

[Ref. GH-1352]



4 Diagramme d'objets

PlantUML offers a simple and intuitive way to create object diagrams using plain text. Its user-friendly syntax allows for quick diagram creation without the need for complex GUI tools. Moreover, the PlantUML forum provides a platform for users to discuss, share, and seek assistance, fostering a collaborative community. By choosing PlantUML, users benefit from both the efficiency of markdown-based diagramming and the support of an active community.

4.1 Définition des objets

Les instances d'objets sont définies avec le mot clé `object`.

```
@startuml
object firstObject
object "My Second Object" as o2
@enduml
```

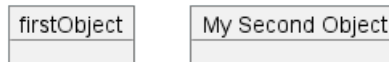

4.2 Relations entre les objets

Les relations entre objets sont définies à l'aide des symboles suivants :

Type	Symbol	Image
Extension	< --	
Composition	*--	
Aggregation	o--	

Il est possible de remplacer `--` par `..` pour avoir des pointillés.

Grâce à ces règles, on peut avoir les dessins suivants:

Il est possible d'ajouter une étiquette sur la relation, en utilisant `:` suivi par le texte de l'étiquette.

Pour les cardinalités, vous pouvez utiliser les doubles quotes `"` sur chaque côté de la relation.

```
@startuml
object Object01
object Object02
object Object03
object Object04
object Object05
object Object06
object Object07
object Object08

Object01 <|-- Object02
Object03 *-- Object04
Object05 o-- "4" Object06
Object07 .. Object08 : some labels
@enduml
```

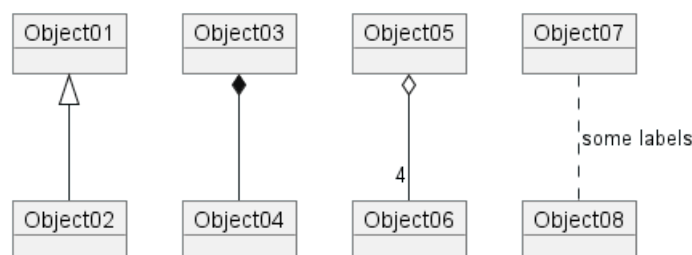

4.3 Association d'objects

```
@startuml
object o1
object o2
diamond dia
object o3

o1 --> dia
o2 --> dia
dia --> o3
@enduml
```



4.4 Ajout de champs

Pour déclarer un champ, vous pouvez utiliser le symbole : suivi par le nom du champs.

```
@startuml
object user

user : name = "Dummy"
user : id = 123

@enduml
```

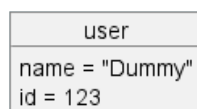

It is also possible to ground between brackets {} all fields.

```
@startuml
object user {
  name = "Dummy"
  id = 123
}

@enduml
```

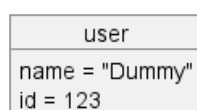

4.5 Caractéristiques communes avec les diagrammes de classes

- Visibilité
- Ajout de notes
- Utilisation de packages
- Personnalisation de l'affichage

4.6 Table de correspondance ou tableau associatif

Vous pouvez définir une table de correspondance ou un tableau associatif, avec le mot clé `map` et le séparateur `=>`

```
@startuml
map CapitalCity {
  UK => London
  USA => Washington
  Germany => Berlin
}
@enduml
```

CapitalCity	
UK	London
USA	Washington
Germany	Berlin

```
@startuml
map "Map **Contry => CapitalCity**" as CC {
  UK => London
  USA => Washington
  Germany => Berlin
}
@enduml
```

Map Contry => CapitalCity	
UK	London
USA	Washington
Germany	Berlin

```
@startuml
map "map: Map<Integer, String>" as users {
  1 => Alice
  2 => Bob
  3 => Charlie
}
@enduml
```

map: Map<Integer, String>	
1	Alice
2	Bob
3	Charlie

Et ajouter un lien avec un objet

```
@startuml
object London

map CapitalCity {
```



```

UK *-> London
USA => Washington
Germany => Berlin
}
@enduml

```

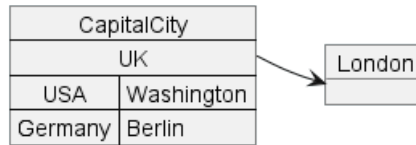

```

@startuml
object London
object Washington
object Berlin
object NewYork

map CapitalCity {
  UK *-> London
  USA *--> Washington
  Germany *---> Berlin
}

NewYork --> CapitalCity::USA
@enduml

```

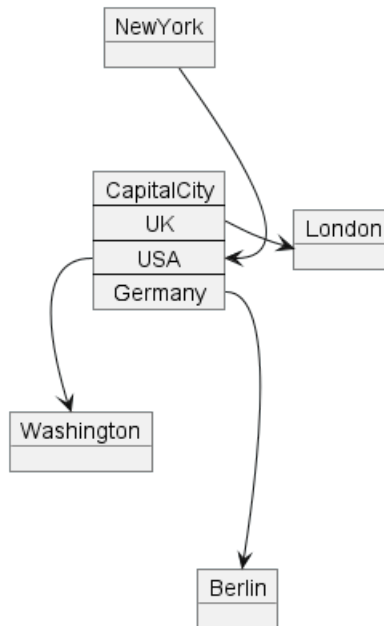

[Réf. n° 307]

4.7 Program (or project) evaluation and review technique (PERT) with `map`

You can use `map` table in order to make Program (or project) evaluation and review technique (PERT) diagram.

```

@startuml PERT
left to right direction
' Horizontal lines: -->, <--, <-->
' Vertical lines: ->, <-, <->
title PERT: Project Name

```



```

map Kick.Off {
}
map task.1 {
  Start => End
}
map task.2 {
  Start => End
}
map task.3 {
  Start => End
}
map task.4 {
  Start => End
}
map task.5 {
  Start => End
}
Kick.Off --> task.1 : Label 1
Kick.Off --> task.2 : Label 2
Kick.Off --> task.3 : Label 3
task.1 --> task.4
task.2 --> task.4
task.3 --> task.4
task.4 --> task.5 : Label 4
@enduml

```

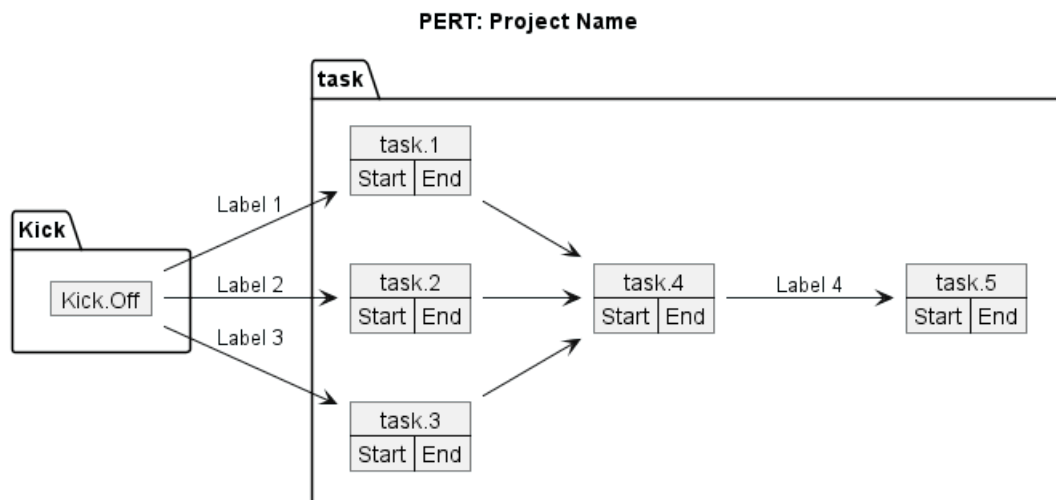

[Ref. QA-12337]

4.8 Display JSON Data on Class or Object diagram

4.8.1 Simple example

```

@startuml
class Class
object Object
json JSON {
  "fruit": "Apple",
  "size": "Large",
  "color": ["Red", "Green"]
}
@enduml

```



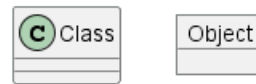

JSON	
fruit	Apple
size	Large
color	Red
	Green

[Ref. QA-15481]

For another example, see on JSON page.

5 Diagrammes d'activité (ancienne syntaxe)

Il s'agit de l'ancienne syntaxe du diagramme d'activités, pour voir la nouvelle version actuelle, voir: Diagrammes d'activité (nouvelle syntaxe).

5.1 Action simple

Vous pouvez utiliser (*) pour le point de départ et le point d'arrivée de le diagramme d'activité.

Dans certaines occasions, vous pouvez utiliser (*top) pour forcer le point de départ à être en haut du diagramme.

Utilisez --> pour les flèches

```
@startuml
(*) --> "First Action"
"First Action" --> (*)
@enduml
```

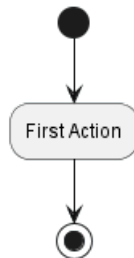

5.2 Texte sur les flèches

Par défaut, une flèche commence à partir de la dernière activité définie.

Vous pouvez rajouter un libellé sur une flèche en mettant des crochets [et] juste après la définition de la flèche.

```
@startuml
(*) --> "First Action"
-->[You can put also labels] "Second Action"
--> (*)
@enduml
```

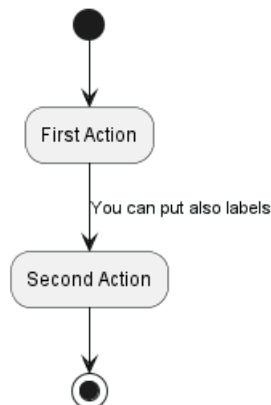

5.3 Changer la direction des flèches

Vous pouvez utiliser `->` pour les flèches horizontales. Il est aussi possible de forcer la direction d'une flèche en utilisant la syntaxe suivante :

- `-down->` (default arrow)
- `-right->` or `->`
- `-left->`
- `-up->`

```
@startuml
```

```
(*) -up-> "First Action"
-right-> "Second Action"
--> "Third Action"
-left-> (*)
```

```
@enduml
```

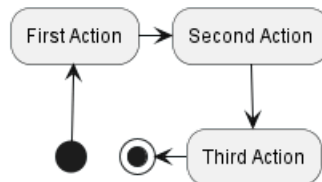

5.4 Branches

Vous pouvez utiliser le mot clé `if/then/else` pour définir une branche.

```
@startuml
```

```
(*) --> "Initialization"

if "Some Test" then
  -->[true] "Some Action"
  --> "Another Action"
  -right-> (*)
else
  ->[false] "Something else"
  -->[Ending process] (*)
endif
```

```
@enduml
```

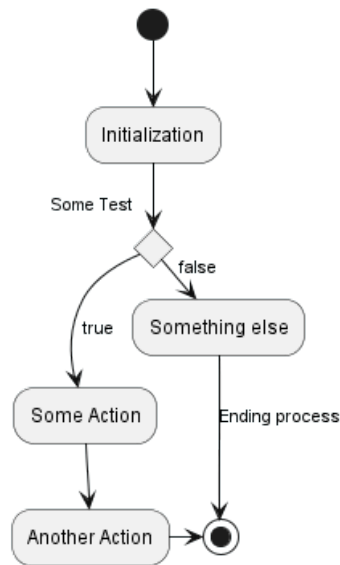
Malheureusement, vous devez parfois avoir à répéter la même activité dans le diagramme de texte.

```

@startuml
(*) --> "check input"
If "input is verbose" then
--> [Yes] "turn on verbosity"
--> "run command"
else
--> "run command"
Endif
-->(*)
@enduml
  
```

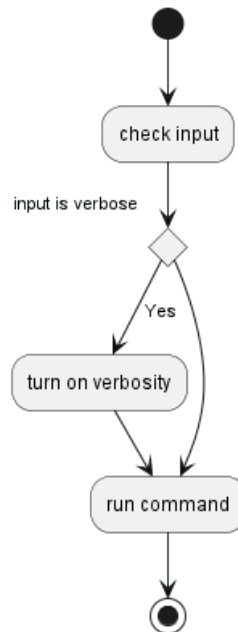

5.5 Encore des branches

Par défaut, une branche commence à la dernière activité définie, mais il est possible de passer outre et de définir un lien avec le mot clé `if`.

Il est aussi possible d'imbruquer les branches.

```

@startuml
  
```



```

(*) --> if "Some Test" then

-->[true] "activity 1"

if "" then
  -> "activity 3" as a3
else
  if "Other test" then
    -left-> "activity 5"
  else
    --> "activity 6"
  endif
endif

else

->[false] "activity 2"

endif

a3 --> if "last test" then
  --> "activity 7"
else
  -> "activity 8"
endif

@enduml

```

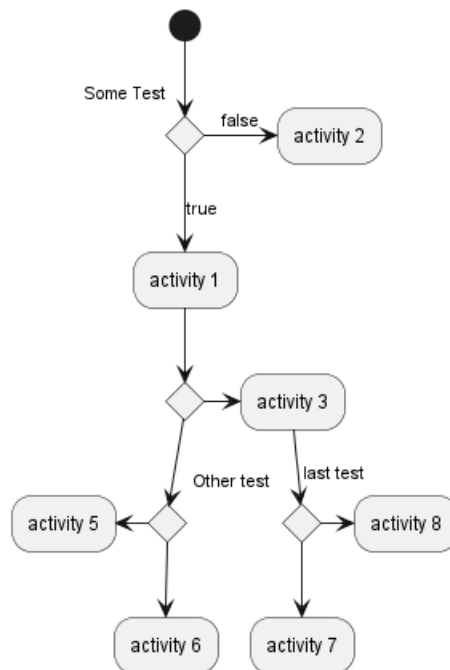

5.6 Synchronisation

Vous pouvez utiliser la syntaxe `=== code ===` pour afficher des barres de synchronisation.

```
@startuml
```

```

(*) --> ===B1===
--> "Parallel Activity 1"

```



```

--> ===B2===

===B1=== --> "Parallel Activity 2"
--> ===B2===

--> (*)

@enduml

```

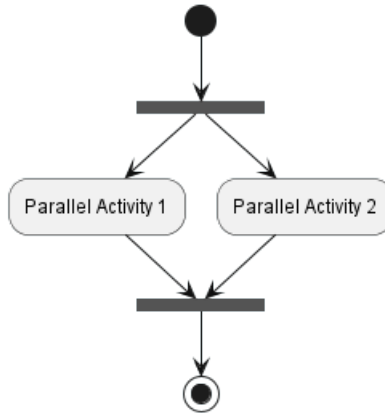

5.7 Description détaillée

Lorsque vous déclarez des activités, vous pouvez positionner sur plusieurs lignes le texte de description. Vous pouvez également ajouter dans la description. Il est également possible d'utiliser quelques tags HTML tels que :

Vous pouvez aussi donner un court code à l'activité avec le mot clé `as`. Ce code peut être utilisé plus tard dans le diagramme de description.

```

@startuml
(*) -left-> "this <size:20>activity</size>
is <b>very</b> <color:red>long2</color>
and defined on several lines
that contains many <i>text</i>" as A1

-up-> "Another activity\n on several lines"

A1 --> "Short activity <img:sourceforge.jpg>"
@enduml

```

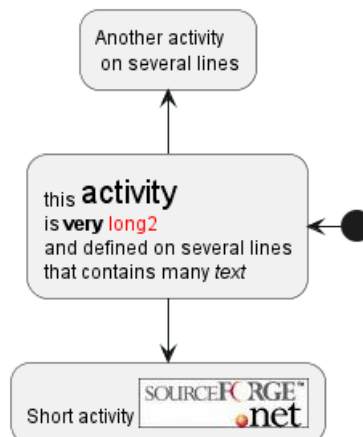

5.8 Notes

Vous pouvez rajouter des notes sur une activités en utilisant les commandes: `note left`, `note right`, `note top` ou `note bottom`, juste après la définition de l'activité concernée.

Si vous voulez mettre une note sur le démarrage du diagramme, définissez la note au tout début du diagramme.

Vous pouvez aussi avoir une note sur plusieurs lignes, en utilisant les mots clés `endnote`.

```
@startuml
```

```
(*) --> "Some Activity"
note right: This activity has to be defined
"Some Activity" --> (*)
note left
  This note is on
  several lines
end note
```

```
@enduml
```

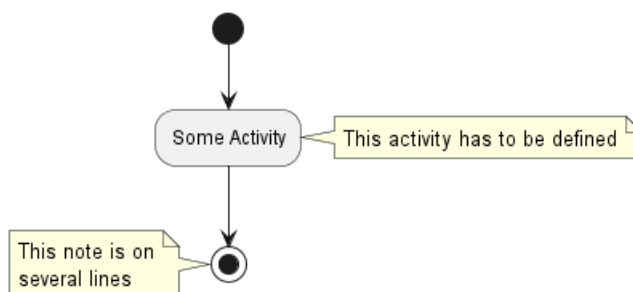

5.9 Partition

Vous pouvez définir une partition en utilisant le mot clé `partition`, et optionnellement déclarer un fond de couleur pour votre partition (En utilisant un code couleur html ou un nom)

Quand vous déclarez les activités, ils sont automatiquement mis dans la dernière partition utilisée.

Vous pouvez fermer la partition de définition en utilisant les crochets fermants `}`.

```
@startuml
```

```
partition Conductor {
  (*) --> "Climbs on Platform"
  --> === S1 ===
  --> Bows
}

partition Audience #LightSkyBlue {
  === S1 === --> Applauds
}

partition Conductor {
  Bows --> === S2 ===
  --> WavesArmes
  Applauds --> === S2 ===
}

partition Orchestra #CCCCEE {
  WavesArmes --> Introduction
  --> "Play music"
```



```

}
@enduml

```

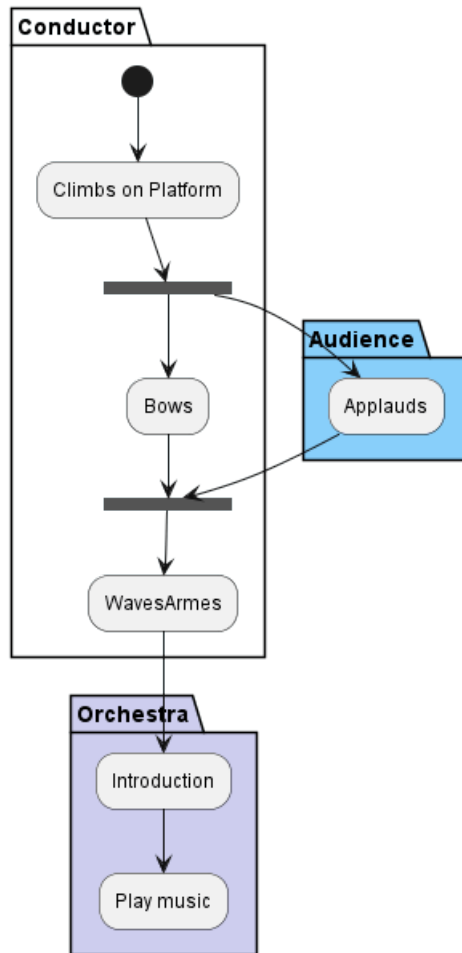

5.10 Paramètre de thème

Vous pouvez utiliser la commande `skinparam` pour changer la couleur et la police d'écriture pour dessiner.

Vous pouvez utiliser cette commande :

- Dans le diagramme de définition, comme n'importe quelle autre commande,
- Dans un fichier inclus,
- Dans un fichier de configuration, à l'aide de la ligne de commande ou la tâche ANT.

Vous pouvez spécifier une couleur et une police d'écriture dans les stéréotypes d'activités.

```

@startuml
skinparam backgroundColor #AAFFFF
skinparam activity {
  StartColor red
  BarColor SaddleBrown
  EndColor Silver
  BackgroundColor Peru
  BackgroundColor<< Begin >> Olive
  BorderColor Peru
  FontName Impact
}

```



```

(*) --> "Climbs on Platform" << Begin >>
--> === S1 ===
--> Bows
--> === S2 ===
--> WavesArmes
--> (*)

@enduml

```

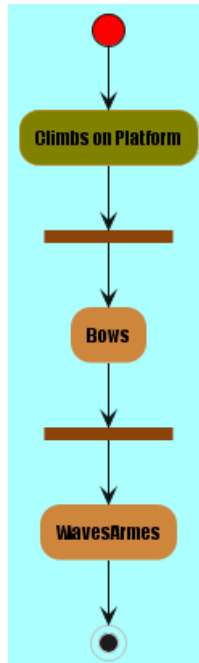

5.11 Octogone

Vous pouvez changer la forme des activités en octogone en utilisant la commande `skinparam activityShape octagon`.

```

@startuml
'Default is skinparam activityShape roundBox
skinparam activityShape octagon

```

```

(*) --> "First Activity"
"First Activity" --> (*)

```

```

@enduml

```

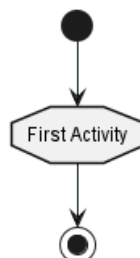

5.12 Exemple complet

```

@startuml
title Servlet Container

(*) --> "ClickServlet.handleRequest()"

```



```
--> "new Page"

if "Page.onSecurityCheck" then
  ->[true] "Page.onInit()"

  if "isForward?" then
    ->[no] "Process controls"

    if "continue processing?" then
      -->[yes] ===RENDERING===
    else
      -->[no] ===REDIRECT_CHECK===
    endif

  else
    -->[yes] ===RENDERING===
  endif

  if "is Post?" then
    -->[yes] "Page.onPost()"
    --> "Page.onRender()" as render
    --> ===REDIRECT_CHECK===
  else
    -->[no] "Page.onGet()"
    --> render
  endif

else
  -->[false] ===REDIRECT_CHECK===
endif

if "Do redirect?" then
  ->[yes] "redirect request"
  --> ==BEFORE_DESTROY==
else
  if "Do Forward?" then
    -left->[yes] "Forward request"
    --> ==BEFORE_DESTROY==
  else
    -right->[no] "Render page template"
    --> ==BEFORE_DESTROY==
  endif
endif

--> "Page.onDestroy()"
-->(*)

@enduml
```

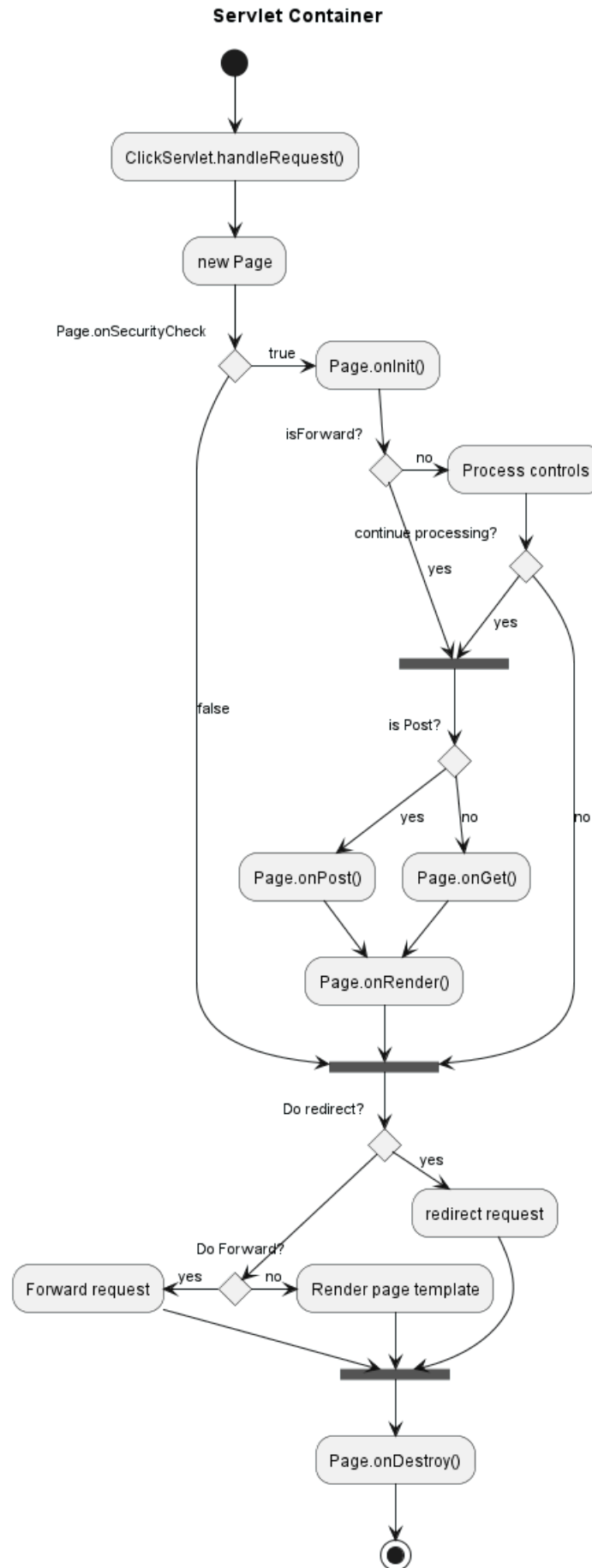

6 Diagramme d'activité (nouvelle syntaxe)

La syntaxe précédente utilisée pour les diagrammes d'activité présentait plusieurs limitations et problèmes de maintenabilité. Conscients de ces inconvénients, nous avons introduit une syntaxe et une implémentation entièrement remaniées qui sont non seulement conviviales mais aussi plus stables.

6.0.1 Avantages de la nouvelle syntaxe

- Aucune dépendance à l'égard de Graphviz : Tout comme pour les diagrammes de séquence, la nouvelle syntaxe élimine la nécessité d'installer Graphviz, ce qui simplifie le processus de configuration.
- Facilité de maintenance : La nature intuitive de la nouvelle syntaxe signifie qu'il est plus facile de gérer et de maintenir vos diagrammes.

6.0.2 Transition vers la nouvelle syntaxe

Bien que nous continuions à prendre en charge l'ancienne syntaxe pour maintenir la compatibilité, nous encourageons vivement les utilisateurs à migrer vers la nouvelle syntaxe pour tirer parti des fonctionnalités améliorées et des avantages qu'elle offre.

Faites le changement dès aujourd'hui et découvrez un processus de création de diagrammes plus rationalisé et plus efficace avec la nouvelle syntaxe de diagramme d'activité.

6.1 Action simple

L'étiquette des activités commence par `:` et se termine par `;`.

Le formatage du texte peut se faire en utilisant la syntaxe wiki créole.

Ils sont implicitement liés dans l'ordre de leur définition.

```
@startuml
:Hello world;
:This is defined on
several lines;
@enduml
```

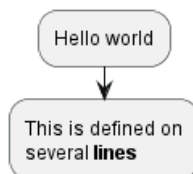

6.2 Départ/Arrêt [start, stop, end]

Vous pouvez utiliser les mots clés `start` et `stop` pour indiquer le début et la fin du diagramme.

```
@startuml
start
:Hello world;
:This is on defined on
several lines;
stop
@enduml
```

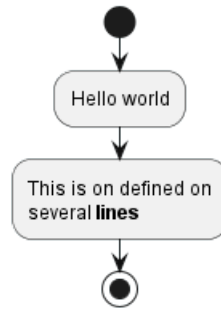

Vous pouvez aussi utiliser le mot clé `end`.

```

@startuml
start
:Hello world;
:This is on defined on
several lines;
end
@enduml
  
```

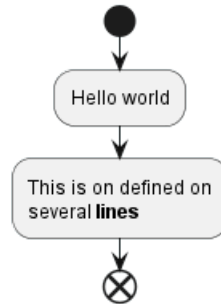

6.3 Conditionnel [if, then, else]

Vous pouvez utiliser les mots clés `if`, `then` et `else` pour mettre des tests dans votre diagramme. Les étiquettes peuvent être fournies entre parenthèses.

Les trois syntaxes possibles sont:

- `if (...) then (...)`

```

@startuml
start

if (Graphviz installed?) then (yes)
:process all\ndiagrams;
else (no)
:process only
__sequence__ and __activity__ diagrams;
endif

stop

@enduml
  
```

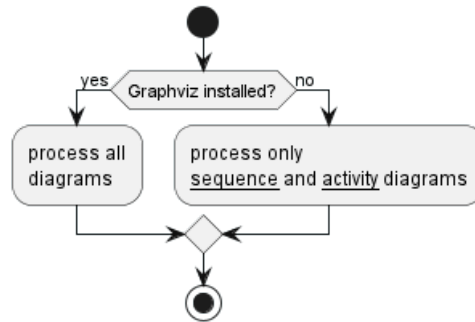

- if (...) is (...) then

```

@startuml
if (color?) is (<color:red>red) then
:print red;
else
:print not red;
@enduml
  
```

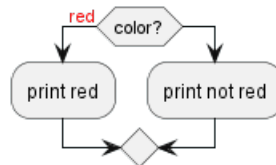

- if (...) equals (...) then

```

@startuml
if (counter?) equals (5) then
:print 5;
else
:print not 5;
@enduml
  
```

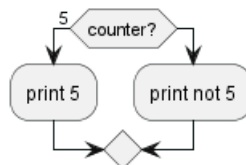

[Ref. QA-301]

6.3.1 Plusieurs conditions (en mode horizontal)

Vous pouvez utiliser le mot clé `elseif` pour avoir plusieurs tests, par défaut le mode est horizontal :

```

@startuml
start
if (condition A) then (yes)
:Text 1;
elseif (condition B) then (yes)
:Text 2;
stop
elseif (condition C) then (yes)
:Text 3;
elseif (condition D) then (yes)
:Text 4;
else (nothing)
  
```



```

:Text else;
endif
stop
@enduml

```

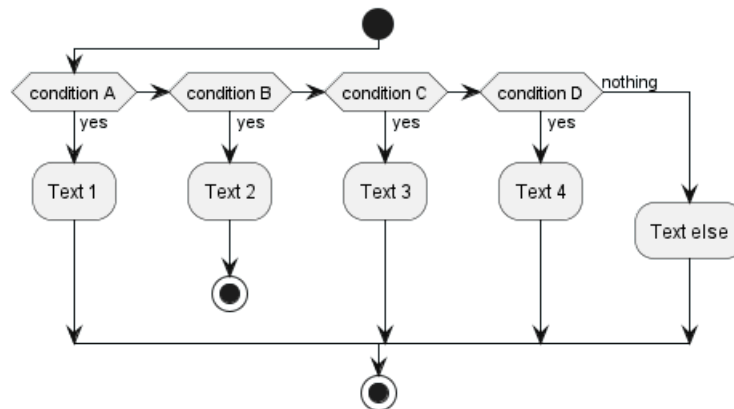

6.3.2 Plusieurs conditions (en mode vertical)

Vous pouvez utiliser la commande `!pragma useVerticalIf on` pour avoir les conditions en mode vertical :

```

@startuml
!pragma useVerticalIf on
start
if (condition A) then (yes)
:Text 1;
elseif (condition B) then (yes)
:Text 2;
stop
elseif (condition C) then (yes)
:Text 3;
elseif (condition D) then (yes)
:Text 4;
else (nothing)
:Text else;
endif
stop
@enduml

```

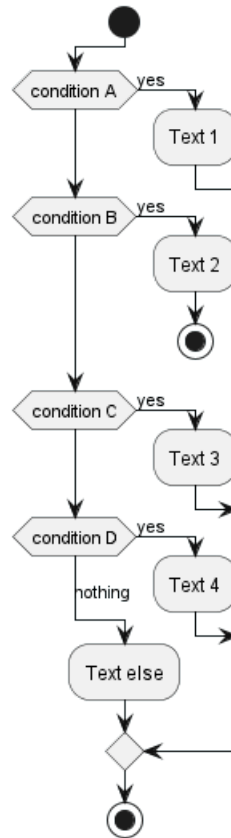

[Réf. QA-3931]

[Refs. [QA-3931](<https://forum.plantuml.net/3931/please-provide-elseif-structure-vertically-activity-diagrams>), [issue-582](<https://github.com/plantuml/plantuml/issues/582>)]

6.4 Switch and case [switch, case, endswitch]

Vous pouvez utiliser les mots clés **switch**, **case** et **endswitch** pour mettre des tests dans votre diagramme.

Les étiquettes peuvent être fournies entre parenthèses.

```

@startuml
start
switch (test?)
case ( condition A )
  :Text 1;
case ( condition B )
  :Text 2;
case ( condition C )
  :Text 3;
case ( condition D )
  :Text 4;
case ( condition E )
  :Text 5;
endswitch
stop
@enduml
  
```



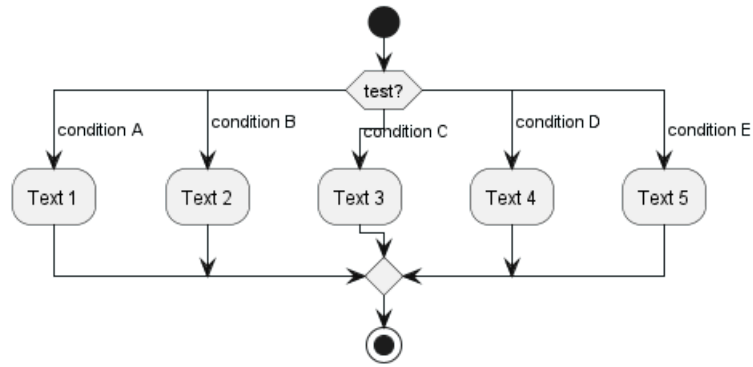

6.5 Arrêt après une action au sein d'une condition [kill, detach]

Vous pouvez arrêter le processus après une action.

```
@startuml
if (condition?) then
    :error;
    stop
endif
#palegreen:action;
@enduml
```

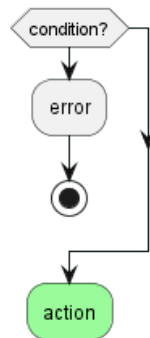

Vous pouvez également utiliser les mots clé `kill` ou `detach` pour mettre fin au processus directement dans une action.

- `kill`

```
@startuml
if (condition?) then
    #pink:error;
    kill
endif
#palegreen:action;
@enduml
```

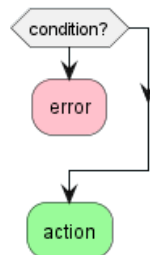

[Ref. QA-265]

- detach

```
@startuml
if (condition?) then
  #pink:error;
  detach
endif
#palegreen:action;
@enduml
```

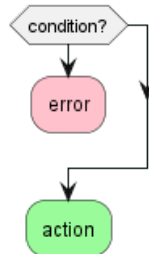

6.6 Boucle de répétition [repeat, repeatwhile, backward]

Vous pouvez utiliser les mots clés `repeat` et `repeatwhile` pour créer une boucle.

```
@startuml
start

repeat
  :read data;
  :generate diagrams;
repeat while (more data?)
stop

@enduml
```

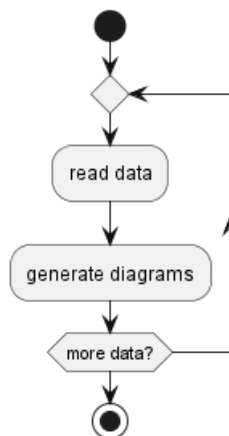

Il est également possible :

- d'utiliser une vraie action comme cible de répétition, après le premier mot clé `repeat`,
- d'insérer une action dans le chemin de retour à l'aide du mot clé `backward`.

```
@startuml
start
```



```

repeat :foo as starting label;
  :read data;
  :generate diagrams;
backward:This is backward;
repeat while (more data?)

stop

@enduml

```

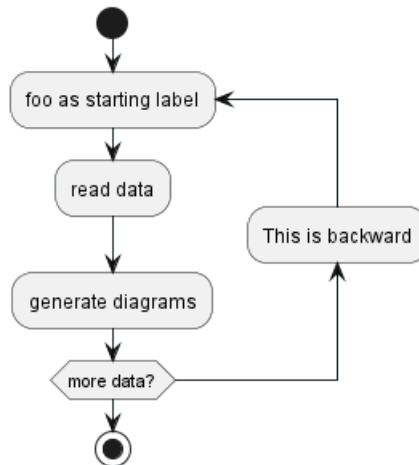

[Ref. QA-5826]

6.7 Interruption d'une boucle [break]

Vous pouvez utiliser le mot clé `break` après une action sur une boucle:

```

@startuml
start
repeat
  :Test something;
  if (Something went wrong?) then (no)
    #palegreen:OK;
    break
  endif
  ->NOK;
  :Alert "Error with long text";
repeat while (Something went wrong with long text?) is (yes) not (no)
->//merged step//;
:Alert "Success";
stop
@enduml

```

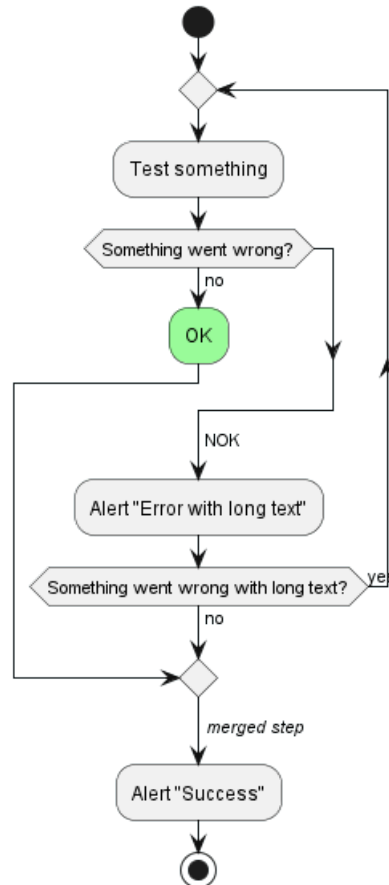
[Ref. QA-6105]

6.8 Goto and Label Processing [label, goto]

It is currently only experimental

You can use `label` and `goto` keywords to denote goto processing, with:

- `label <label_name>`
- `goto <label_name>`

```

@startuml
title Point two queries to same activity\nwith `goto`
start
if (Test Question?) then (yes)
'space label only for alignment
label sp_lab0
label sp_lab1
'real label
label lab
:shared;
else (no)
if (Second Test Question?) then (yes)
label sp_lab2
goto sp_lab1
else
:nonShared;
endif
endif
:merge;
  
```



```
@enduml
```

Point two queries to same activity
with `goto`

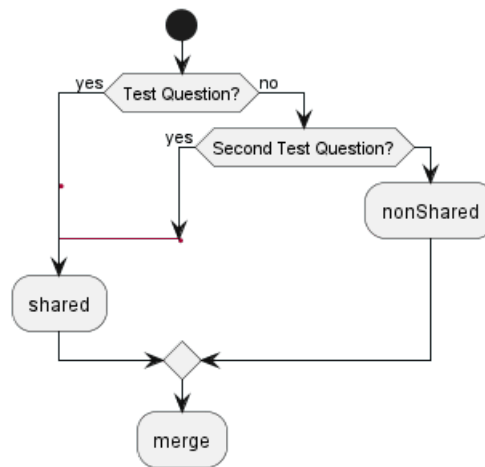

[Ref. QA-15026, QA-12526 and initially QA-1626]

6.9 Boucle « tant que » [while]

Vous pouvez utiliser les mots clés `while` et `end while` pour définir une boucle.

```
@startuml
```

```
start
```

```
while (data available?)
  :read data;
  :generate diagrams;
endwhile
```

```
stop
```

```
@enduml
```

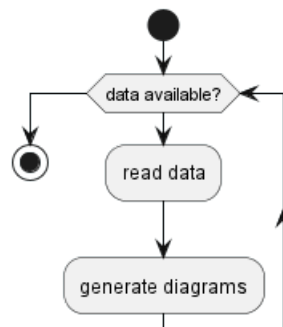

Il est possible de mettre un libellé après le mot clé `endwhile` ou bien avec le mot clé `is`.

```
@startuml
while (check filesize ?) is (not empty)
  :read file;
endwhile (empty)
:close file;
@enduml
```



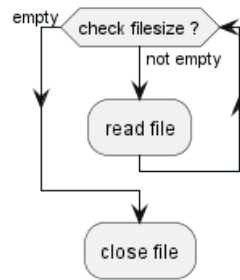

6.10 Traitement parallèle [fork, fork again, end fork, end merge]

Vous pouvez utiliser les mots clés `fork`, `fork again` et `end fork` ou `end merge` pour indiquer un traitement parallèle.

6.10.1 Simple fork

```

@startuml
start
fork
    :action 1;
fork again
    :action 2;
end fork
stop
@enduml
    
```

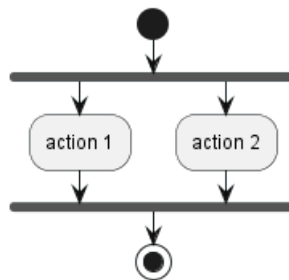

6.10.2 fork avec fusion finale

```

@startuml
start
fork
    :action 1;
fork again
    :action 2;
end merge
stop
@enduml
    
```

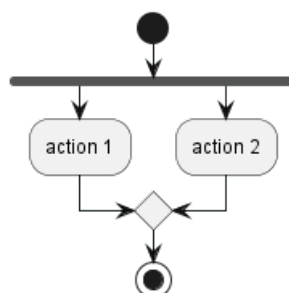

[Réf. QA-5320]

```
@startuml
start
fork
  :action 1;
fork again
  :action 2;
fork again
  :action 3;
fork again
  :action 4;
end merge
stop
@enduml
```

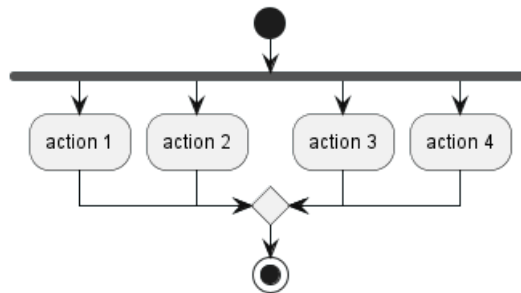

```
@startuml
start
fork
  :action 1;
fork again
  :action 2;
end
end merge
stop
@enduml
```

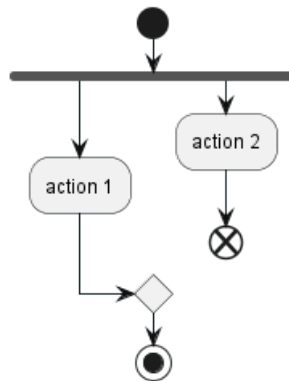

[Réf. QA-13731]

6.10.3 Label sur end fork (ou UML joinspec)

```
@startuml
start
fork
  :action A;
fork again
```

```

:action B;
end fork {or}
stop
@enduml

```

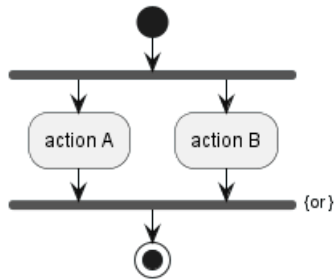

```

@startuml
start
fork
:action A;
fork again
:action B;
end fork {and}
stop
@enduml

```

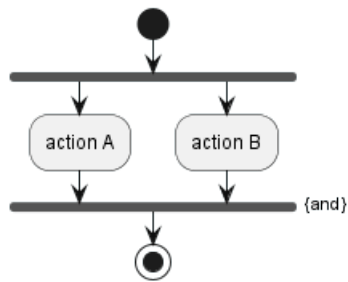

[Réf. QA-5346]

6.10.4 Autre exemple

```

@startuml
start
if (multiprocessor?) then (yes)
fork
:Treatment 1;
fork again
:Treatment 2;
end fork
else (monoproc)
:Treatment 1;
:Treatment 2;
endif
@enduml

```

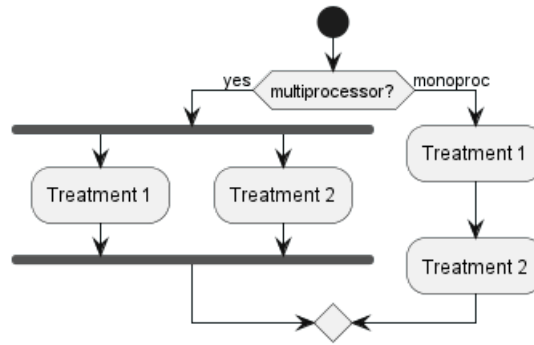

6.11 Traitement fractionné

6.11.1 Split

Vous pouvez utiliser les mots-clés `split`, `split again` et `end split` pour indiquer un traitement fractionné

```

@startuml
start
split
:A;
split again
:B;
split again
:C;
split again
:a;
:b;
end split
:D;
end
@enduml
  
```

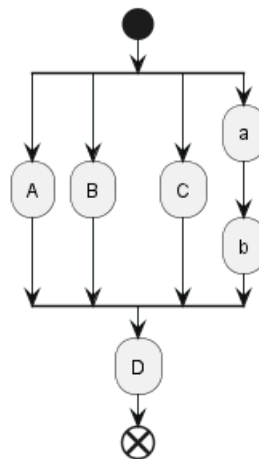

6.11.2 Fractionnement de l'entrée (multidébut)

Vous pouvez utiliser les flèches `hidden` pour effectuer un fractionnement de l'entrée (multidébut)

```

@startuml
split
-[hidden]->
:A;
split again
  
```



```

-[hidden]->
:B;
split again
-[hidden]->
:C;
end split
:D;
@enduml

```

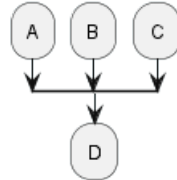

```

@startuml
split
-[hidden]->
:A;
split again
-[hidden]->
:a;
:b;
split again
-[hidden]->
(Z)
end split
:D;
@enduml

```

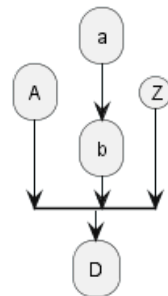

[Ref. QA-8662]

6.11.3 Fractionnement de la sortie (plusieurs extrémités)

Vous pouvez utiliser `kill` ou `detach` pour effectuer un fractionnement de la sortie (plusieurs extrémités)

```

@startuml
start
split
:A;
kill
split again
:B;
detach
split again
:C;

```



```

kill
end split
@enduml

```

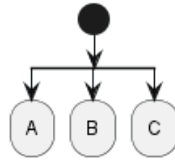

```

@startuml
start
split
  :A;
  kill
split again
  :b;
  :c;
  detach
split again
  (Z)
  detach
split again
  end
split again
  stop
end split
@enduml

```

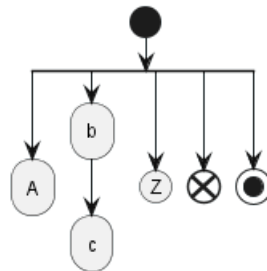

6.12 Notes

Le formatage du texte peut être fait en utilisant la syntaxe wiki créole.

Une note peut être flottante, en utilisant le mot clé `floating`

```

@startuml

start
:foo1;
floating note left: This is a note
:foo2;
note right
  This note is on several
  //lines// and can
  contain <b>HTML</b>
  ====
  * Calling the method ""foo()"" is prohibited
end note
stop

```



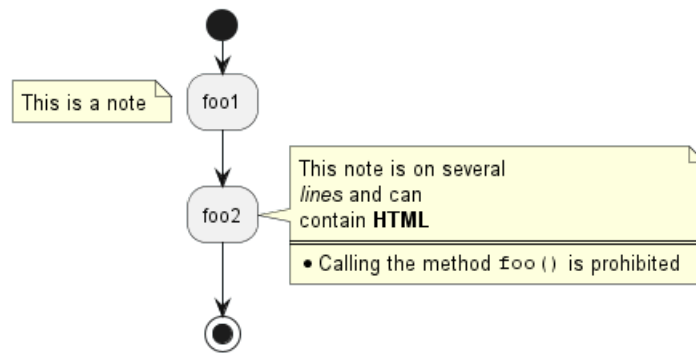

```
@enduml
```

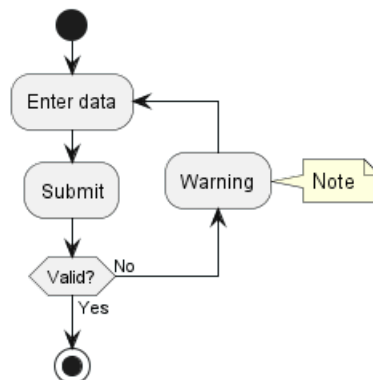

Vous pouvez ajouter une note sur l'activité de retour en arrière

```
@startuml
start
repeat :Enter data;
:Submit;
backward :Warning;
note right: Note
repeat while (Valid?) is (No) not (Yes)
stop
@enduml
```



[Ref. QA-11788]

Vous pouvez ajouter une note sur l'activité de partition

```
@startuml
start
partition "**process** HelloWorld" {
    note
        This is my note
        ----
        //Creole test//
    end note
    :Ready;
    :HelloWorld(i)>
    :Hello-Sent;
}
@enduml
```



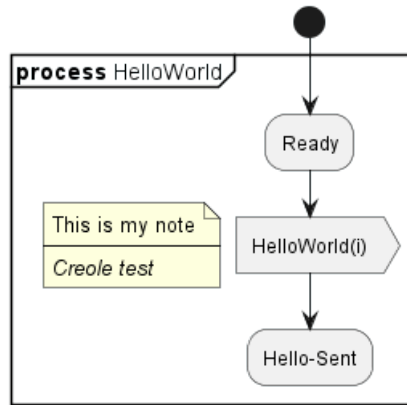

[Réf. QA-2398]

6.13 Couleurs

Vous pouvez spécifier une couleur pour certaines activités

```
@startuml
```

```

start
:starting progress;
#HotPink:reading configuration files
These files should be edited at this point!;
#AAAAAA:ending of the process;

```

```
@enduml
```

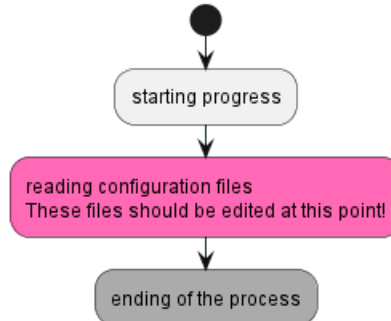

Vous pouvez également utiliser une couleur dégradée

```

@startuml
start
partition #red/white testPartition {
    #blue\green:testActivity;
}
@enduml

```

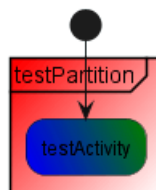

[Réf. QA-4906]



6.14 Lignes sans pointe de flèches

Vous pouvez utiliser `skinparam ArrowHeadColor none` pour connecter des activités en utilisant uniquement des lignes, sans flèches (sans pointe sur les flèches).

```
@startuml
skinparam ArrowHeadColor none
start
:Hello world;
:This is on defined on
several **lines**;
stop
@enduml
```

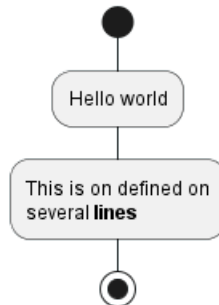

```
@startuml
skinparam ArrowHeadColor none
start
repeat :Enter data;
:Submit;
backward :Warning;
repeat while (Valid?) is (No) not (Yes)
stop
@enduml
```

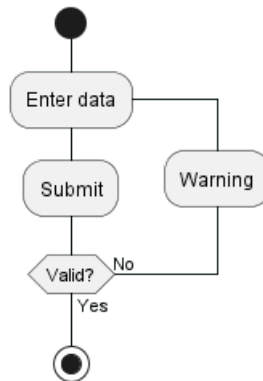

6.15 Flèches

En utilisant la notation `->`, vous pouvez ajouter du texte à une flèche, et changer sa couleur.

Il est aussi possible d'avoir des flèches en pointillé, en gras, avec des tirets ou bien complètement cachées.

```
@startuml
:foo1;
-> You can put text on arrows;
if (test) then
-[#blue]->
:foo2;
-[#green,dashed]-> The text can
```



```

also be on several lines
and very long...;
:foo3;
else
-[#black,dotted]->
:foo4;
endif
-[#gray,bold]->
:foo5;
@enduml

```

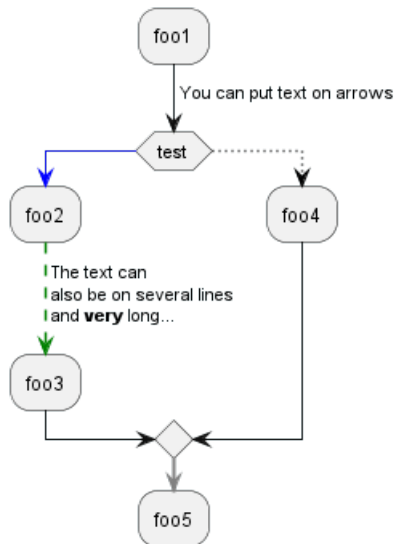

6.16 Connecteurs

Il est possible d'utiliser des parenthèses pour dessiner des connecteurs.

```

@startuml
start
:Some activity;
(A)
detach
(A)
:Other activity;
@enduml

```

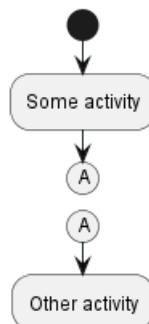

6.17 Connecteurs en couleur

Vous pouvez ajouter des couleurs aux connecteurs.

```

@startuml

```



```

start
:The connector below
wishes he was blue;
#blue:(B)
:This next connector
feels that she would
be better off green;
#green:(G)
stop
@enduml

```

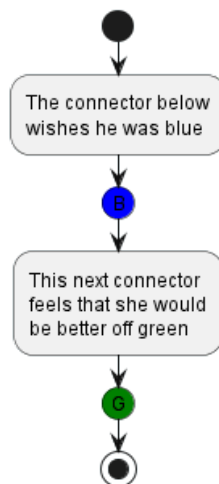

[Ref. QA-10077]

6.18 Regroupement ou partition

6.18.1 Groupe

Vous pouvez regrouper des activités en définissant un groupe

```

@startuml
start
group Initialization
:read config file;
:init internal variable;
end group
group Running group
:wait for user interaction;
:print information;
end group

stop
@enduml

```



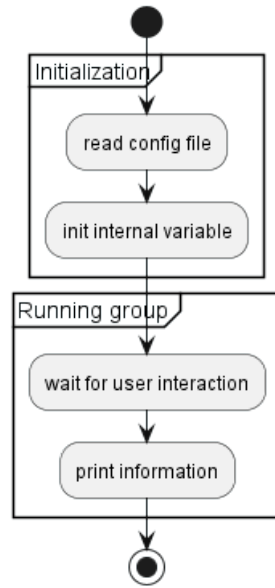

6.18.2 Partition

Vous pouvez regrouper des activités en définissant une partition

```

@startuml
start
partition Initialization {
    :read config file;
    :init internal variable;
}
partition Running {
    :wait for user interaction;
    :print information;
}
stop
@enduml
  
```

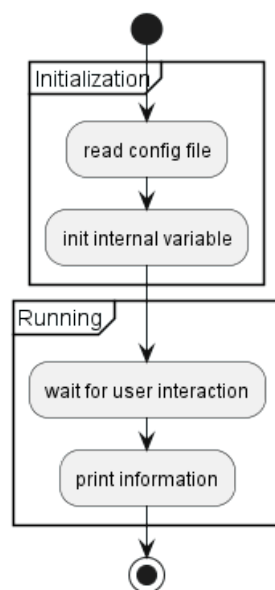

Il est également possible de changer la couleur de la partition



```

@startuml
start
partition #lightGreen "Input Interface" {
    :read config file;
    :init internal variable;
}
partition Running {
    :wait for user interaction;
    :print information;
}
stop
@enduml

```

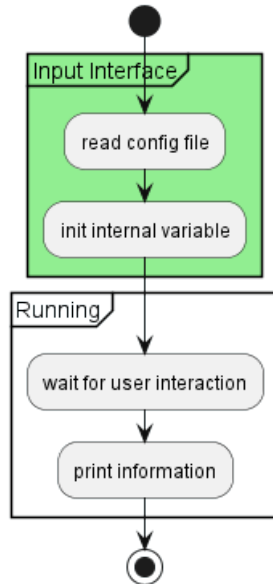

[Réf. QA-2793]

Il est également possible d'ajouter un lien à la partition

```

@startuml
start
partition "[[http://plantuml.com partition_name]]" {
    :read doc. on [[http://plantuml.com plantuml_website]];
    :test diagram;
}
end
@enduml

```

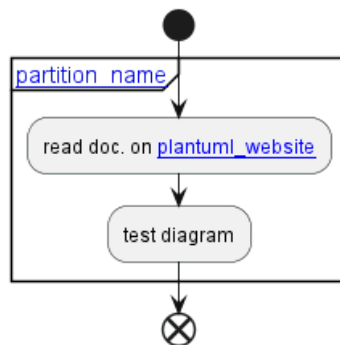

[Réf. QA-542]



6.18.3 Groupe, partition, paquet, rectangle ou carte

Vous pouvez regrouper des activités en définissant :

- groupe ;
- partition ;
- paquet ;
- rectangle ;
- carte

```
@startuml
start
group Group
  :Activity;
end group
floating note: Note on Group

partition Partition {
  :Activity;
}
floating note: Note on Partition

package Package {
  :Activity;
}
floating note: Note on Package

rectangle Rectangle {
  :Activity;
}
floating note: Note on Rectangle

card Card {
  :Activity;
}
floating note: Note on Card
end
@enduml
```

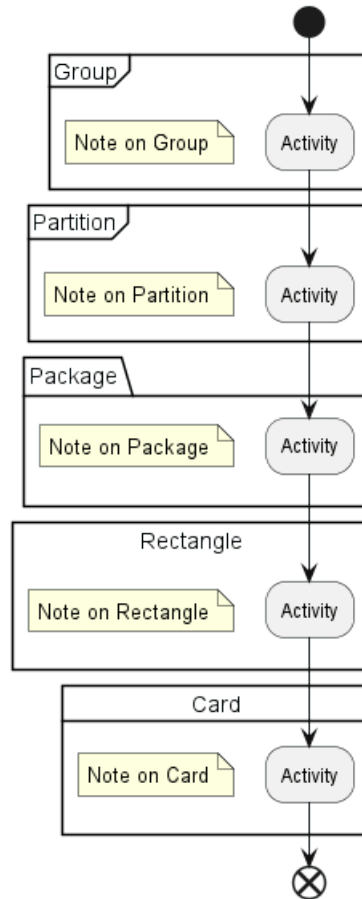
6.19 Swimlanes

En utilisant le tube |, vous pouvez définir des swimlanes.

Il est également possible de changer la couleur des swimlanes

```

@startuml
|Swimlane1|
start
:foo1;
|#AntiqueWhite|Swimlane2|
:foo2;
:foo3;
|Swimlane1|
:foo4;
|Swimlane2|
:foo5;
stop
@enduml
  
```

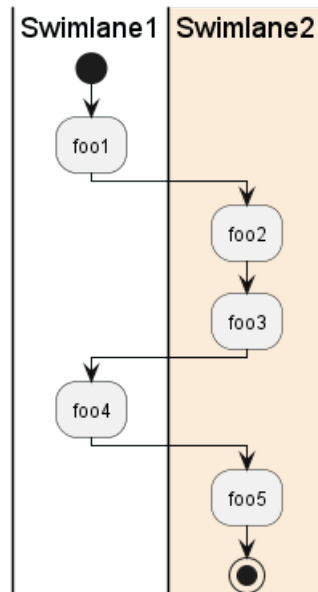

Vous pouvez ajouter une boucle conditionnelle `if` ou `repeat` ou `while` à l'intérieur des swimlanes

```

@startuml
|#pink|Actor_For_red|
start
if (color?) is (red) then
#pink:**action red**;
:foo1;
else (not red)
|#lightgray|Actor_For_no_red|
#lightgray:**action not red**;
:foo2;
endif
|Next_Actor|
#lightblue:foo3;
:foo4;
|Final_Actor|
#palegreen:foo5;
stop
@enduml
  
```

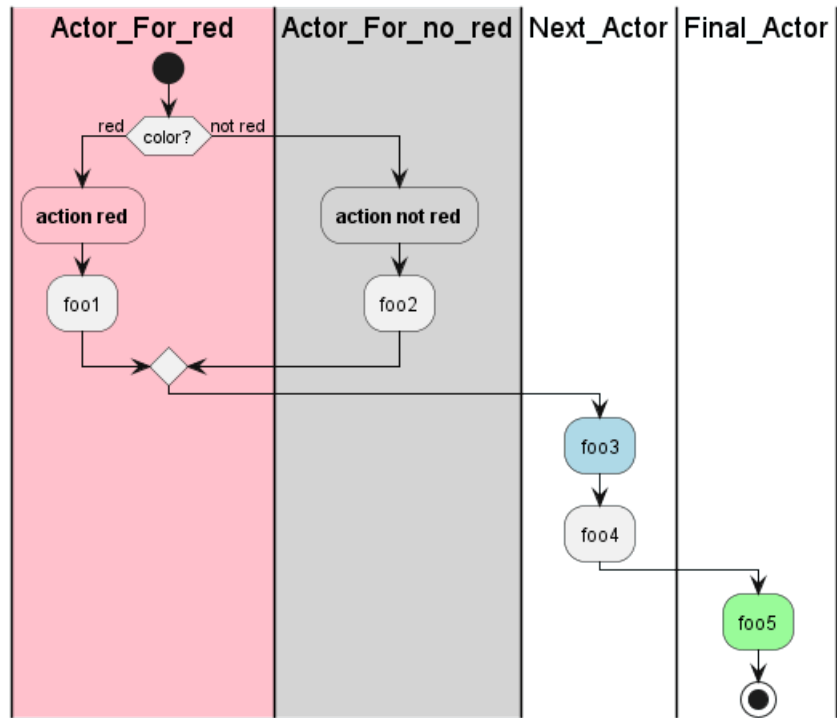

Vous pouvez également utiliser `alias` avec les swimlanes, avec cette syntaxe :

- |[#<color>|]<swimlane_alias>| <swimlane_title>

```
@startuml
|#palegreen|f| fisherman
|c| cook
|#gold|e| eater
|f|
start
:go fish;
|c|
:fry fish;
|e|
:eat fish;
stop
@enduml
```

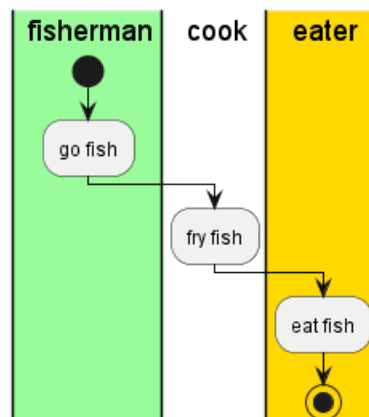

[Réf. QA-2681]

6.20 Détacher ou arrêter [*detach*, *kill*]

Il est possible de supprimer une flèche en utilisant le mot clé *detach* ou *kill* :

- *detach*

```
@startuml
: start;
fork
: foo1;
: foo2;
fork again
: foo3;
detach
endifork
if (foo4) then
: foo5;
detach
endif
: foo6;
detach
: foo7;
stop
@enduml
```

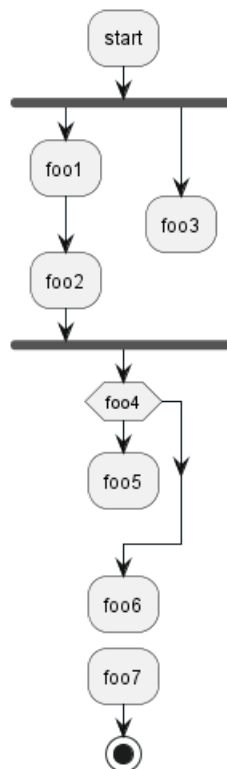

- *kill*

```
@startuml
: start;
fork
: foo1;
: foo2;
fork again
: foo3;
kill
endifork
: foo6;
stop
@enduml
```



```

endfork
if (foo4) then
  :foo5;
  kill
endif
:foo6;
kill
:foo7;
stop
@enduml

```

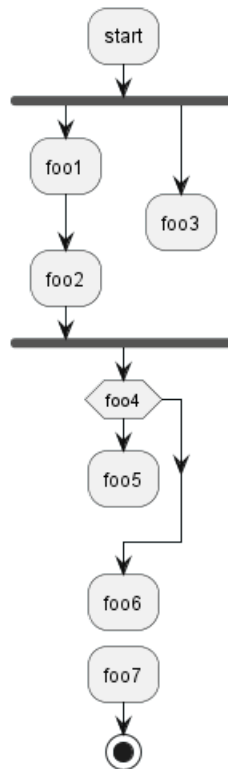

6.21 SDL (Specification and Description Language)

En changeant le séparateur final ;, vous pouvez déterminer différents rendus pour l'activité, conformément au *langage de description et de spécification (LDS)* ou *Specification and Description Language (SDL)* (en anglais) :

- |
- <
- >
- /
- \\
-]
- }

```

@startuml
:Ready;
:next(o)|
:Receiving;
split
:nak(i)<

```



```

:ack(o)>
split again
:ack(i)<
:next(o)
on several line|
:i := i + 1]
:ack(o)>
split again
:err(i)<
:nak(o)>
split again
:foo/
split again
:bar\\
split again
:i > 5}
stop
end split
:finish;
@enduml

```

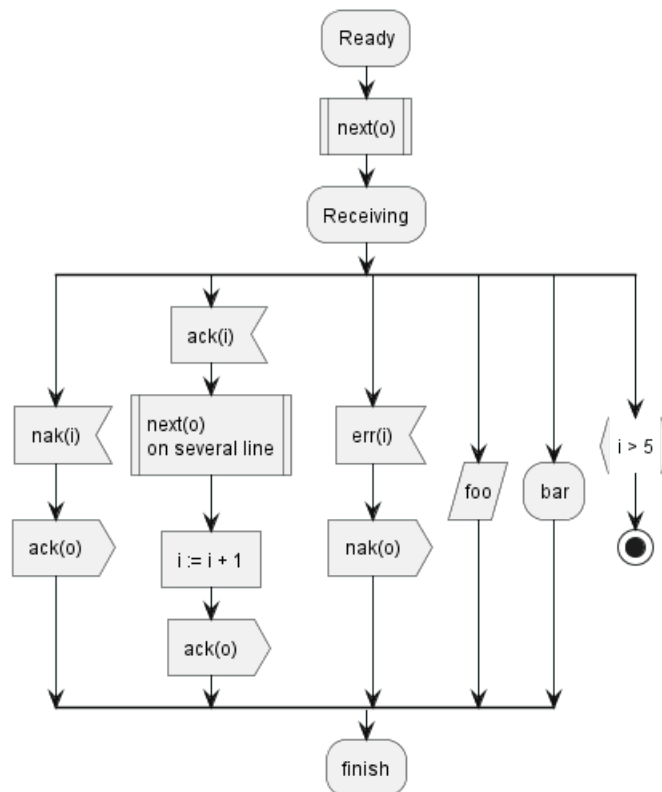

6.22 Exemple complet

```

@startuml
start
:ClickServlet.handleRequest();
:new page;
if (Page.onSecurityCheck) then (true)
:Page.onInit();
if (isForward?) then (no)
:Process controls;

```



```
    if (continue processing?) then (no)
        stop
    endif

    if (isPost?) then (yes)
        :Page.onPost();
    else (no)
        :Page.onGet();
    endif
    :Page.onRender();
endif
else (false)
endif

if (do redirect?) then (yes)
    :redirect process;
else
    if (do forward?) then (yes)
        :Forward request;
    else (no)
        :Render page template;
    endif
endif

stop

@enduml
```

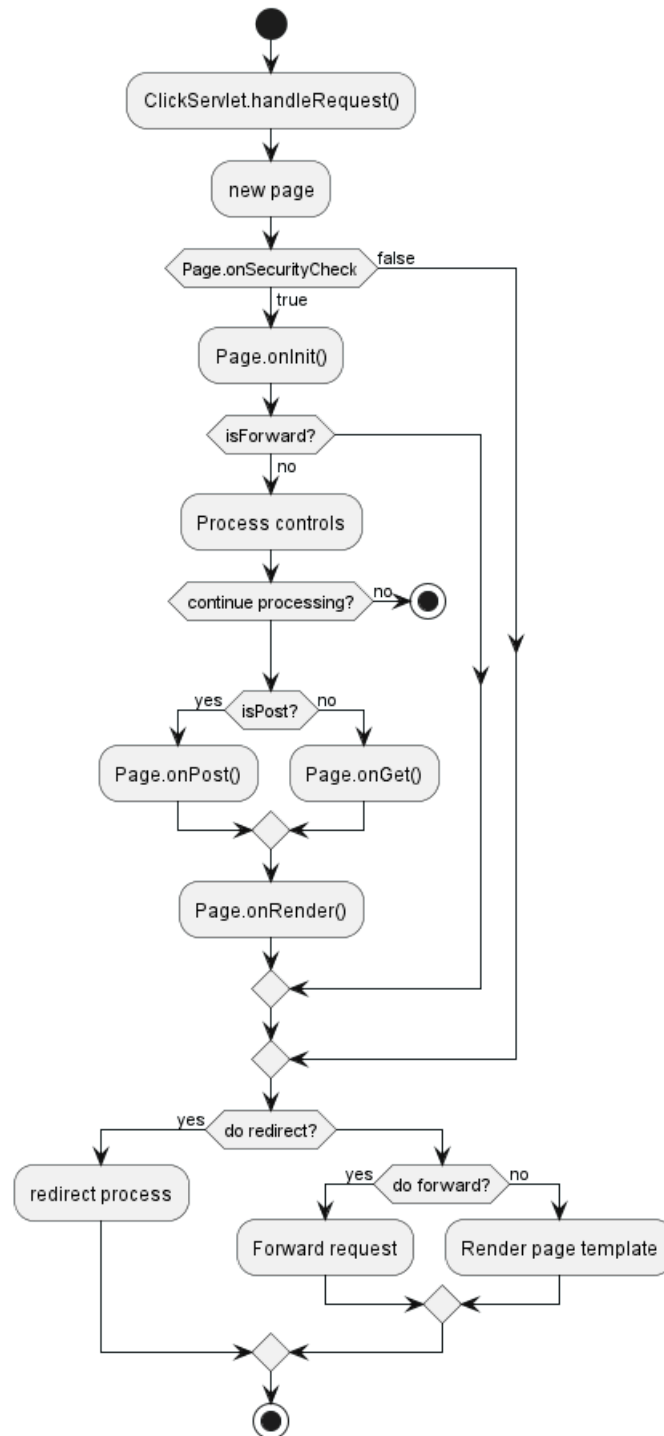

6.23 Style de condition

6.23.1 Style intérieur (par défaut)

```

@startuml
skinparam conditionStyle inside
start
repeat
  :act1;
  :act2;
repeatwhile (<b>end)
:act3;
  
```



```
@enduml
```

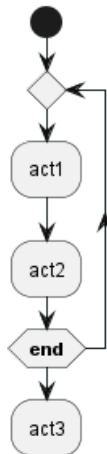

```
@startuml
start
repeat
  :act1;
  :act2;
repeatwhile (<b>end)
:act3;
@enduml
```

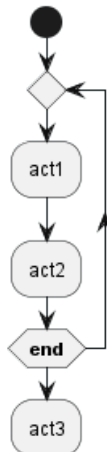

6.23.2 Style diamant

```
@startuml
skinparam conditionStyle diamond
start
repeat
  :act1;
  :act2;
repeatwhile (<b>end)
:act3;
@enduml
```

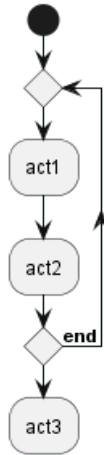

6.23.3 Style InsideDiamond (ou Foo1)

```

@startuml
skinparam conditionStyle InsideDiamond
start
repeat
  :act1;
  :act2;
repeatwhile (<b>end)
:act3;
@enduml
  
```

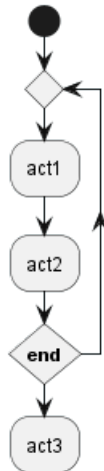

```

@startuml
skinparam conditionStyle foo1
start
repeat
  :act1;
  :act2;
repeatwhile (<b>end)
:act3;
@enduml
  
```

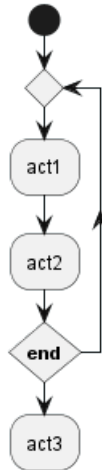

Ref. QA-1290 et #400]

6.24 Style de fin de condition

6.24.1 Style diamant (par défaut)

- Avec une branche

```
@startuml
skinparam ConditionEndStyle diamond
:A;
if (decision) then (yes)
    :B1;
else (no)
endif
:C;
@enduml
```

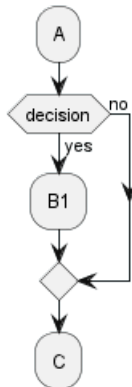

- Avec deux branches (B1, B2)

```
@startuml
skinparam ConditionEndStyle diamond
:A;
if (decision) then (yes)
    :B1;
else (no)
    :B2;
endif
:C;
@enduml
@enduml
```



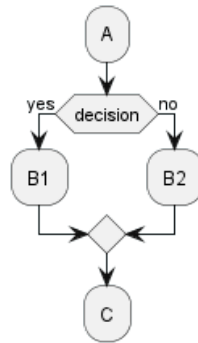

6.24.2 Style ligne horizontale (hline)

- Avec une branche

```

@startuml
skinparam ConditionEndStyle hline
:A;
if (decision) then (yes)
    :B1;
else (no)
endif
:C;
@enduml
  
```

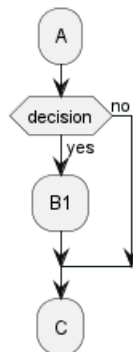

- Avec deux branches (B1, B2)

```

@startuml
skinparam ConditionEndStyle hline
:A;
if (decision) then (yes)
    :B1;
else (no)
    :B2;
endif
:C;
@enduml
  
```

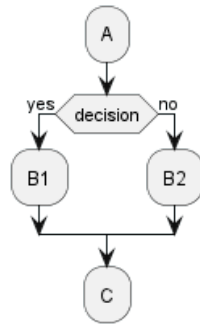

[Réf. QA-4015]

6.25 Avec le style (global)

6.25.1 Sans style (par défaut)

```

@startuml
start
:init;
-> test of color;
if (color?) is (<color:red>red) then
:print red;
else
:print not red;
note right: no color
endif
partition End {
:end;
}
-> this is the end;
end
@enduml
  
```

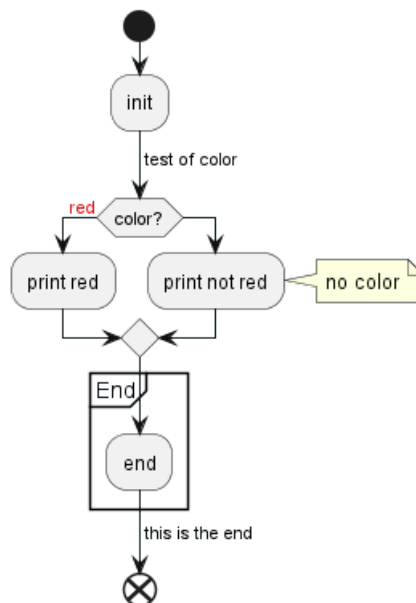

6.25.2 Avec style

Vous pouvez utiliser le style pour modifier le rendu des éléments.

```
@startuml
```



```
<style>
activityDiagram {
  BackgroundColor #33668E
  BorderColor #33668E
  FontColor #888
  FontName arial

  diamond {
    BackgroundColor #ccf
    LineColor #00FF00
    FontColor green
    FontName arial
    FontSize 15
  }
  arrow {
    FontColor gold
    FontName arial
    FontSize 15
  }
  partition {
    LineColor red
    FontColor green
    RoundCorner 10
    BackgroundColor PeachPuff
  }
  note {
    FontColor Blue
    LineColor Navy
    BackgroundColor #ccf
  }
}
document {
  BackgroundColor transparent
}
</style>
start
:init;
-> test of color;
if (color?) is (<color:red>red) then
:print red;
else
:print not red;
note right: no color
endif
partition End {
:end;
}
-> this is the end;
end
@enduml
```

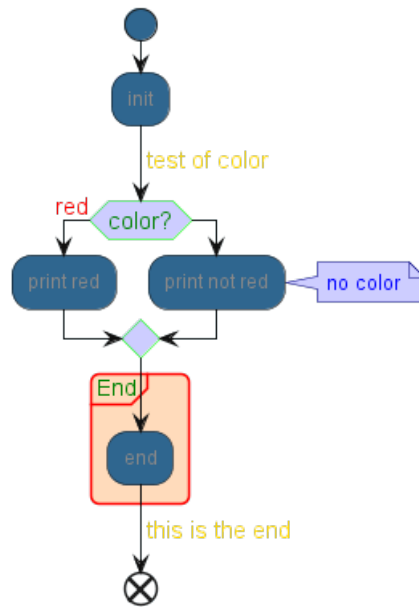

7 Diagrammes de composants

Prenons quelques exemples.

Advantages of PlantUML:

- **Simplicity:** With PlantUML, you can create component diagrams using simple and intuitive text-based descriptions, eliminating the need for complex drawing tools.
- **Integration:** PlantUML seamlessly integrates with various tools and platforms, making it a versatile choice for developers and architects.
- **Collaboration:** The [PlantUML forum](https://forum.plantuml.net/) offers a platform for users to discuss, share, and seek assistance on their diagrams, fostering a collaborative community.

7.1 Composants

Les composants doivent être mis entre parenthèses.

Vous pouvez également utiliser le mot-clé `component` pour définir un composant . Et vous pouvez définir un alias, en utilisant le mot-clé `as` . Cet alias sera utilisé plus tard, lors de la définition des relations

```
@startuml
[First component]
[Another component] as Comp2
component Comp3
component [Last\ncomponent] as Comp4
@enduml
```

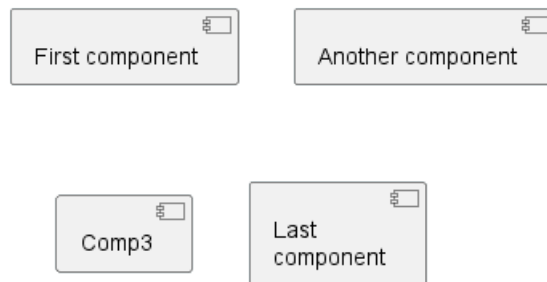

7.2 Interfaces

Les interfaces sont définies à l'aide du symbole `()` (parce que cela ressemble à un cercle).

Vous pouvez aussi utiliser le mot-clé `interface` pour définir une interface. Vous pouvez aussi définir un alias, à l'aide du mot-clé `as`. Cet alias pourrait être utilisé plus tard, lors de la définition des relations.

Nous verrons plus tard qu'il n'est pas obligatoire de définir les interfaces.

```
@startuml
() "First Interface"
() "Another interface" as Interf2
interface Interf3
interface "Last\ninterface" as Interf4

[component]
footer //Adding "component" to force diagram to be a **component diagram**//
@enduml
```



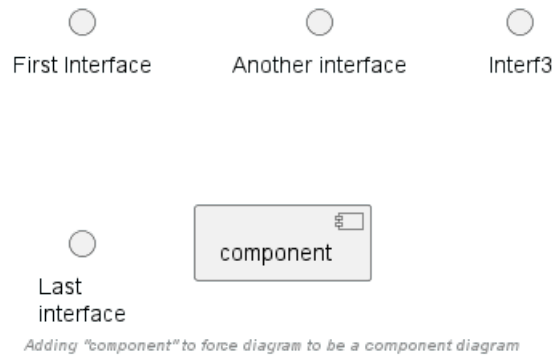

7.3 Exemple de base

Les liens entre les éléments sont établis à l'aide de combinaisons de symboles de lignes pointillées (..), de lignes droites (--) et de flèches (-->)

```
@startuml
```

```
DataAccess - [First Component]
[First Component] ..> HTTP : use
```

```
@enduml
```

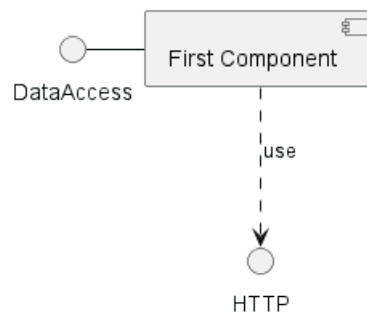

7.4 Utilisation des notes

Vous pouvez utiliser les mots-clés `note left of`, `note right of`, `note top of`, `note bottom of` pour définir des notes relatives à un seul objet.

Une note peut également être définie seule avec les mots-clés `note`, puis liée à d'autres objets à l'aide du symbole `..`.

```
@startuml
```

```
interface "Data Access" as DA
```

```
DA - [First Component]
[First Component] ..> HTTP : use
```

```
note left of HTTP : Web Service only
```

```
note right of [First Component]
  A note can also
  be on several lines
end note
```

```
@enduml
```



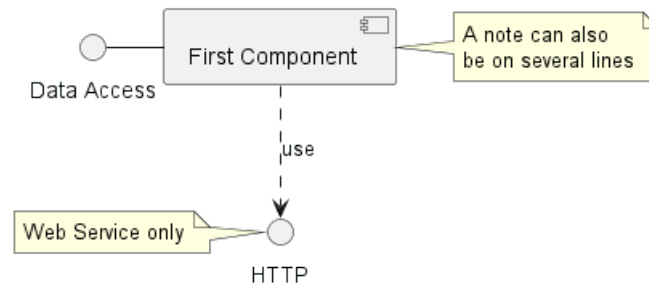

7.5 Regroupement de composants

Vous pouvez utiliser plusieurs mots-clés pour regrouper des composants et des interfaces

- package
- node
- folder
- frame
- cloud
- database

```
@startuml
```

```
package "Some Group" {
    HTTP - [First Component]
    [Another Component]
}
```

```
node "Other Groups" {
    FTP - [Second Component]
    [First Component] --> FTP
}
```

```
cloud {
    [Example 1]
}
```

```
database "MySQL" {
    folder "This is my folder" {
        [Folder 3]
    }
    frame "Foo" {
        [Frame 4]
    }
}
```

```
[Another Component] --> [Example 1]
[Example 1] --> [Folder 3]
[Folder 3] --> [Frame 4]
```

```
@enduml
```



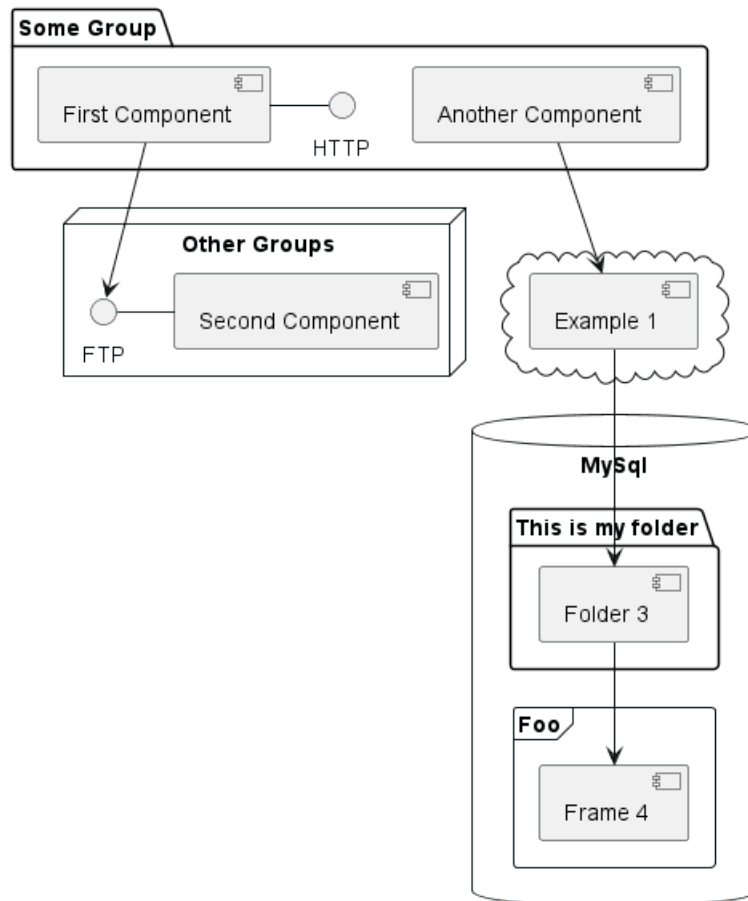

7.6 Changement de direction des flèches

Par défaut, les liens entre les classes ont deux tirets -- et sont orientés verticalement. Il est possible d'utiliser un lien horizontal en mettant un seul tiret (ou point) comme ceci

```
@startuml
[Component] --> Interface1
[Component] -> Interface2
@enduml
```

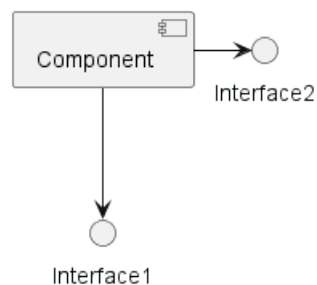

Vous pouvez également changer de direction en inversant le lien :

```
@startuml
Interface1 <-- [Component]
Interface2 <- [Component]
@enduml
```

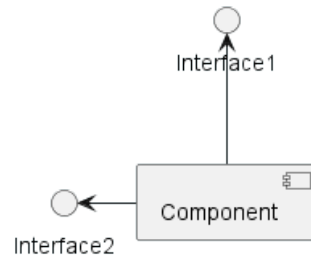

Il est également possible de changer la direction de la flèche en ajoutant les mots-clés `left`, `right`, `up` ou `down` à l'intérieur de la flèche

```

@startuml
[Component] -left-> left
[Component] -right-> right
[Component] -up-> up
[Component] -down-> down
@enduml
  
```

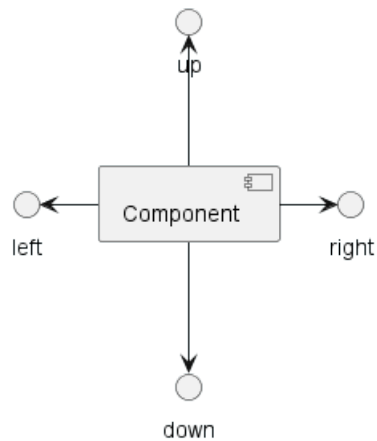

Vous pouvez raccourcir la flèche en utilisant uniquement le premier caractère de la direction (par exemple, `-d-` au lieu de `-down-`) ou les deux premiers caractères (`-do-`).

Veillez noter que vous ne devez pas abuser de cette fonctionnalité : *Graphviz* donne généralement de bons résultats sans modification.

Et avec le paramètre `left to right direction` paramètre

```

@startuml
left to right direction
[Component] -left-> left
[Component] -right-> right
[Component] -up-> up
[Component] -down-> down
@enduml
  
```

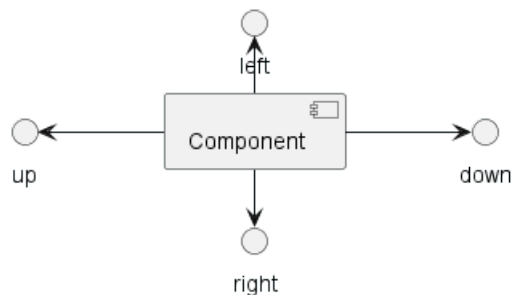

7.7 Utiliser la notation UML2

Par défaut (à partir de la version v1.2020.13-14), la notation UML2 est utilisée.

```
@startuml
interface "Data Access" as DA

DA - [First Component]
[First Component] ..> HTTP : use

@enduml
```

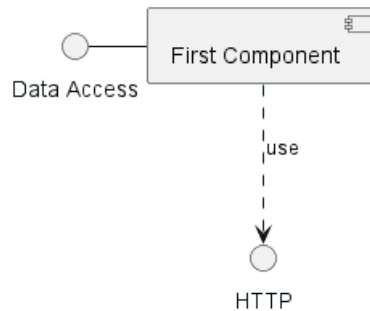

7.8 Utiliser la notation UML1

La commande `skinparam componentStyle uml1` est utilisée pour passer à la notation UML1

```
@startuml
skinparam componentStyle uml1

interface "Data Access" as DA

DA - [First Component]
[First Component] ..> HTTP : use

@enduml
```

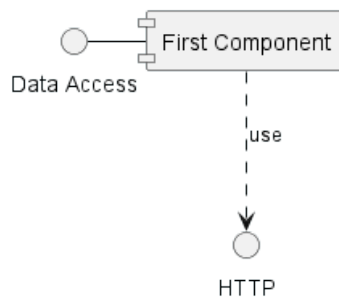

7.9 Utiliser le style rectangle (supprime toute notation UML)

La commande `skinparam componentStyle rectangle` est utilisée pour changer vers le style rectangle (sans aucune notation UML).

```
@startuml
skinparam componentStyle rectangle

interface "Data Access" as DA

DA - [First Component]
[First Component] ..> HTTP : use
```



```
@enduml
```

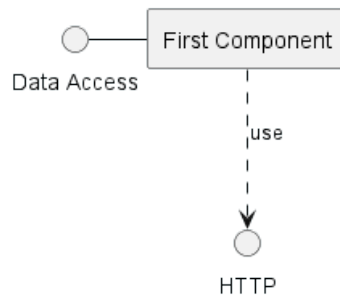

7.10 Description longue

Il est possible de mettre un long texte sur plusieurs lignes en utilisant des crochets.

```
@startuml
component comp1 [
This component
has a long comment
on several lines
]
@enduml
```

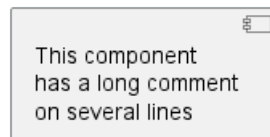

7.11 Couleurs individuelles

Vous pouvez spécifier une couleur après la définition du composant

```
@startuml
component [Web Server] #Yellow
@enduml
```



7.12 Sprites et stéréotypes

Vous pouvez utiliser des sprites dans les stéréotypes des composants.

```
@startuml
sprite $businessProcess [16x16/16] {
FFFFFFFFFFFFFFFF
FFFFFFFFFFFFFFFF
FFFFFFFFFFFFFFFF
FFFFFFFFFFFFFFFF
FFFFFFFFFOFFFF
FFFFFFFFFOFFFF
FF0000000000FF
FF0000000000FF
FF0000000000FF
FFFFFFFFFOFFFF
FFFFFFFFFOFFFF
FFFFFFFFFFFFFFFF
}
@enduml
```



```

FFFFFFFFFFFFFFFF
FFFFFFFFFFFFFFFF
FFFFFFFFFFFFFFFF
FFFFFFFFFFFFFFFF
}

```

```

rectangle " End to End\nbusiness process" <<$businessProcess>> {
  rectangle "inner process 1" <<$businessProcess>> as src
  rectangle "inner process 2" <<$businessProcess>> as tgt
  src -> tgt
}
@enduml

```

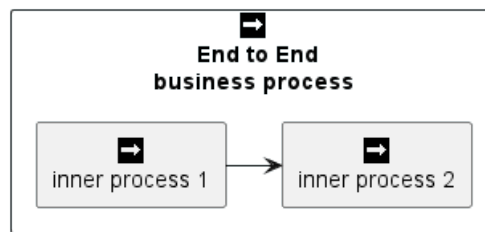

7.13 Skinparam

Vous pouvez utiliser la commande skinparam pour modifier les couleurs et les polices du dessin.

Vous pouvez utiliser cette commande :

- Dans la définition du diagramme, comme toutes les autres commandes ;
- Dans un fichier inclus;
- Dans un fichier de configuration, fourni dans la ligne de commande ou la tâche Ant.

Vous pouvez définir des couleurs et des polices spécifiques pour les composants et les interfaces stéréotypés

```
@startuml
```

```

skinparam interface {
  backgroundColor RosyBrown
  borderColor orange
}

```

```

skinparam component {
  FontSize 13
  BackgroundColor<<Apache>> Pink
  BorderColor<<Apache>> #FF6655
  FontName Courier
  BorderColor black
  BackgroundColor gold
  ArrowFontName Impact
  ArrowColor #FF6655
  ArrowFontColor #777777
}

```

```

() "Data Access" as DA
Component "Web Server" as WS << Apache >>

```

```

DA - [First Component]
[First Component] ..> () HTTP : use
HTTP - WS

```



```
@enduml
```

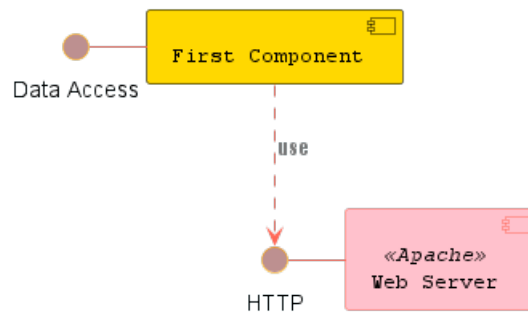

```
@startuml
```

```
skinparam component {
    backgroundColor<<static_lib>> DarkKhaki
    backgroundColor<<shared_lib>> Green
}
```

```
skinparam node {
    borderColor Green
    backgroundColor Yellow
    backgroundColor<<shared_node>> Magenta
}
skinparam databaseBackgroundColor Aqua
```

```
[AA] <<static_lib>>
[BB] <<shared_lib>>
[CC] <<static_lib>>
```

```
node node1
node node2 <<shared node>>
database Production
```

```
@enduml
```

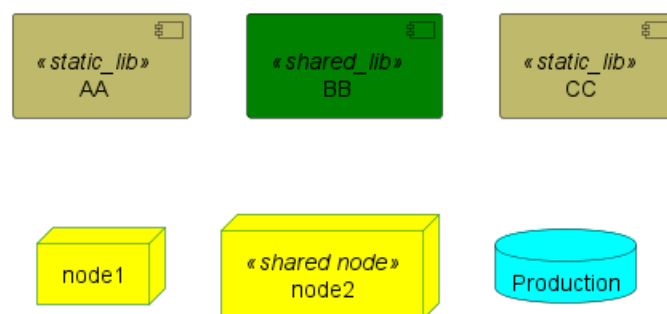

7.14 Paramètre de style spécifique

7.14.1 componentStyle

- Par défaut (ou avec `skinparam componentStyle uml2`), vous avez une icône pour le composant

```
@startuml
skinparam BackgroundColor transparent
skinparam componentStyle uml2
component A {
    component "A.1" {
```



```

}
  component A.44 {
    [A4.1]
  }
  component "A.2"
  [A.3]
  component A.5 [
A.5]
  component A.6 [
]
}
[a]->[b]
@enduml

```

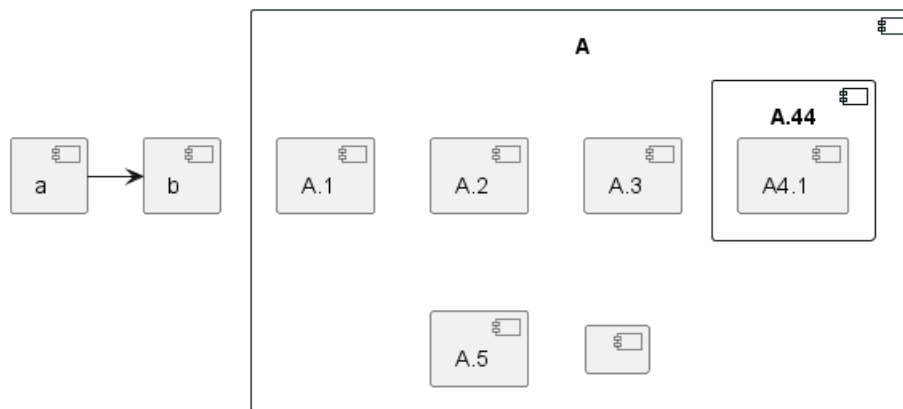

- Si vous voulez la supprimer, et n'avoir que le rectangle, vous pouvez utiliser `skinparam componentStyle rectangle`

```

@startuml
skinparam BackgroundColor transparent
skinparam componentStyle rectangle
component A {
  component "A.1" {
  }
  component A.44 {
    [A4.1]
  }
  component "A.2"
  [A.3]
  component A.5 [
A.5]
  component A.6 [
]
}
[a]->[b]
@enduml

```

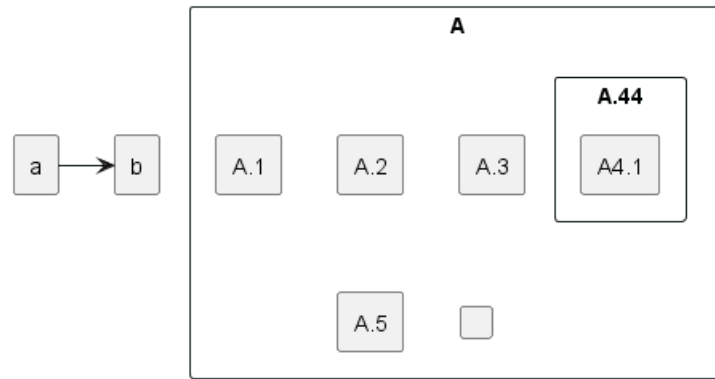

Ref. 10798]

7.15 Masquer ou supprimer un composant non lié

Par défaut, tous les composants sont affichés

```

@startuml
component C1
component C2
component C3
C1 -- C2
@enduml
  
```

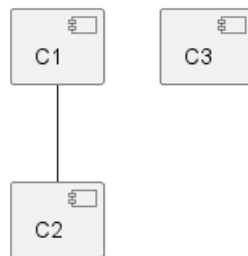

Mais vous pouvez :

- `hide @unlinked` cacher des composants

```

@startuml
component C1
component C2
component C3
C1 -- C2

hide @unlinked
@enduml
  
```



- ou `remove @unlinked` supprimer des composants

```

@startuml
component C1
component C2
  
```



```

component C3
C1 -- C2

remove @unlinked
@enduml

```



[Réf. QA-11052]

7.16 Masquer, supprimer ou restaurer un composant balisé ou un joker

Vous pouvez placer `$tags` (en utilisant `$`) sur des composants, puis supprimer, masquer ou restaurer des composants individuellement ou par balises.

Par défaut, tous les composants sont affichés

```

@startuml
component C1 $tag13
component C2
component C3 $tag13
C1 -- C2
@enduml

```

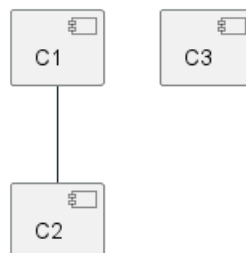

Mais vous pouvez :

- `hide $tag13` composants

```

@startuml
component C1 $tag13
component C2
component C3 $tag13
C1 -- C2

hide $tag13
@enduml

```



- ou remove \$tag13 composants

```
@startuml
component C1 $tag13
component C2
component C3 $tag13
C1 -- C2
```

```
remove $tag13
@enduml
```



- ou remove \$tag13 and restore \$tag1 composants

```
@startuml
component C1 $tag13 $tag1
component C2
component C3 $tag13
C1 -- C2
```

```
remove $tag13
restore $tag1
@enduml
```



- ou remove * and restore \$tag1 composants

```
@startuml
component C1 $tag13 $tag1
component C2
component C3 $tag13
C1 -- C2
```

```
remove *
restore $tag1
@enduml
```

[Réf. QA-7337 et QA-11052]

7.17 Display JSON Data on Component diagram

7.17.1 Simple example

```
@startuml
allowmixing

component Component
()      Interface

json JSON {
```



```

    "fruit": "Apple",
    "size": "Large",
    "color": ["Red", "Green"]
  }
@enduml

```



JSON	
fruit	Apple
size	Large
color	Red
	Green

[Ref. QA-15481]

For another example, see on JSON page.

7.18 Port [port, portIn, portOut]

You can add **port** with **port**, **portIn** and **portOut** keywords.

7.18.1 Port

```

@startuml
[c]
component C {
  port p1
  port p2
  port p3
  component c1
}

```

```

c --> p1
c --> p2
c --> p3
p1 --> c1
p2 --> c1
@enduml

```

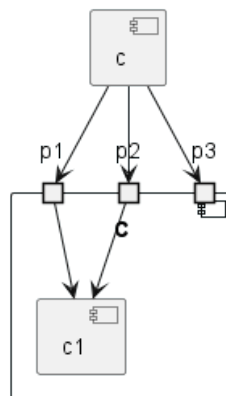

7.18.2 PortIn

```

@startuml
[c]
component C {
  portin p1
  portin p2
  portin p3
  component c1
}

```

```

c --> p1
c --> p2
c --> p3
p1 --> c1
p2 --> c1
@enduml

```

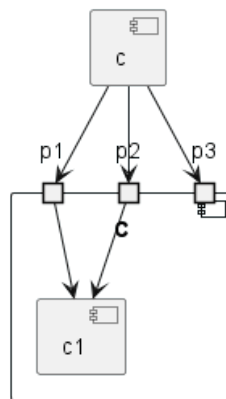

7.18.3 PortOut

```

@startuml
component C {
  portout p1
  portout p2
  portout p3
  component c1
}

```

```

[o]
p1 --> o
p2 --> o
p3 --> o
c1 --> p1
@enduml

```

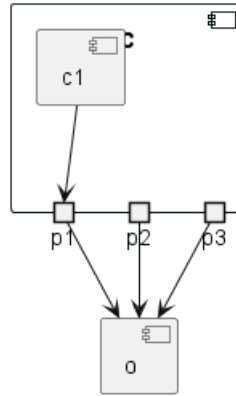

7.18.4 Mixing PortIn & PortOut

```

@startuml
[i]
component C {
  portin p1
  portin p2
  portin p3
  portout po1
  portout po2
  portout po3
  component c1
}
[o]

i --> p1
i --> p2
i --> p3
p1 --> c1
p2 --> c1
po1 --> o
po2 --> o
po3 --> o
c1 --> po1
@enduml
  
```

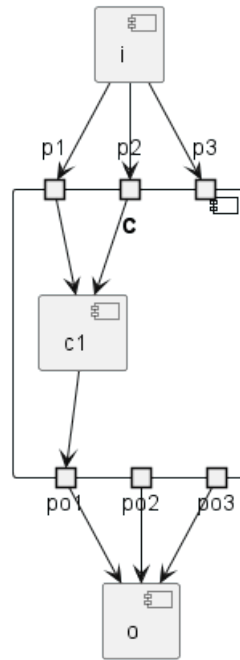

8 Diagramme de déploiement

With [PlantUML](<https://plantuml.com/en/deployment-diagram>), creating deployment diagrams becomes a breeze. The platform offers a simple and intuitive way to design these diagrams using plain text, ensuring rapid iterations and easy version control. Moreover, the [PlantUML forum](<https://forum.plantuml.net/>) provides a vibrant community where users can seek help, share ideas, and collaborate on diagramming challenges. One of the key advantages of PlantUML is its ability to integrate seamlessly with various tools and platforms, making it a preferred choice for professionals and enthusiasts alike.

8.1 Déclarer un élément

```
@startuml
actor actor
actor/ "actor/"
agent agent
artifact artifact
boundary boundary
card card
circle circle
cloud cloud
collections collections
component component
control control
database database
entity entity
file file
folder folder
frame frame
hexagon hexagon
interface interface
label label
node node
package package
person person
queue queue
rectangle rectangle
stack stack
storage storage
usecase usecase
usecase/ "usecase/"
@enduml
```



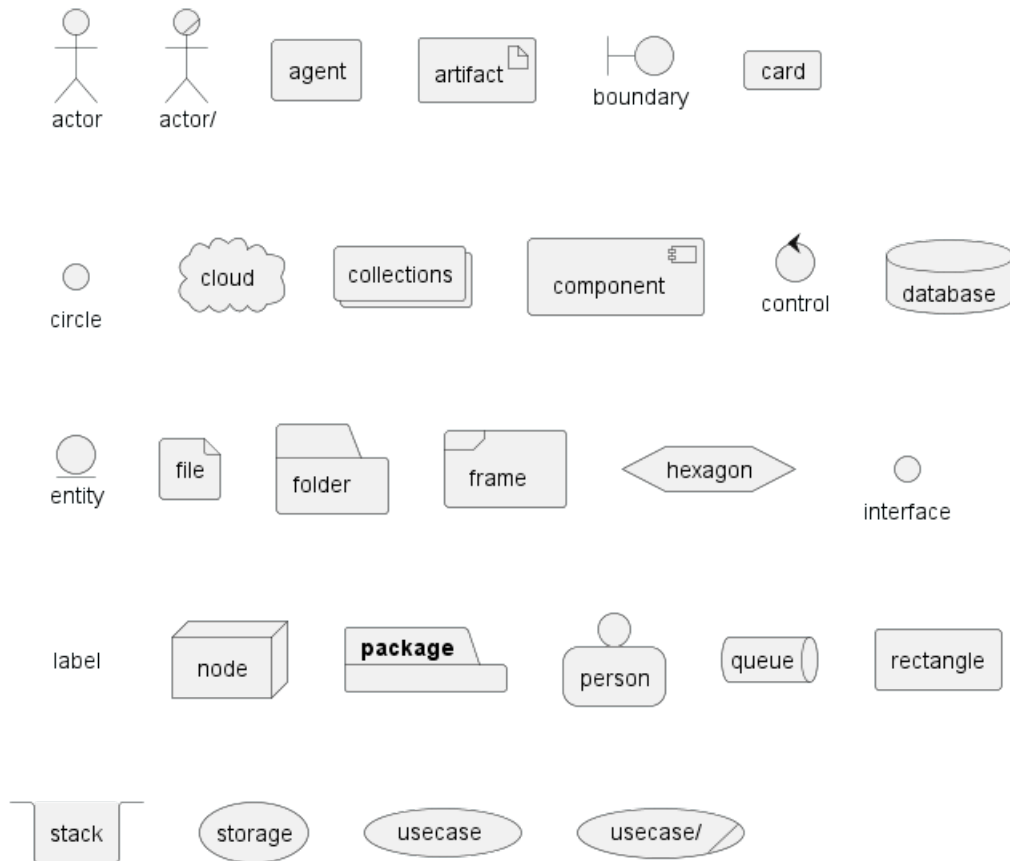

Vous pouvez éventuellement mettre du texte en utilisant les crochets [] pour une longue description.

```

@startuml
folder folder [
This is a <b>folder
----
You can use separator
====
of different kind
....
and style
]

node node [
This is a <b>node
----
You can use separator
====
of different kind
....
and style
]

database database [
This is a <b>database
----
You can use separator
====
of different kind
....
and style

```



```

]

usecase usecase [
This is a <b>usecase
----
You can use separator
====
of different kind
....
and style
]

card card [
This is a <b>card
----
You can use separator
====
of different kind
....
and style
<i><color:blue>(add from V1.2020.7)</color></i>
]
@enduml

```

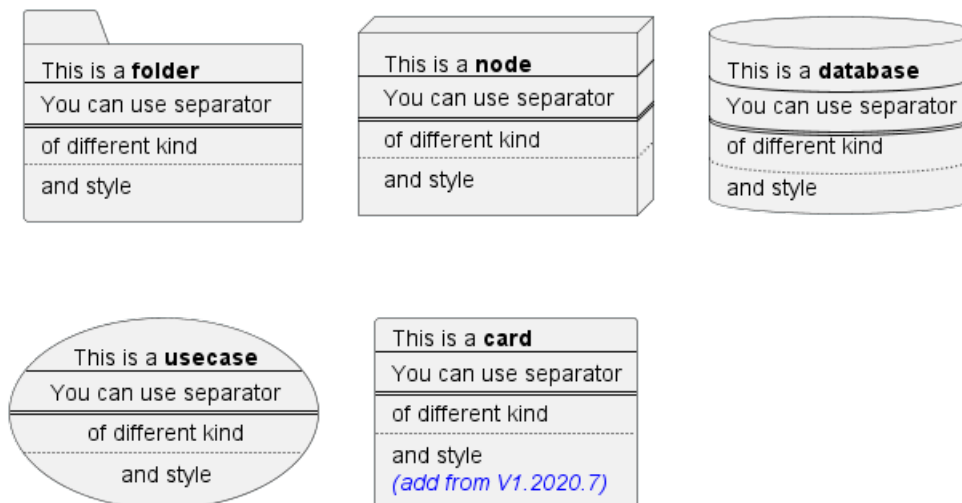

8.2 Declaring element (using short form)

We can declare element using some short forms.

Long form Keyword	Short form Keyword	Long form example	Short form example	Ref.
actor	: a :	actor actor1	:actor2:	Actors
component	[c]	component component1	[component2]	Components
interface	() i	interface interface1	() "interface2"	Interfaces
usecase	(u)	usecase usecase1	(usecase2)	Usecases

8.2.1 Actor

```

@startuml

actor actor1
:actor2:

@enduml

```



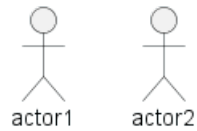

NB: *There is an old syntax for actor with guillemet which is now deprecated and will be removed some days. Please do not use in your diagram.*

8.2.2 Component

```
@startuml
component component1
[component2]
@enduml
```



8.2.3 Interface

```
@startuml
interface interface1
() "interface2"
label "//interface example//"
@enduml
```



interface example

8.2.4 Usecase

```
@startuml
usecase usecase1
(usecase2)
@enduml
```



8.3 Linking or arrow

You can create simple links between elements with or without labels:

```
@startuml
node node1
node node2
node node3
node node4
```



```

node node5
node1 -- node2 : label1
node1 .. node3 : label2
node1 ~~ node4 : label3
node1 == node5

@enduml

```

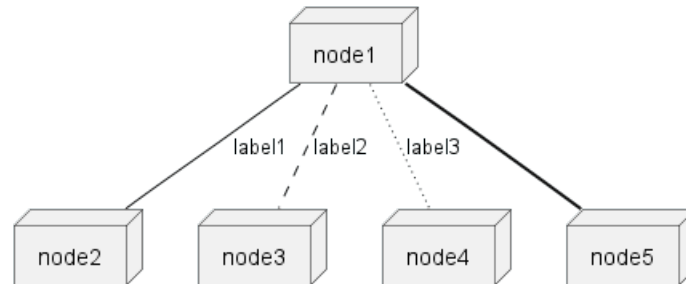

It is possible to use several types of links:

```

@startuml

artifact artifact1
artifact artifact2
artifact artifact3
artifact artifact4
artifact artifact5
artifact artifact6
artifact artifact7
artifact artifact8
artifact artifact9
artifact artifact10

artifact1 --> artifact2
artifact1 --* artifact3
artifact1 --o artifact4
artifact1 --+ artifact5
artifact1 --# artifact6
artifact1 -->> artifact7
artifact1 --0 artifact8
artifact1 --^ artifact9
artifact1 --(0 artifact10

@enduml

```

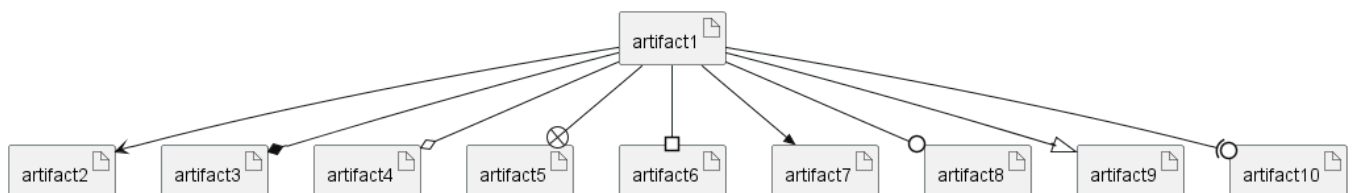

You can also have the following types:

```

@startuml

cloud cloud1
cloud cloud2
cloud cloud3
cloud cloud4

@enduml

```



```

cloud cloud5
cloud1 -0- cloud2
cloud1 -0)- cloud3
cloud1 -(0- cloud4
cloud1 -(0)- cloud5

@enduml

```

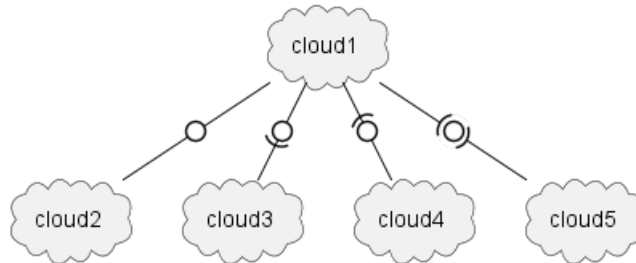

or another example:

```

@startuml
actor foo1
actor foo2
foo1 <-0-> foo2
foo1 <-(0)-> foo2

(ac1) -le(0)-> left1
ac1 -ri(0)-> right1
ac1 .up(0).> up1
ac1 ~up(0)~> up2
ac1 -do(0)-> down1
ac1 -do(0)-> down2

actor1 -0)- actor2

component comp1
component comp2
comp1 *-0)-+ comp2
[comp3] <-->> [comp4]

boundary b1
control c1
b1 -(0)- c1

component comp1
interface interf1
comp1 #~~( interf1

:modelactor: -0)- fooa1
:modelactor1: -ri0)- foo11

[component1] 0)-(0-(0 [componentC]
() component3 )-0-(0 "foo" [componentC]

[aze1] #-->> [aze2]
@enduml

```

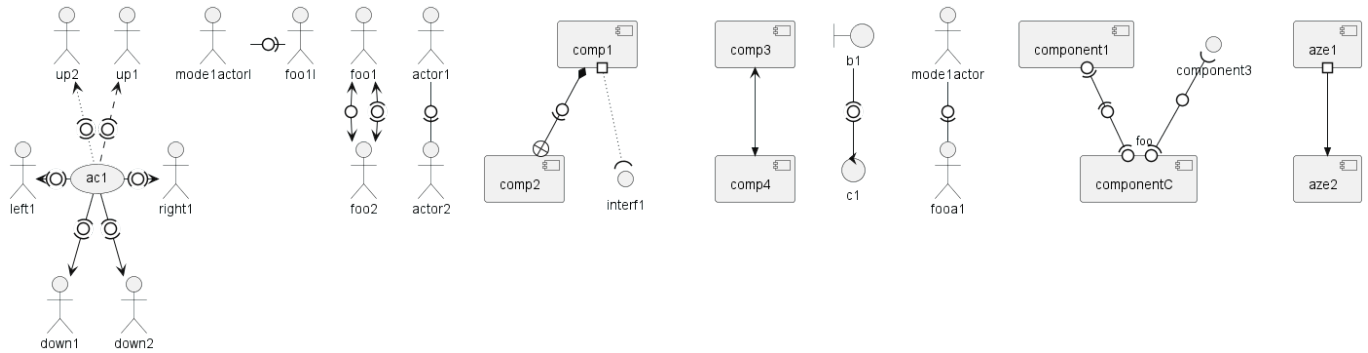

[Ref. QA-547 and QA-1736]

See all type on **Appendix**.

8.4 Bracketed arrow style

Similar as Bracketed **class** relations (linking or arrow) style

8.4.1 Line style

It's also possible to have explicitly bold, dashed, dotted, hidden or plain arrows:

- without label

```
@startuml
node foo
title Bracketed line style without label
foo --> bar
foo -[bold]-> bar1
foo -[dashed]-> bar2
foo -[dotted]-> bar3
foo -[hidden]-> bar4
foo -[plain]-> bar5
@enduml
```

Bracketed line style without label

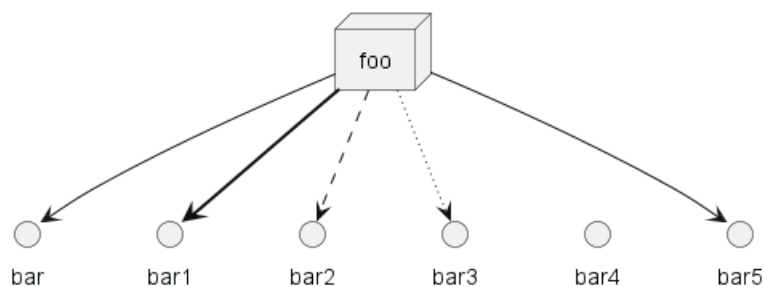

- with label

```
@startuml
title Bracketed line style with label
node foo
foo --> bar :
foo -[bold]-> bar1 : [bold]
foo -[dashed]-> bar2 : [dashed]
foo -[dotted]-> bar3 : [dotted]
foo -[hidden]-> bar4 : [hidden]
foo -[plain]-> bar5 : [plain]
@enduml
```



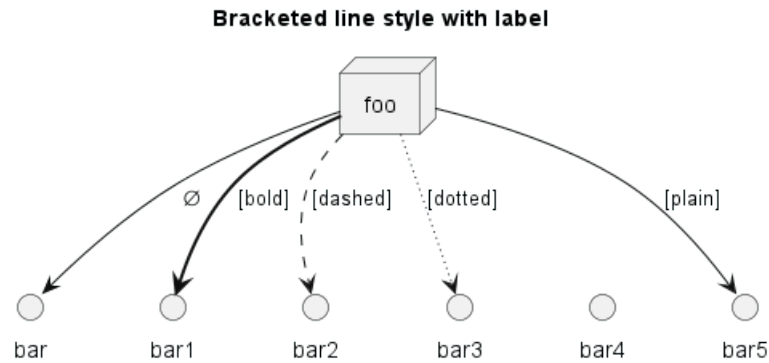

[Adapted from QA-4181]

8.4.2 Line color

```
@startuml
title Bracketed line color
node foo
foo --> bar
foo -[#red]-> bar1 : [#red]
foo -[#green]-> bar2 : [#green]
foo -[#blue]-> bar3 : [#blue]
foo -[#blue;#yellow;#green]-> bar4
@enduml
```

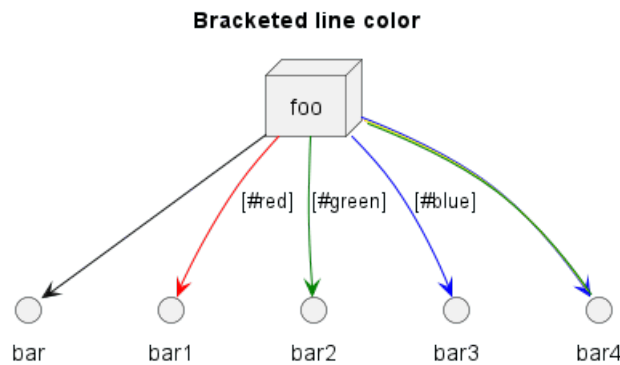

8.4.3 Line thickness

```
@startuml
title Bracketed line thickness
node foo
foo --> bar :
foo -[thickness=1]-> bar1 : [1]
foo -[thickness=2]-> bar2 : [2]
foo -[thickness=4]-> bar3 : [4]
foo -[thickness=8]-> bar4 : [8]
foo -[thickness=16]-> bar5 : [16]
@enduml
```



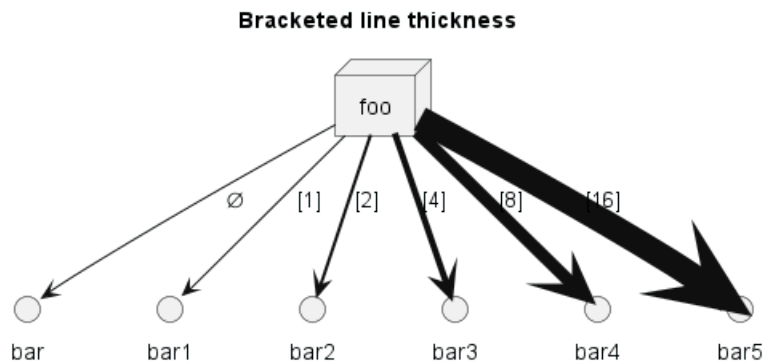

[Adapted from QA-4949]

8.4.4 Mix

```
@startuml
title Bracketed line style mix
node foo
foo --> bar : 
foo -[#red,thickness=1]-> bar1 : [#red,1]
foo -[#red,dashed,thickness=2]-> bar2 : [#red,dashed,2]
foo -[#green,dashed,thickness=4]-> bar3 : [#green,dashed,4]
foo -[#blue,dotted,thickness=8]-> bar4 : [blue,dotted,8]
foo -[#blue,plain,thickness=16]-> bar5 : [blue,plain,16]
foo -[#blue;#green,dashed,thickness=4]-> bar6 : [blue;green,dashed,4]
@enduml
```

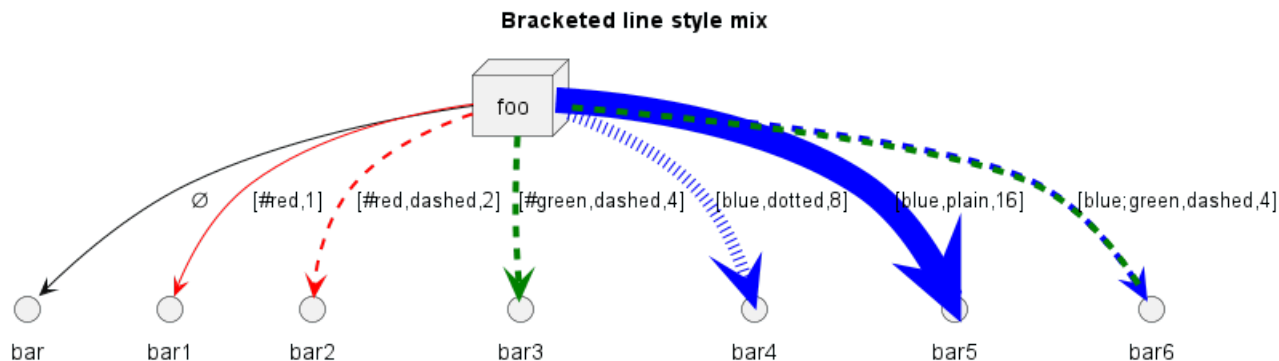

8.5 Change arrow color and style (inline style)

You can change the color or style of individual arrows using the inline following notation:

- #color;line.[bold|dashed|dotted];text:color

```
@startuml
node foo
foo --> bar : normal
foo --> bar1 #line:red;line.bold;text:red : red bold
foo --> bar2 #green;line.dashed;text:green : green dashed
foo --> bar3 #blue;line.dotted;text:blue : blue dotted
@enduml
```



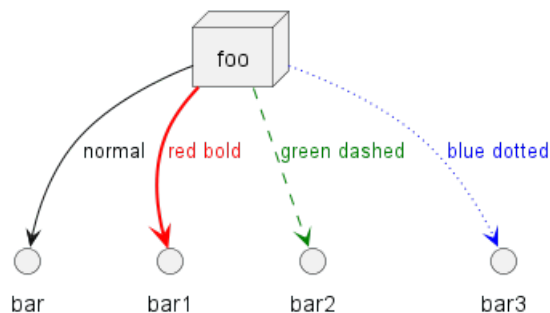

[Ref. QA-3770 and QA-3816] [See similar feature on class diagram]

8.6 Change element color and style (inline style)

You can change the color or style of individual element using the following notation:

- `#[color|back:color];line:color;line.[bold|dashed|dotted];text:color`

```
@startuml
agent a
cloud c #pink;line:red;line.bold;text:red
file f #palegreen;line:green;line.dashed;text:green
node n #aliceblue;line:blue;line.dotted;text:blue
@enduml
```

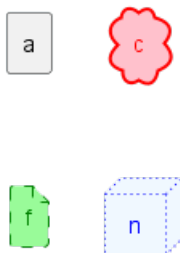

```
@startuml
agent a
cloud c #pink;line:red;line.bold;text:red [
c
cloud description
]
file f #palegreen;line:green;line.dashed;text:green {
[c1]
[c2]
}
frame frame {
node n #aliceblue;line:blue;line.dotted;text:blue
}
@enduml
```

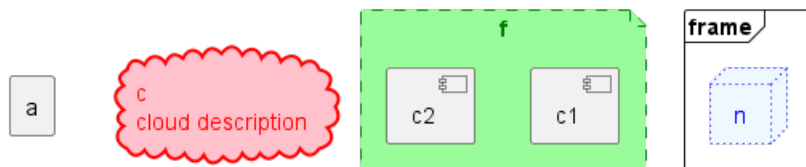

[Ref. QA-6852]



8.7 Nestable elements

Here are the nestable elements:

```
@startuml
artifact artifact {
}
card card {
}
cloud cloud {
}
component component {
}
database database {
}
file file {
}
folder folder {
}
frame frame {
}
hexagon hexagon {
}
node node {
}
package package {
}
queue queue {
}
rectangle rectangle {
}
stack stack {
}
storage storage {
}
@enduml
```



8.8 Packages and nested elements

8.8.1 Example with one level

```
@startuml
artifact      artifactVeryL00000000000000000000g    as "artifact" {
file f1
}
card         cardVeryL00000000000000000000g      as "card" {
file f2
}
cloud       cloudVeryL00000000000000000000g     as "cloud" {
file f3
}
component   componentVeryL00000000000000000000g as "component" {
file f4
}
database    databaseVeryL00000000000000000000g  as "database" {
file f5
}
```



```

}
file      fileVeryL0000000000000000000g      as "file" {
file f6
}
folder    folderVeryL0000000000000000000g    as "folder" {
file f7
}
frame     frameVeryL0000000000000000000g     as "frame" {
file f8
}
hexagon   hexagonVeryL0000000000000000000g   as "hexagon" {
file f9
}
node      nodeVeryL0000000000000000000g      as "node" {
file f10
}
package   packageVeryL0000000000000000000g   as "package" {
file f11
}
queue     queueVeryL0000000000000000000g     as "queue" {
file f12
}
rectangle rectangleVeryL0000000000000000000g as "rectangle" {
file f13
}
stack     stackVeryL0000000000000000000g     as "stack" {
file f14
}
storage   storageVeryL0000000000000000000g   as "storage" {
file f15
}
@enduml

```

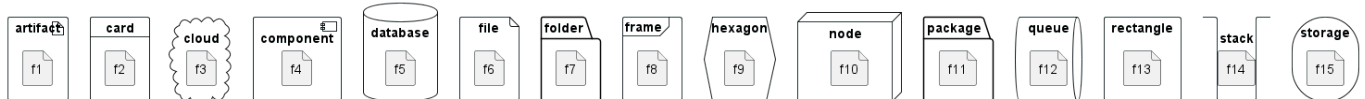

8.8.2 Other example

```

@startuml
artifact Foo1 {
  folder Foo2
}

folder Foo3 {
  artifact Foo4
}

frame Foo5 {
  database Foo6
}

cloud vpc {
  node ec2 {
    stack stack
  }
}

```



```
@enduml
```

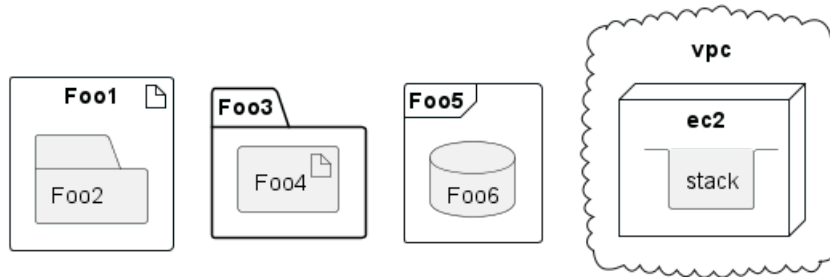

```
@startuml
node Foo1 {
  cloud Foo2
}

cloud Foo3 {
  frame Foo4
}

database Foo5 {
  storage Foo6
}

storage Foo7 {
  storage Foo8
}
@enduml
```

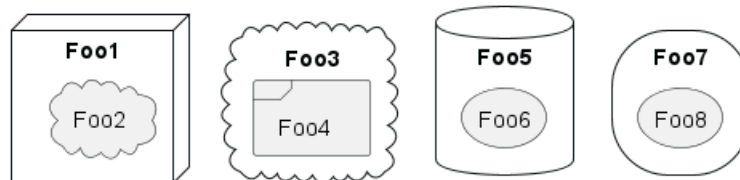

8.8.3 Full nesting

Here is all the nested elements:

- by alphabetical order:

```
@startuml
artifact artifact {
card card {
cloud cloud {
component component {
database database {
file file {
folder folder {
frame frame {
hexagon hexagon {
node node {
package package {
queue queue {
rectangle rectangle {
stack stack {
storage storage {
```



```
}  
}  
}  
}  
}  
}  
}  
}  
}  
}  
}  
}  
}  
}  
}  
}  
}  
}  
}  
}  
}  
@enduml
```

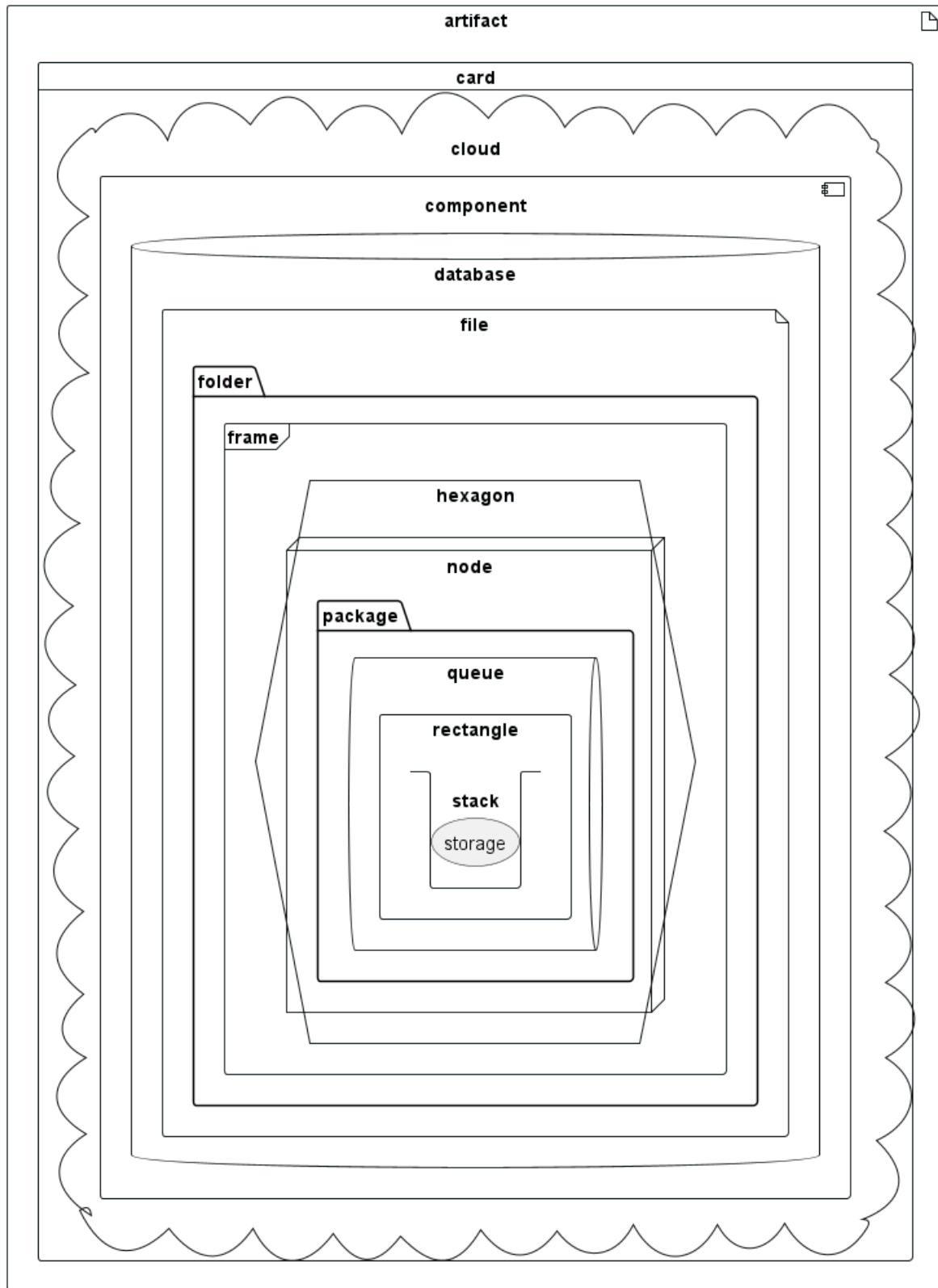

- or reverse alphabetical order

```

@startuml
storage storage {
stack stack {
rectangle rectangle {
queue queue {
package package {

```

```
node node {  
  hexagon hexagon {  
    frame frame {  
      folder folder {  
        file file {  
          database database {  
            component component {  
              cloud cloud {  
                card card {  
                  artifact artifact {  
                }  
              }  
            }  
          }  
        }  
      }  
    }  
  }  
}  
@enduml
```

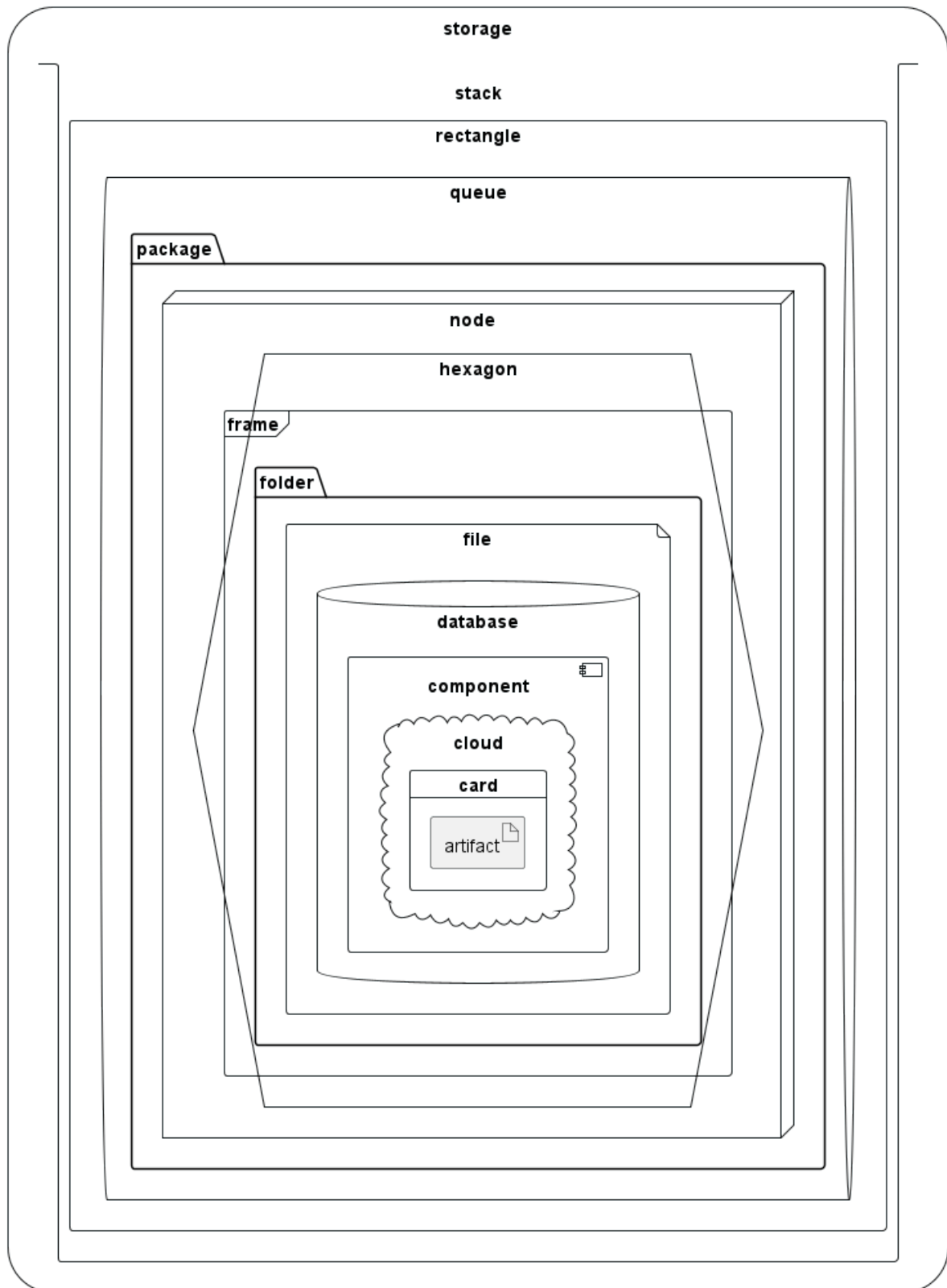
8.9 Alias

8.9.1 Simple alias with as

```
@startuml
node Node1 as n1
node "Node 2" as n2
```



```

file f1 as "File 1"
cloud c1 as "this
is
a
cloud"
cloud c2 [this
is
another
cloud]

n1 -> n2
n1 --> f1
f1 -> c1
c1 -> c2
@enduml

```

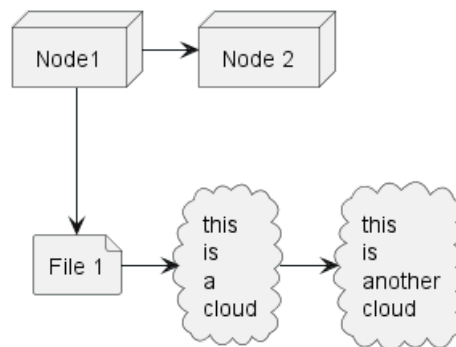

8.9.2 Examples of long alias

```

@startuml
actor      "actor"      as actorVeryL0000000000000000000g
agent      "agent"      as agentVeryL0000000000000000000g
artifact   "artifact"   as artifactVeryL0000000000000000000g
boundary   "boundary"   as boundaryVeryL0000000000000000000g
card        "card"       as cardVeryL0000000000000000000g
cloud      "cloud"       as cloudVeryL0000000000000000000g
collections "collections" as collectionsVeryL0000000000000000000g
component  "component"  as componentVeryL0000000000000000000g
control     "control"    as controlVeryL0000000000000000000g
database    "database"   as databaseVeryL0000000000000000000g
entity     "entity"     as entityVeryL0000000000000000000g
file        "file"       as fileVeryL0000000000000000000g
folder      "folder"     as folderVeryL0000000000000000000g
frame       "frame"      as frameVeryL0000000000000000000g
hexagon     "hexagon"    as hexagonVeryL0000000000000000000g
interface   "interface"  as interfaceVeryL0000000000000000000g
label       "label"      as labelVeryL0000000000000000000g
node        "node"       as nodeVeryL0000000000000000000g
package     "package"    as packageVeryL0000000000000000000g
person      "person"     as personVeryL0000000000000000000g
queue       "queue"      as queueVeryL0000000000000000000g
stack       "stack"      as stackVeryL0000000000000000000g
rectangle   "rectangle"  as rectangleVeryL0000000000000000000g
storage     "storage"    as storageVeryL0000000000000000000g
usecase     "usecase"    as usecaseVeryL0000000000000000000g
@enduml

```

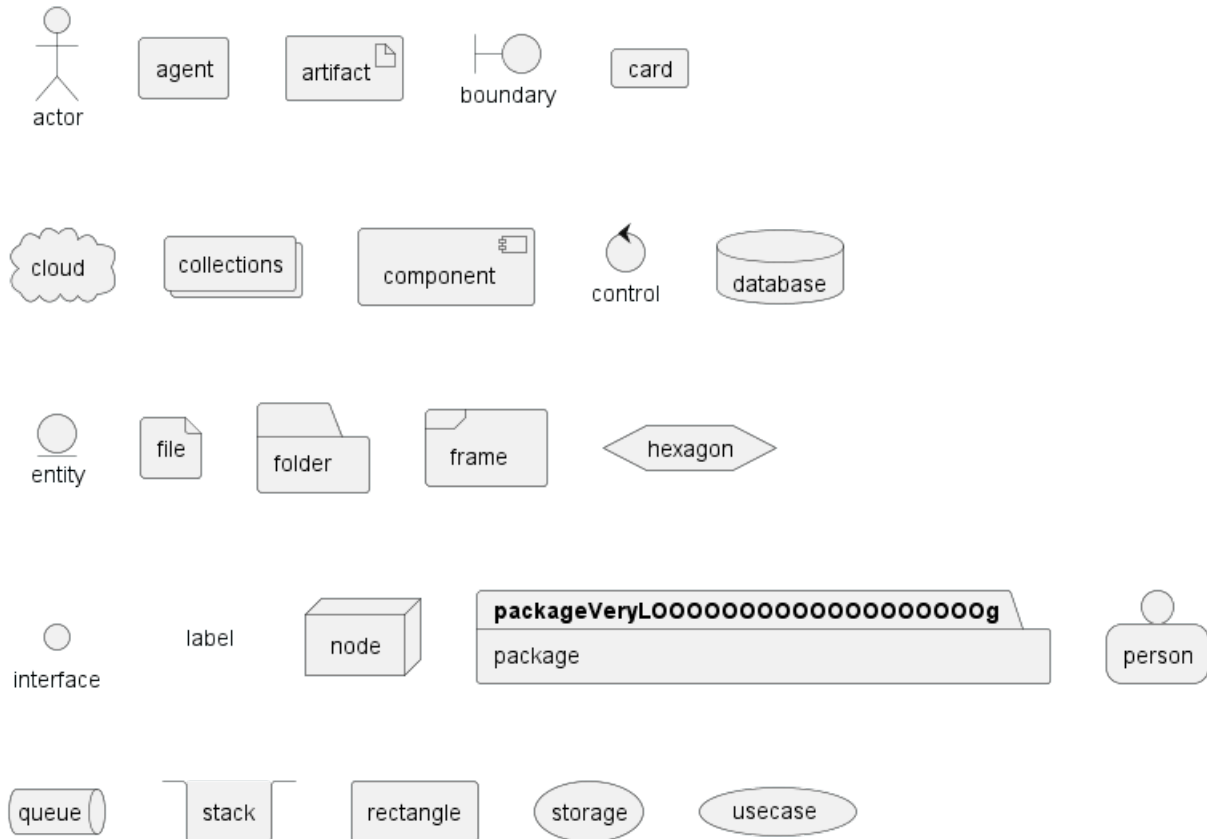

```

@startuml
actor      actorVeryL00000000000000000000g      as "actor"
agent      agentVeryL00000000000000000000g      as "agent"
artifact   artifactVeryL00000000000000000000g  as "artifact"
boundary   boundaryVeryL00000000000000000000g  as "boundary"
card       cardVeryL00000000000000000000g      as "card"
cloud      cloudVeryL00000000000000000000g     as "cloud"
collections collectionsVeryL00000000000000000000g as "collections"
component  componentVeryL00000000000000000000g as "component"
control    controlVeryL00000000000000000000g   as "control"
database   databaseVeryL00000000000000000000g  as "database"
entity     entityVeryL00000000000000000000g    as "entity"
file       fileVeryL00000000000000000000g      as "file"
folder     folderVeryL00000000000000000000g    as "folder"
frame      frameVeryL00000000000000000000g     as "frame"
hexagon    hexagonVeryL00000000000000000000g   as "hexagon"
interface  interfaceVeryL00000000000000000000g as "interface"
label      labelVeryL00000000000000000000g    as "label"
node       nodeVeryL00000000000000000000g      as "node"
package    packageVeryL00000000000000000000g   as "package"
person     personVeryL00000000000000000000g    as "person"
queue      queueVeryL00000000000000000000g     as "queue"
stack      stackVeryL00000000000000000000g     as "stack"
rectangle  rectangleVeryL00000000000000000000g as "rectangle"
storage    storageVeryL00000000000000000000g   as "storage"
usecase    usecaseVeryL00000000000000000000g   as "usecase"
@enduml

```



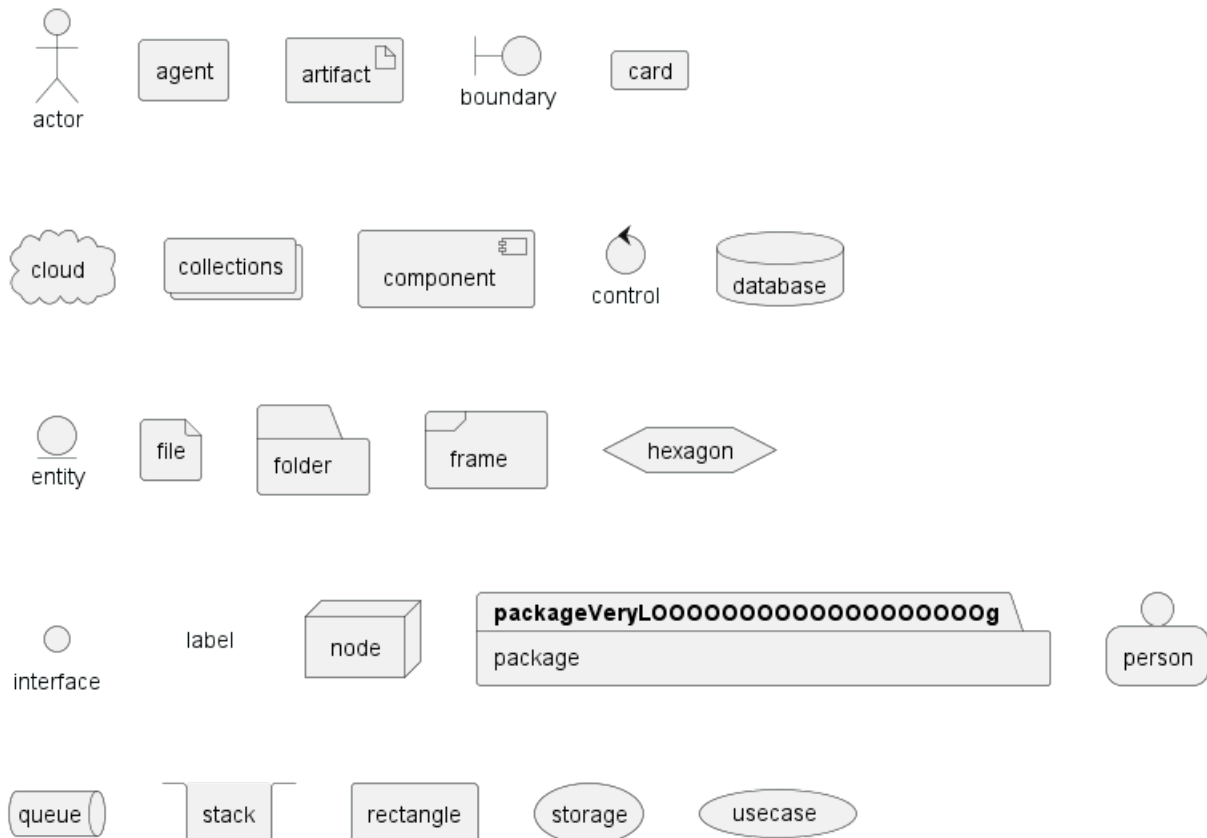

[Ref. QA-12082]

8.10 Round corner

```

@startuml
skinparam rectangle {
    roundCorner<<Concept>> 25
}

rectangle "Concept Model" <<Concept>> {
    rectangle "Example 1" <<Concept>> as ex1
    rectangle "Another rectangle"
}
@enduml

```

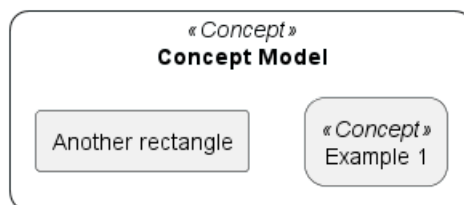

8.11 Specific SkinParameter

8.11.1 roundCorner

```

@startuml
skinparam roundCorner 15
actor actor
agent agent
artifact artifact

```



```

boundary boundary
card card
circle circle
cloud cloud
collections collections
component component
control control
database database
entity entity
file file
folder folder
frame frame
hexagon hexagon
interface interface
label label
node node
package package
person person
queue queue
rectangle rectangle
stack stack
storage storage
usecase usecase
@enduml

```

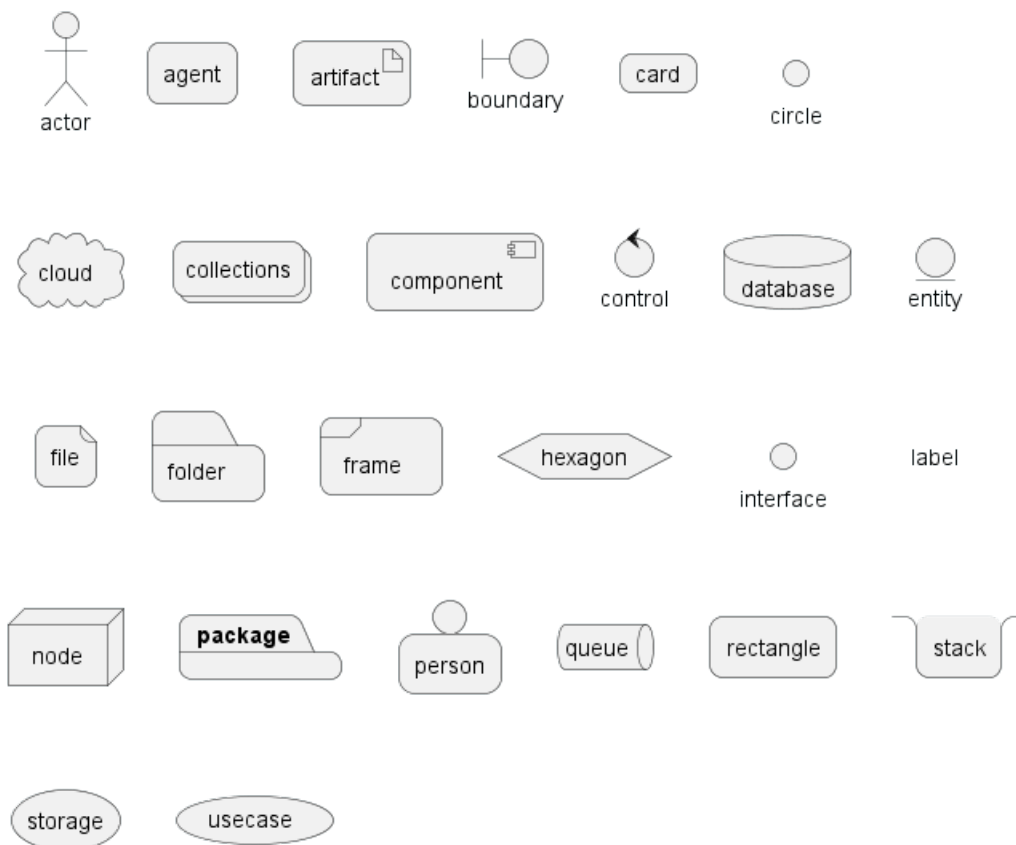

[Ref. QA-5299, QA-6915, QA-11943]

8.12 Appendix: All type of arrow line

```

@startuml
left to right direction
skinparam nodesep 5

```



```
f3 ~~ b3 : ""~~""\n//dotted//
f2 .. b2 : ""..""\n//dashed//
f1 == b1 : ""==""\n//bold//
f0 -- b0 : ""--""\n//plain//
@enduml
```

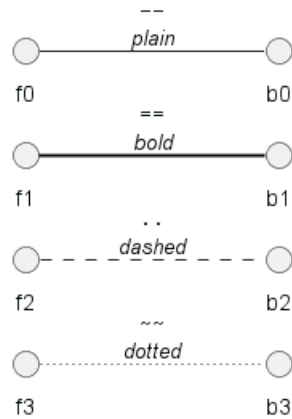

8.13 Appendix: All type of arrow head or '0' arrow

8.13.1 Type of arrow head

```
@startuml
left to right direction
skinparam nodesep 5

f13 --0 b13 : ""--0""
f12 --@ b12 : ""--@""
f11 --:|> b11 : ""--:|>""
f10 --||> b10 : ""--||>""
f9 --|> b9 : ""--|>""
f8 --^ b8 : ""--^ ""
f7 --\\ b7 : ""--\\\\"""
f6 --# b6 : ""--# ""
f5 --+ b5 : ""--+ ""
f4 --o b4 : ""--o ""
f3 --* b3 : ""--* ""
f2 -->> b2 : ""-->>""
f1 --> b1 : ""--> ""
f0 -- b0 : ""-- ""
@enduml
```

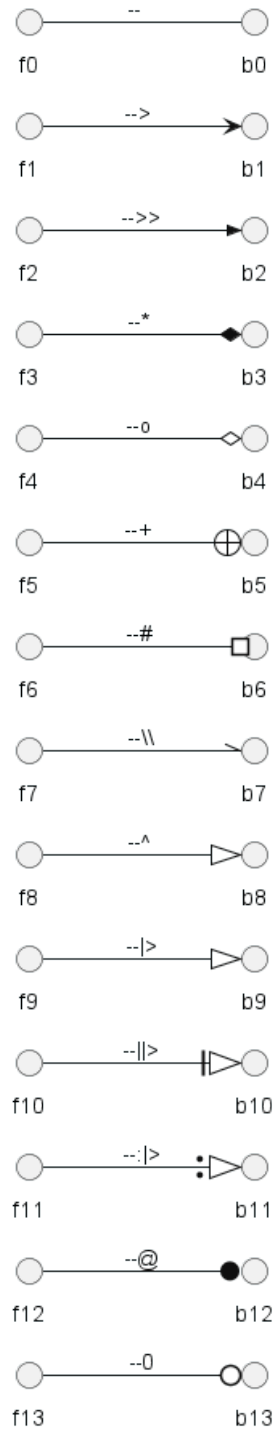

8.13.2 Type of '0' arrow or circle arrow

```

@startuml
left to right direction
skinparam nodesep 5

f10 0--0 b10 : "" 0--0 ""
f9 )--( b9 : "" )--( ""
f8 0)--(0 b8 : "" 0)--(0""
f7 0)-- b7 : "" 0)-- ""
f6 -0)- b6 : "" -0)- ""
f5 -(0)- b5 : "" -(0)-""

```



```
f4 -(0- b4 : "" -(0- ""
f3 --(0 b3 : "" --(0 ""
f2 --( b2 : "" --( ""
f1 --0 b1 : "" --0 ""
@enduml
```

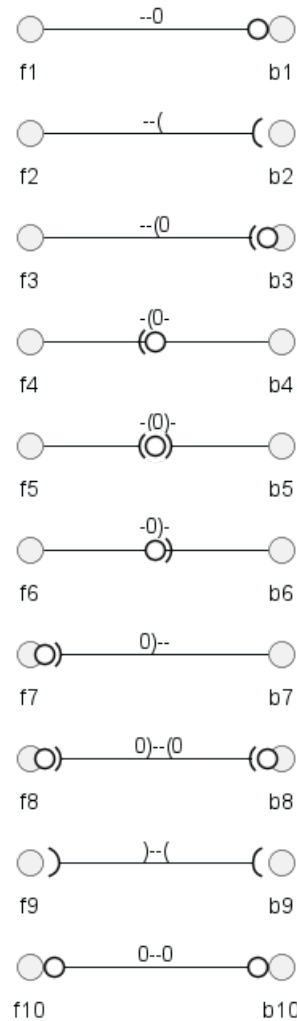

8.14 Appendix: Test of inline style on all element

8.14.1 Simple element

```
@startuml
actor actor #aliceblue;line:blue;line.dotted;text:blue
actor/ "actor/" #aliceblue;line:blue;line.dotted;text:blue
agent agent #aliceblue;line:blue;line.dotted;text:blue
artifact artifact #aliceblue;line:blue;line.dotted;text:blue
boundary boundary #aliceblue;line:blue;line.dotted;text:blue
card card #aliceblue;line:blue;line.dotted;text:blue
circle circle #aliceblue;line:blue;line.dotted;text:blue
cloud cloud #aliceblue;line:blue;line.dotted;text:blue
collections collections #aliceblue;line:blue;line.dotted;text:blue
component component #aliceblue;line:blue;line.dotted;text:blue
control control #aliceblue;line:blue;line.dotted;text:blue
database database #aliceblue;line:blue;line.dotted;text:blue
entity entity #aliceblue;line:blue;line.dotted;text:blue
file file #aliceblue;line:blue;line.dotted;text:blue
folder folder #aliceblue;line:blue;line.dotted;text:blue
```



```

frame frame #aliceblue;line:blue;line.dotted;text:blue
hexagon hexagon #aliceblue;line:blue;line.dotted;text:blue
interface interface #aliceblue;line:blue;line.dotted;text:blue
label label #aliceblue;line:blue;line.dotted;text:blue
node node #aliceblue;line:blue;line.dotted;text:blue
package package #aliceblue;line:blue;line.dotted;text:blue
person person #aliceblue;line:blue;line.dotted;text:blue
queue queue #aliceblue;line:blue;line.dotted;text:blue
rectangle rectangle #aliceblue;line:blue;line.dotted;text:blue
stack stack #aliceblue;line:blue;line.dotted;text:blue
storage storage #aliceblue;line:blue;line.dotted;text:blue
usecase usecase #aliceblue;line:blue;line.dotted;text:blue
usecase/ "usecase/" #aliceblue;line:blue;line.dotted;text:blue
@enduml

```

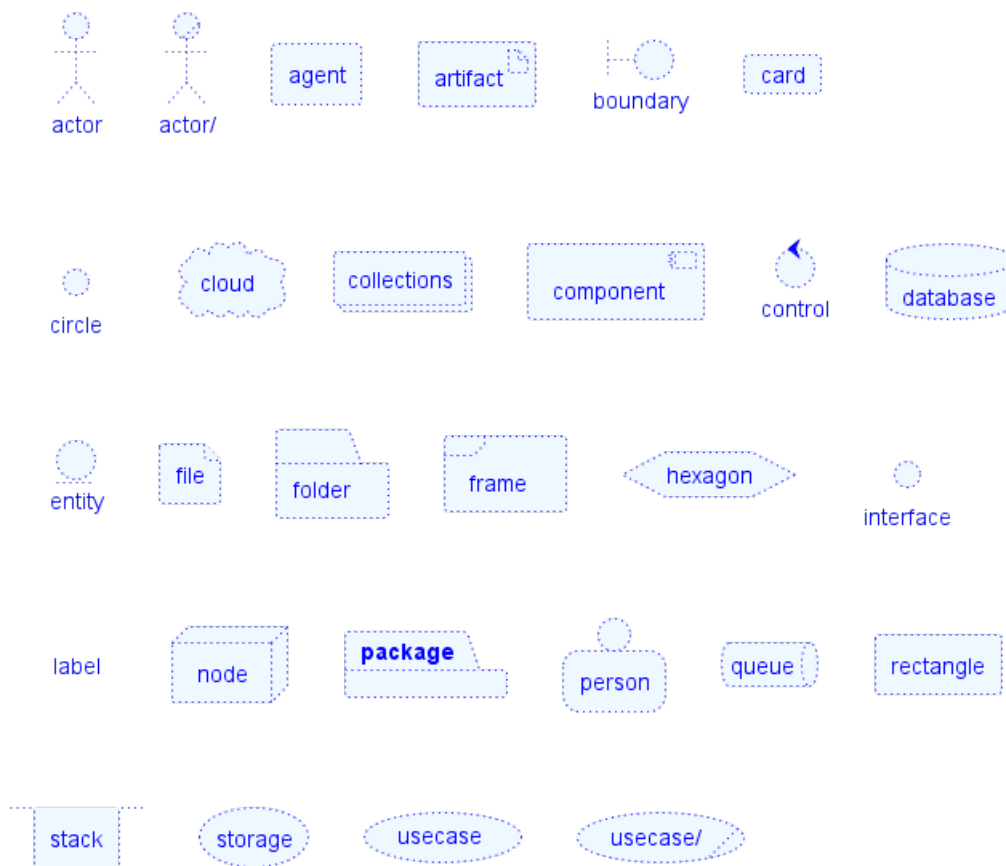

8.14.2 Nested element

8.14.3 Without sub-element

```

@startuml
artifact artifact #aliceblue;line:blue;line.dotted;text:blue {
}
card card #aliceblue;line:blue;line.dotted;text:blue {
}
cloud cloud #aliceblue;line:blue;line.dotted;text:blue {
}
component component #aliceblue;line:blue;line.dotted;text:blue {
}
database database #aliceblue;line:blue;line.dotted;text:blue {
}
file file #aliceblue;line:blue;line.dotted;text:blue {
}

```



```

}
folder folder #aliceblue;line:blue;line.dotted;text:blue {
}
frame frame #aliceblue;line:blue;line.dotted;text:blue {
}
hexagon hexagon #aliceblue;line:blue;line.dotted;text:blue {
}
node node #aliceblue;line:blue;line.dotted;text:blue {
}
package package #aliceblue;line:blue;line.dotted;text:blue {
}
queue queue #aliceblue;line:blue;line.dotted;text:blue {
}
rectangle rectangle #aliceblue;line:blue;line.dotted;text:blue {
}
stack stack #aliceblue;line:blue;line.dotted;text:blue {
}
storage storage #aliceblue;line:blue;line.dotted;text:blue {
}
@enduml

```



8.14.4 With sub-element

```

@startuml
artifact      artifactVeryL00000000000000000000g      as "artifact" #aliceblue;line:blue;line.dotted;text:
file f1
}
card         cardVeryL00000000000000000000g         as "card" #aliceblue;line:blue;line.dotted;text:blu
file f2
}
cloud       cloudVeryL00000000000000000000g       as "cloud" #aliceblue;line:blue;line.dotted;text:bl
file f3
}
component   componentVeryL00000000000000000000g   as "component" #aliceblue;line:blue;line.dotted;text:
file f4
}
database    databaseVeryL00000000000000000000g    as "database" #aliceblue;line:blue;line.dotted;text:
file f5
}
file       fileVeryL00000000000000000000g        as "file" #aliceblue;line:blue;line.dotted;text:blu
file f6
}
folder     folderVeryL00000000000000000000g      as "folder" #aliceblue;line:blue;line.dotted;text:b
file f7
}
frame      frameVeryL00000000000000000000g       as "frame" #aliceblue;line:blue;line.dotted;text:bl
file f8
}
hexagon    hexagonVeryL00000000000000000000g     as "hexagon" #aliceblue;line:blue;line.dotted;text:l
file f9
}
node       nodeVeryL00000000000000000000g        as "node" #aliceblue;line:blue;line.dotted;text:blu
file f10
}
package    packageVeryL00000000000000000000g     as "package" #aliceblue;line:blue;line.dotted;text:l

```



```

file f11
}
queue      queueVeryL0000000000000000000g      as "queue" #aliceblue;line:blue;line.dotted;text:bl
file f12
}
rectangle  rectangleVeryL0000000000000000000g  as "rectangle" #aliceblue;line:blue;line.dotted;text:
file f13
}
stack      stackVeryL00000000000000000000g    as "stack" #aliceblue;line:blue;line.dotted;text:bl
file f14
}
storage    storageVeryL0000000000000000000g   as "storage" #aliceblue;line:blue;line.dotted;text:
file f15
}
@enduml

```

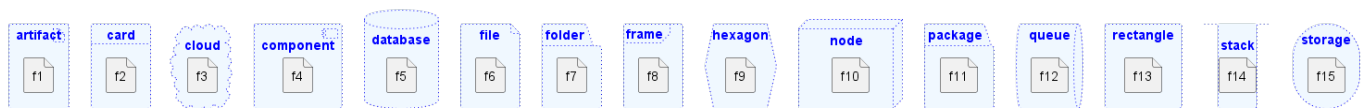

8.15 Appendix: Test of style on all element

8.15.1 Simple element

8.15.2 Global style (on componentDiagram)

```

@startuml
<style>
componentDiagram {
  BackGroundColor palegreen
  LineThickness 1
  LineColor red
}
document {
  BackGroundColor white
}
</style>
actor actor
actor/ "actor/"
agent agent
artifact artifact
boundary boundary
card card
circle circle
cloud cloud
collections collections
component component
control control
database database
entity entity
file file
folder folder
frame frame
hexagon hexagon
interface interface
label label
node node
package package

```



```

person person
queue queue
rectangle rectangle
stack stack
storage storage
usecase usecase
usecase/ "usecase/"
@enduml

```

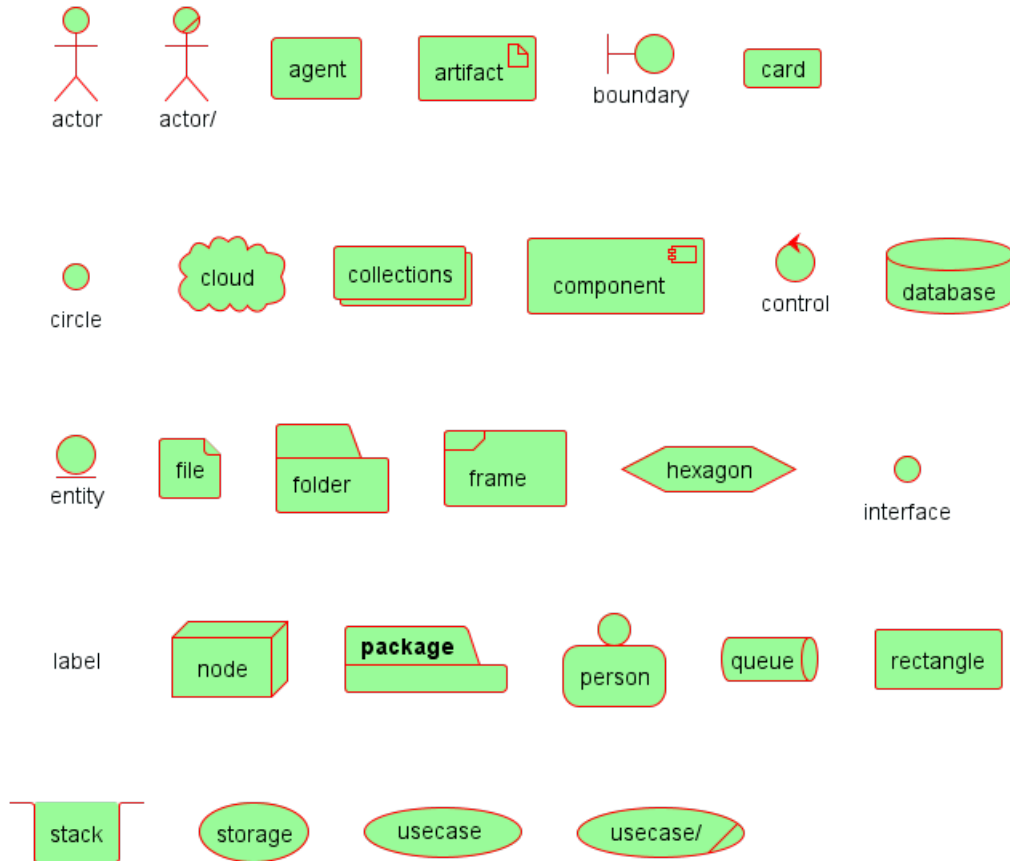

8.15.3 Style for each element

```

@startuml
<style>
actor {
  BackGroundColor #f80c12
  LineThickness 1
  LineColor black
}
agent {
  BackGroundColor #f80c12
  LineThickness 1
  LineColor black
}
artifact {
  BackGroundColor #ee1100
  LineThickness 1
  LineColor black
}
boundary {
  BackGroundColor #ee1100
  LineThickness 1
}

```



```
    LineColor black
  }
  card {
    BackGroundColor #ff3311
    LineThickness 1
    LineColor black
  }
  circle {
    BackGroundColor #ff3311
    LineThickness 1
    LineColor black
  }
  cloud {
    BackGroundColor #ff4422
    LineThickness 1
    LineColor black
  }
  collections {
    BackGroundColor #ff4422
    LineThickness 1
    LineColor black
  }
  component {
    BackGroundColor #ff6644
    LineThickness 1
    LineColor black
  }
  control {
    BackGroundColor #ff6644
    LineThickness 1
    LineColor black
  }
  database {
    BackGroundColor #ff9933
    LineThickness 1
    LineColor black
  }
  entity {
    BackGroundColor #feae2d
    LineThickness 1
    LineColor black
  }
  file {
    BackGroundColor #feae2d
    LineThickness 1
    LineColor black
  }
  folder {
    BackGroundColor #ccbb33
    LineThickness 1
    LineColor black
  }
  frame {
    BackGroundColor #d0c310
    LineThickness 1
    LineColor black
  }
  hexagon {
```



```
    BackGroundColor #aacc22
    LineThickness 1
    LineColor black
}
interface {
    BackGroundColor #69d025
    LineThickness 1
    LineColor black
}
label {
    BackGroundColor black
    LineThickness 1
    LineColor black
}
node {
    BackGroundColor #22ccaa
    LineThickness 1
    LineColor black
}
package {
    BackGroundColor #12bdb9
    LineThickness 1
    LineColor black
}
person {
    BackGroundColor #11aabb
    LineThickness 1
    LineColor black
}
queue {
    BackGroundColor #11aabb
    LineThickness 1
    LineColor black
}
rectangle {
    BackGroundColor #4444dd
    LineThickness 1
    LineColor black
}
stack {
    BackGroundColor #3311bb
    LineThickness 1
    LineColor black
}
storage {
    BackGroundColor #3b0cbd
    LineThickness 1
    LineColor black
}
usecase {
    BackGroundColor #442299
    LineThickness 1
    LineColor black
}
</style>
actor actor
actor/ "actor/"
agent agent
```



```

artifact artifact
boundary boundary
card card
circle circle
cloud cloud
collections collections
component component
control control
database database
entity entity
file file
folder folder
frame frame
hexagon hexagon
interface interface
label label
node node
package package
person person
queue queue
rectangle rectangle
stack stack
storage storage
usecase usecase
usecase/ "usecase/"
@enduml

```

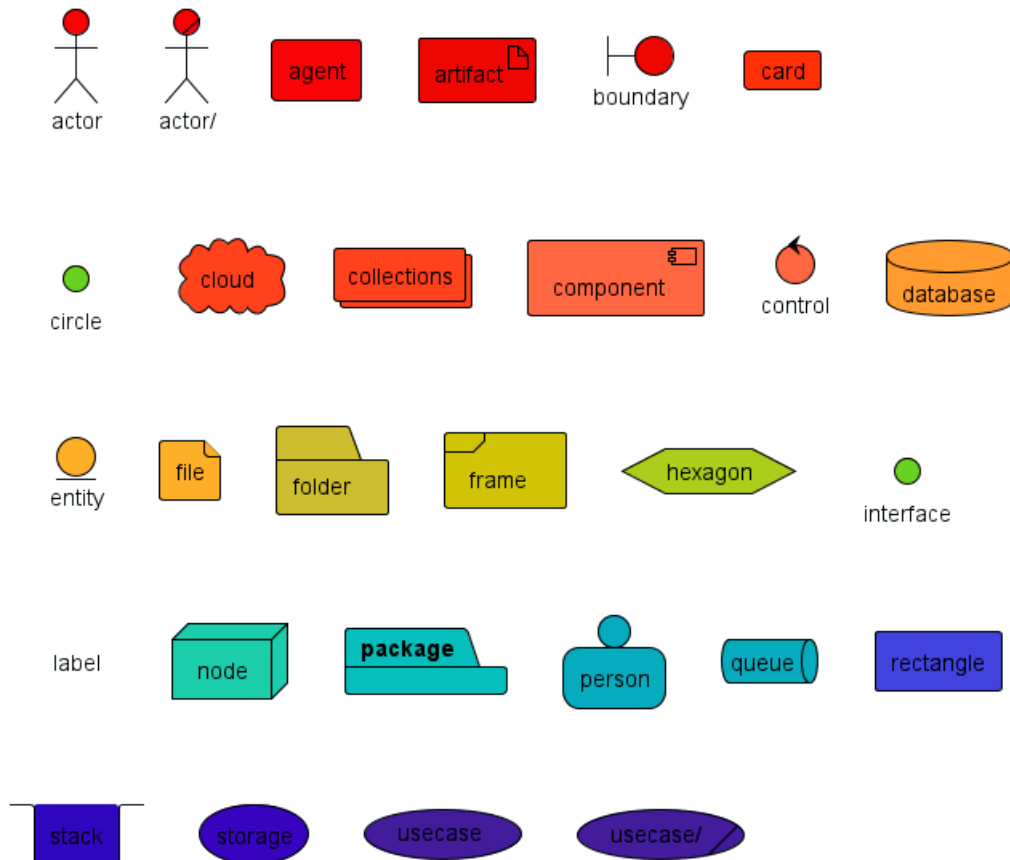

[Ref. QA-13261]



8.15.4 Nested element (without level)

8.15.5 Global style (on componentDiagram)

```

@startuml
<style>
componentDiagram {
  BackGroundColor palegreen
  LineThickness 2
  LineColor red
}
</style>
artifact artifact {
}
card card {
}
cloud cloud {
}
component component {
}
database database {
}
file file {
}
folder folder {
}
frame frame {
}
hexagon hexagon {
}
node node {
}
package package {
}
queue queue {
}
rectangle rectangle {
}
stack stack {
}
storage storage {
}
@enduml

```



8.15.6 Style for each nested element

```

@startuml
<style>
artifact {
  BackGroundColor #ee1100
  LineThickness 1
  LineColor black
}
card {
  BackGroundColor #ff3311
  LineThickness 1
}

```



```
    LineColor black
}
cloud {
    BackGroundColor #ff4422
    LineThickness 1
    LineColor black
}
component {
    BackGroundColor #ff6644
    LineThickness 1
    LineColor black
}
database {
    BackGroundColor #ff9933
    LineThickness 1
    LineColor black
}
file {
    BackGroundColor #feae2d
    LineThickness 1
    LineColor black
}
folder {
    BackGroundColor #ccbb33
    LineThickness 1
    LineColor black
}
frame {
    BackGroundColor #d0c310
    LineThickness 1
    LineColor black
}
hexagon {
    BackGroundColor #aacc22
    LineThickness 1
    LineColor black
}
node {
    BackGroundColor #22ccaa
    LineThickness 1
    LineColor black
}
package {
    BackGroundColor #12bdb9
    LineThickness 1
    LineColor black
}
queue {
    BackGroundColor #11aabb
    LineThickness 1
    LineColor black
}
rectangle {
    BackGroundColor #4444dd
    LineThickness 1
    LineColor black
}
stack {
```



```

    BackGroundColor #3311bb
    LineThickness 1
    LineColor black
}
storage {
    BackGroundColor #3b0cbd
    LineThickness 1
    LineColor black
}

</style>
artifact artifact {
}
card card {
}
cloud cloud {
}
component component {
}
database database {
}
file file {
}
folder folder {
}
frame frame {
}
hexagon hexagon {
}
node node {
}
package package {
}
queue queue {
}
rectangle rectangle {
}
stack stack {
}
storage storage {
}
@enduml

```

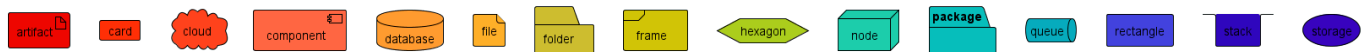

8.15.7 Nested element (with one level)

8.15.8 Global style (on componentDiagram)

```

@startuml
<style>
componentDiagram {
    BackGroundColor palegreen
    LineThickness 1
    LineColor red
}
document {
    BackGroundColor white

```



```

}
</style>
artifact e1 as "artifact" {
file f1
}
card e2 as "card" {
file f2
}
cloud e3 as "cloud" {
file f3
}
component e4 as "component" {
file f4
}
database e5 as "database" {
file f5
}
file e6 as "file" {
file f6
}
folder e7 as "folder" {
file f7
}
frame e8 as "frame" {
file f8
}
hexagon e9 as "hexagon" {
file f9
}
node e10 as "node" {
file f10
}
package e11 as "package" {
file f11
}
queue e12 as "queue" {
file f12
}
rectangle e13 as "rectangle" {
file f13
}
stack e14 as "stack" {
file f14
}
storage e15 as "storage" {
file f15
}
@enduml

```

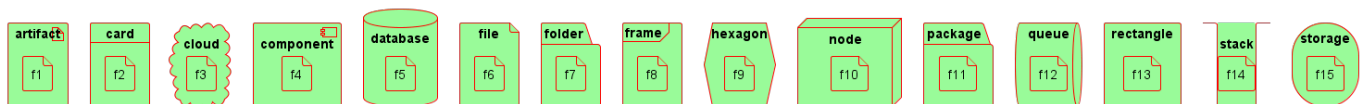

8.15.9 Style for each nested element

```

@startuml
<style>

```



```
artifact {
  BackGroundColor #ee1100
  LineThickness 1
  LineColor black
}
card {
  BackGroundColor #ff3311
  LineThickness 1
  LineColor black
}
cloud {
  BackGroundColor #ff4422
  LineThickness 1
  LineColor black
}
component {
  BackGroundColor #ff6644
  LineThickness 1
  LineColor black
}
database {
  BackGroundColor #ff9933
  LineThickness 1
  LineColor black
}
file {
  BackGroundColor #feae2d
  LineThickness 1
  LineColor black
}
folder {
  BackGroundColor #ccb333
  LineThickness 1
  LineColor black
}
frame {
  BackGroundColor #d0c310
  LineThickness 1
  LineColor black
}
hexagon {
  BackGroundColor #aacc22
  LineThickness 1
  LineColor black
}
node {
  BackGroundColor #22ccaa
  LineThickness 1
  LineColor black
}
package {
  BackGroundColor #12bdb9
  LineThickness 1
  LineColor black
}
queue {
  BackGroundColor #11aabb
  LineThickness 1
}
```



```
    LineColor black
  }
rectangle {
  BackGroundColor #4444dd
  LineThickness 1
  LineColor black
}
stack {
  BackGroundColor #3311bb
  LineThickness 1
  LineColor black
}
storage {
  BackGroundColor #3b0cbd
  LineThickness 1
  LineColor black
}
</style>
artifact e1 as "artifact" {
file f1
}
card e2 as "card" {
file f2
}
cloud e3 as "cloud" {
file f3
}
component e4 as "component" {
file f4
}
database e5 as "database" {
file f5
}
file e6 as "file" {
file f6
}
folder e7 as "folder" {
file f7
}
frame e8 as "frame" {
file f8
}
hexagon e9 as "hexagon" {
file f9
}
node e10 as "node" {
file f10
}
package e11 as "package" {
file f11
}
queue e12 as "queue" {
file f12
}
rectangle e13 as "rectangle" {
file f13
}
stack e14 as "stack" {
```



```

file f14
}
storage e15 as "storage" {
file f15
}
@enduml

```

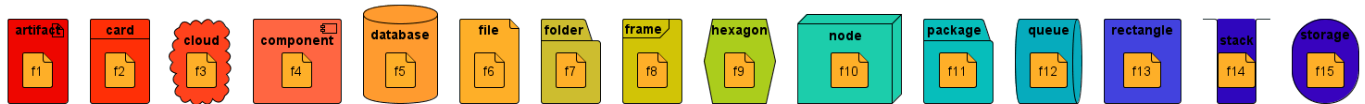

8.16 Appendix: Test of stereotype with style on all element

8.16.1 Simple element

```

@startuml
<style>
.stereo {
  BackgroundColor palegreen
}
</style>
actor actor << stereo >>
actor/ "actor/" << stereo >>
agent agent << stereo >>
artifact artifact << stereo >>
boundary boundary << stereo >>
card card << stereo >>
circle circle << stereo >>
cloud cloud << stereo >>
collections collections << stereo >>
component component << stereo >>
control control << stereo >>
database database << stereo >>
entity entity << stereo >>
file file << stereo >>
folder folder << stereo >>
frame frame << stereo >>
hexagon hexagon << stereo >>
interface interface << stereo >>
label label << stereo >>
node node << stereo >>
package package << stereo >>
person person << stereo >>
queue queue << stereo >>
rectangle rectangle << stereo >>
stack stack << stereo >>
storage storage << stereo >>
usecase usecase << stereo >>
usecase/ "usecase/" << stereo >>
@enduml

```

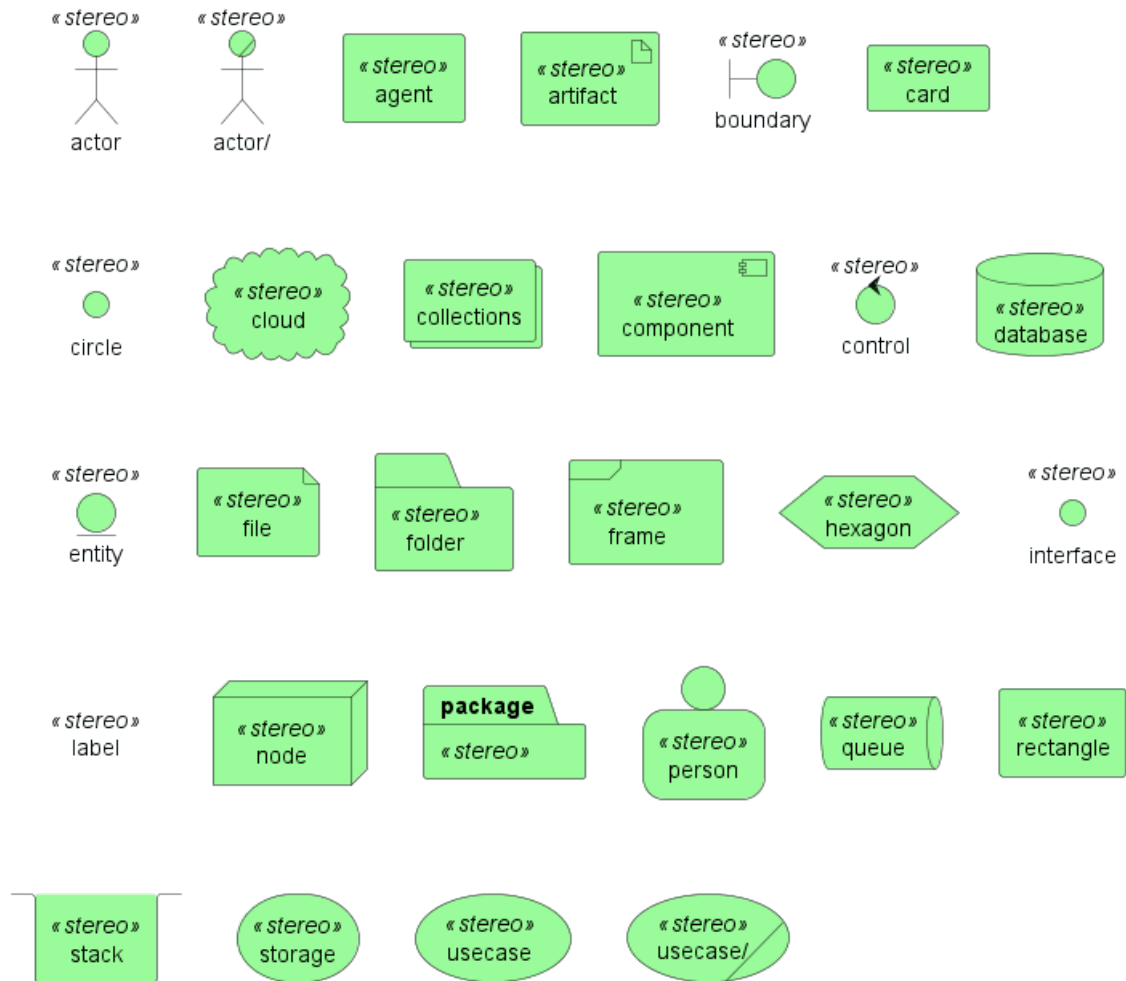

8.17 Display JSON Data on Deployment diagram

8.17.1 Simple example

```

@startuml
allowmixing

component Component
actor Actor
usecase Usecase
() Interface
node Node
cloud Cloud

json JSON {
    "fruit": "Apple",
    "size": "Large",
    "color": ["Red", "Green"]
}
@enduml

```

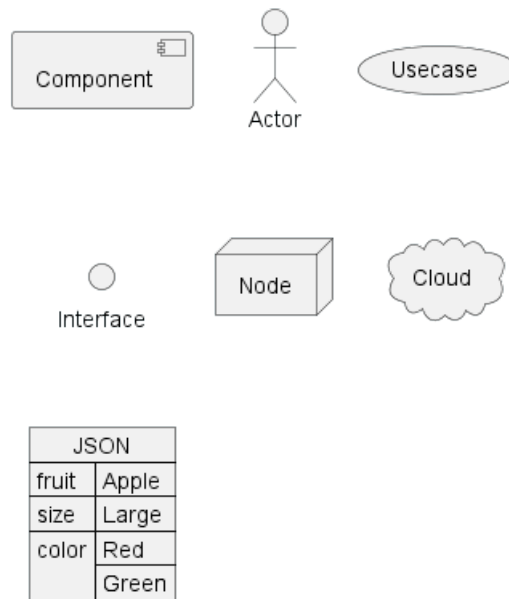

[Ref. QA-15481]

For another example, see on JSON page.

8.18 Mixing Deployment (Usecase, Component, Deployment) element within a Class or Object diagram

In order to add a Deployment element or a State element within a Class or Object diagram, you can use the `allowmixing` or `allow_mixing` directive.

8.18.1 Mixing all elements

```
@startuml
allowmixing

skinparam nodesep 10
abstract      abstract
abstract class "abstract class"
annotation    annotation
circle        circle
()            circle_short_form
class         class
diamond       diamond
<>           diamond_short_form
entity        entity
enum          enum
exception     exception
interface     interface
metaclass     metaclass
protocol      protocol
stereotype    stereotype
struct        struct
object        object
map map {
  key => value
}
json JSON {
  "fruit": "Apple",
```



```
    "size": "Large",  
    "color": ["Red", "Green"]  
}  
actor actor  
actor/ "actor/"  
agent agent  
artifact artifact  
boundary boundary  
card card  
circle circle  
cloud cloud  
collections collections  
component component  
control control  
database database  
entity entity  
file file  
folder folder  
frame frame  
hexagon hexagon  
interface interface  
label label  
node node  
package package  
person person  
queue queue  
rectangle rectangle  
stack stack  
storage storage  
usecase usecase  
usecase/ "usecase/"  
state state  
@enduml
```

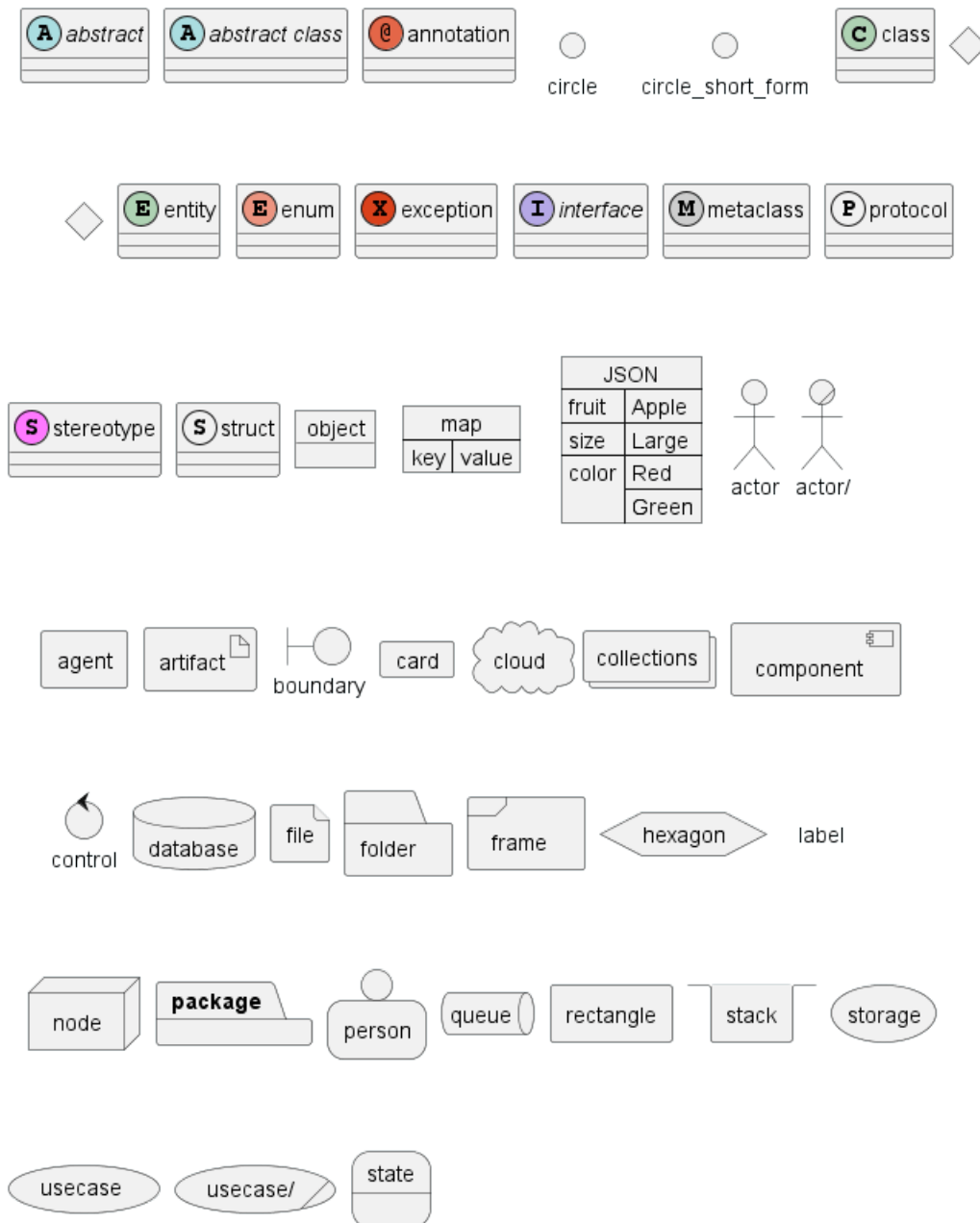

[Ref. QA-2335 and QA-5329]

8.19 Port [port, portIn, portOut]

You can added **port** with port, portin and portout keywords.

8.19.1 Port

```
@startuml
[c]
node node {
  port p1
  port p2
  port p3
  file f1
}
c --> p1
```



```

c --> p2
c --> p3
p1 --> f1
p2 --> f1
@enduml

```

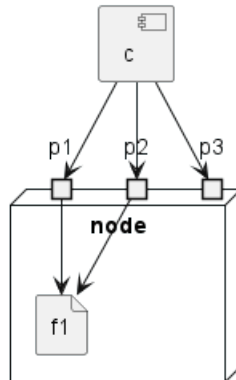

8.19.2 PortIn

```

@startuml
[c]
node node {
    portin p1
    portin p2
    portin p3
    file f1
}
c --> p1
c --> p2
c --> p3
p1 --> f1
p2 --> f1
@enduml

```

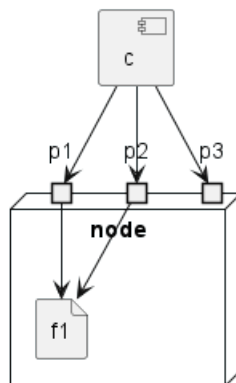

8.19.3 PortOut

```

@startuml
node node {
    portout p1
    portout p2
    portout p3
    file f1
}

```



```

}
[o]
p1 --> o
p2 --> o
p3 --> o
f1 --> p1
@enduml

```

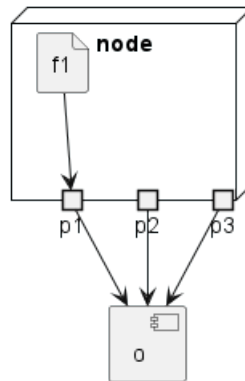

8.19.4 Mixing PortIn & PortOut

```

@startuml
[i]
node node {
    portin p1
    portin p2
    portin p3
    portout po1
    portout po2
    portout po3
    file f1
}
[o]

i --> p1
i --> p2
i --> p3
p1 --> f1
p2 --> f1
po1 --> o
po2 --> o
po3 --> o
f1 --> po1
@enduml

```

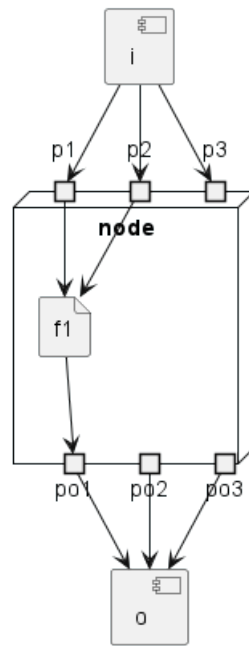

9 Diagrammes d'état

Les diagrammes d'états sont utilisés pour donner une description abstraite du comportement d'un système. Ce comportement est représenté comme une série d'événements qui peuvent se produire dans un ou plusieurs états possibles.

Using **PlantUML** to create state diagrams offers several advantages:

- **Text-Based Language:** Quickly define and visualize the states and transitions without the hassle of manual drawing.
- **Efficiency and Consistency:** Ensure streamlined diagram creation and easy version control.
- **Versatility:** Integrate with various documentation platforms and support multiple output formats.
- **Open-Source & Community Support:** Backed by a **strong community** that continuously contributes to its enhancements and offers invaluable resources.

9.1 Exemple simple

Vous devez utiliser [*] pour le début et la fin du diagramme d'état.

Utilisez --> pour les flèches.

```
@startuml
[*] --> State1
State1 --> [*]
State1 : this is a string
State1 : this is another string

State1 -> State2
State2 --> [*]

@enduml
```

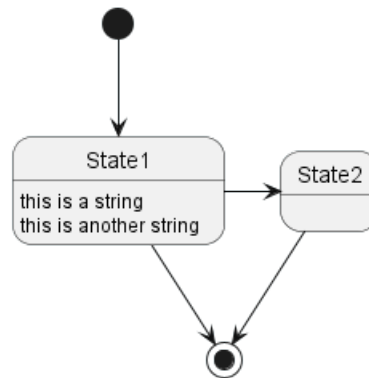

9.2 Autre rendu

Il est possible d'utiliser la directive `hide empty description` pour afficher l'état de façon plus compact.

```
@startuml
hide empty description
[*] --> State1
State1 --> [*]
State1 : this is a string
State1 : this is another string

State1 -> State2
State2 --> [*]

@enduml
```



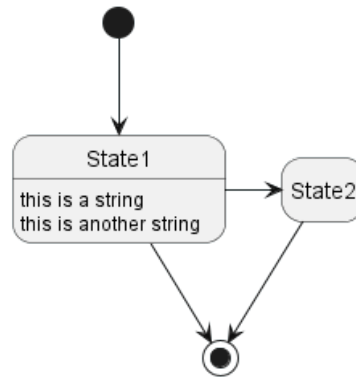

9.3 État composite

Un état peut également être composite. Vous devez alors le définir avec le mot-clé `state` et des accolades.

9.3.1 Sous-état interne

```

@startuml
scale 350 width
[*] --> NotShooting

state NotShooting {
    [*] --> Idle
    Idle --> Configuring : EvConfig
    Configuring --> Idle : EvConfig
}

state Configuring {
    [*] --> NewValueSelection
    NewValueSelection --> NewValuePreview : EvNewValue
    NewValuePreview --> NewValueSelection : EvNewValueRejected
    NewValuePreview --> NewValueSelection : EvNewValueSaved

    state NewValuePreview {
        State1 -> State2
    }
}

@enduml
  
```

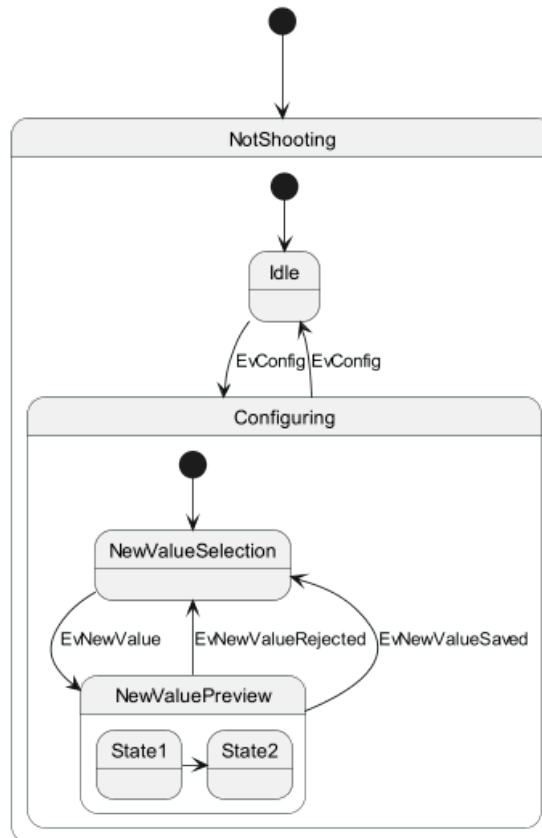

9.3.2 Lien entre sous-états

```

@startuml
state A {
    state X {
    }
    state Y {
    }
}

state B {
    state Z {
    }
}

X --> Z
Z --> Y
@enduml
    
```

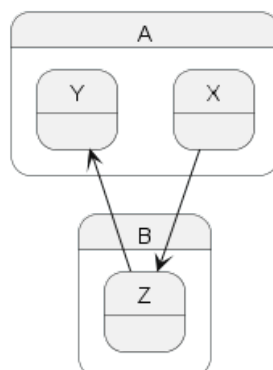

[Ref. QA-3300]

9.4 Nom long

Vous pouvez aussi utiliser le mot-clé `state` pour donner un nom avec des espaces à un état.

```

@startuml
scale 600 width

[*] -> State1
State1 --> State2 : Succeeded
State1 --> [*] : Aborted
State2 --> State3 : Succeeded
State2 --> [*] : Aborted
state State3 {
  state "Accumulate Enough Data\nLong State Name" as long1
  long1 : Just a test
  [*] --> long1
  long1 --> long1 : New Data
  long1 --> long1 : New Data
  long1 --> ProcessData : Enough Data
}
State3 --> State3 : Failed
State3 --> [*] : Succeeded / Save Result
State3 --> [*] : Aborted

@enduml

```

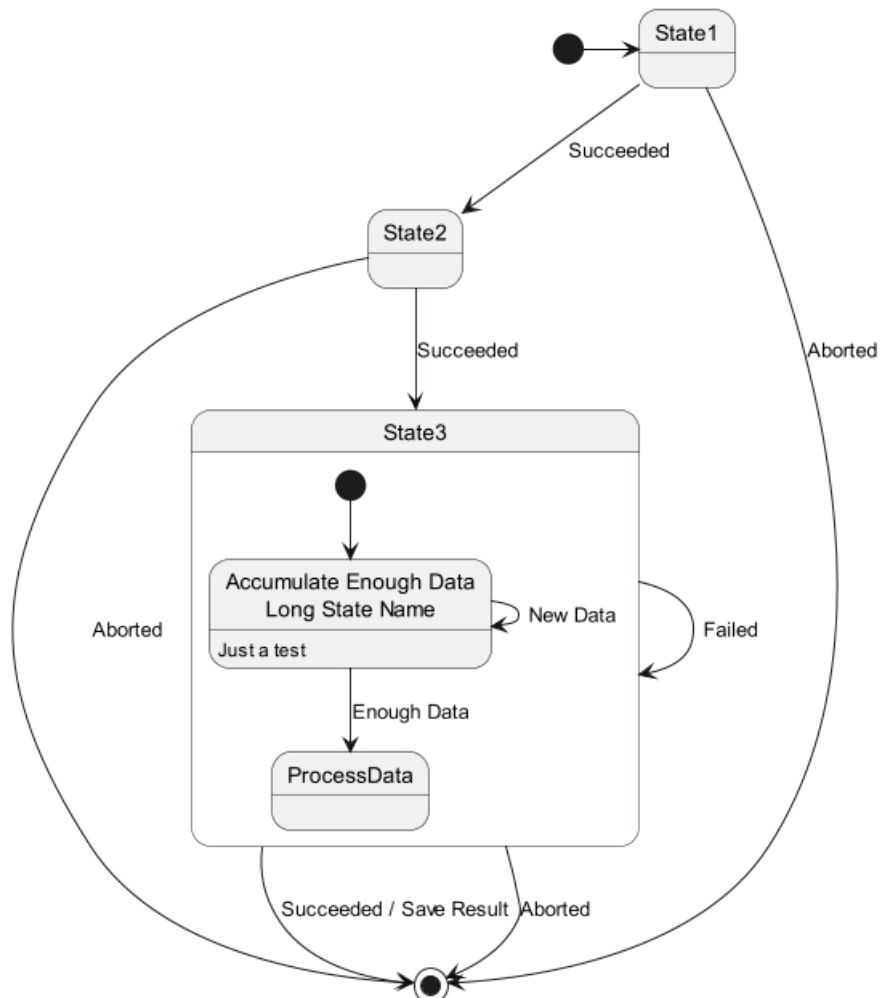

9.5 Historique de sous-état [[H], [H*]]

Vous pouvez utiliser [H] pour l'historique et [H*] pour l'historique profond d'un sous-état.

```
@startuml
[*] -> State1
State1 --> State2 : Succeeded
State1 --> [*] : Aborted
State2 --> State3 : Succeeded
State2 --> [*] : Aborted
state State3 {
  state "Accumulate Enough Data" as long1
  long1 : Just a test
  [*] --> long1
  long1 --> long1 : New Data
  long1 --> ProcessData : Enough Data
  State2 --> [H]: Resume
}
State3 --> State2 : Pause
State2 --> State3[H*]: DeepResume
State3 --> State3 : Failed
State3 --> [*] : Succeeded / Save Result
State3 --> [*] : Aborted
@enduml
```

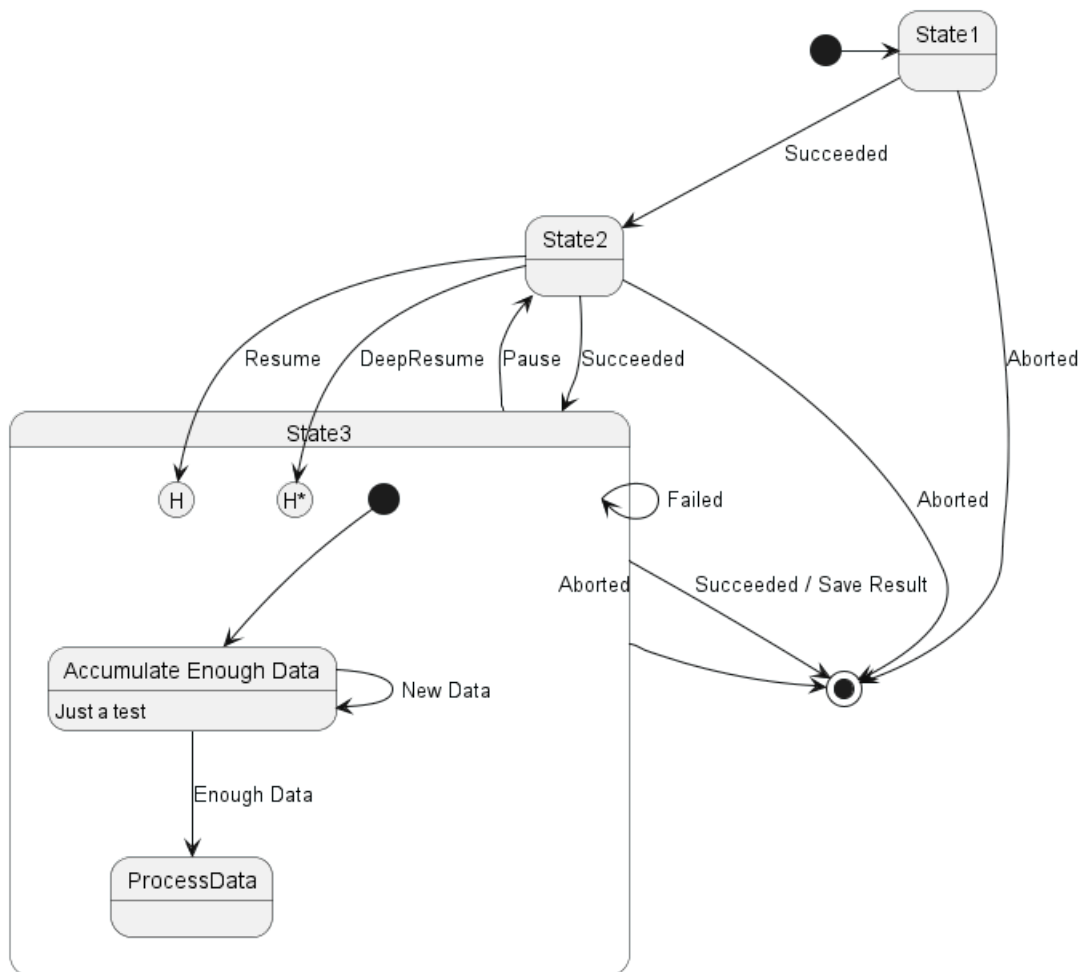

9.6 États parallèles [fork, join]

Il est possible d'afficher des états parallèles grâce aux stéréotypes <<fork>> et <<join>>.



```

@startuml

state fork_state <<fork>>
[*] --> fork_state
fork_state --> State2
fork_state --> State3

state join_state <<join>>
State2 --> join_state
State3 --> join_state
join_state --> State4
State4 --> [*]

@enduml

```

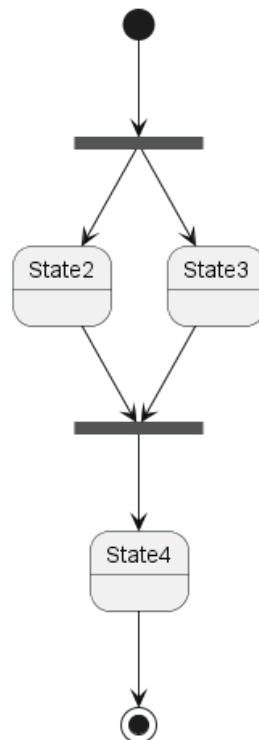

9.7 États concurrents [-, ||]

Vous pouvez définir un état concurrent dans un état composé en utilisant le symbole -- ou || comme séparateur.

9.7.1 Séparateur horizontal --

```

@startuml
[*] --> Active

state Active {
    [*] -> NumLockOff
    NumLockOff --> NumLockOn : EvNumLockPressed
    NumLockOn --> NumLockOff : EvNumLockPressed
    --
    [*] -> CapsLockOff
    CapsLockOff --> CapsLockOn : EvCapsLockPressed
    CapsLockOn --> CapsLockOff : EvCapsLockPressed
    --
    [*] -> ScrollLockOff
}

```



```

    ScrollLockOff --> ScrollLockOn : EvCapsLockPressed
    ScrollLockOn --> ScrollLockOff : EvCapsLockPressed
}

@enduml

```

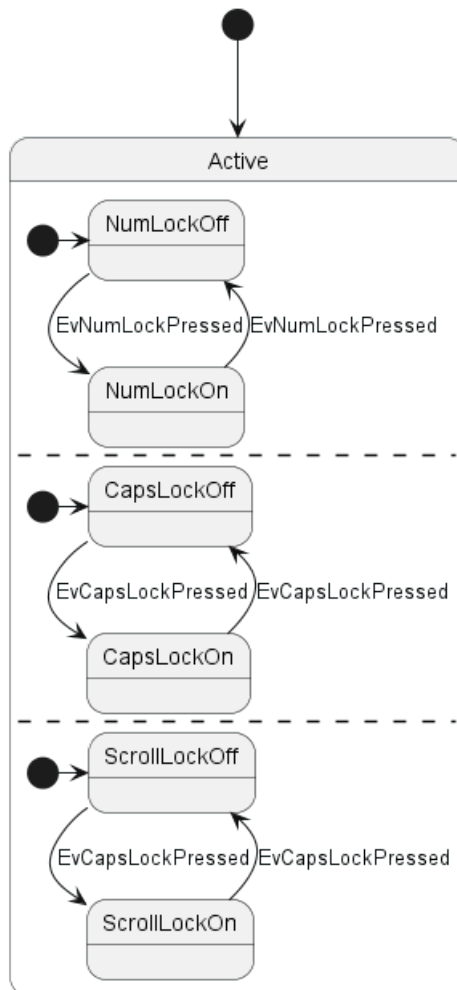

9.7.2 Séparateur vertical ||

```

@startuml
[*] --> Active

state Active {
    [*] -> NumLockOff
    NumLockOff --> NumLockOn : EvNumLockPressed
    NumLockOn --> NumLockOff : EvNumLockPressed
    ||
    [*] -> CapsLockOff
    CapsLockOff --> CapsLockOn : EvCapsLockPressed
    CapsLockOn --> CapsLockOff : EvCapsLockPressed
    ||
    [*] -> ScrollLockOff
    ScrollLockOff --> ScrollLockOn : EvCapsLockPressed
    ScrollLockOn --> ScrollLockOff : EvCapsLockPressed
}

@enduml

```



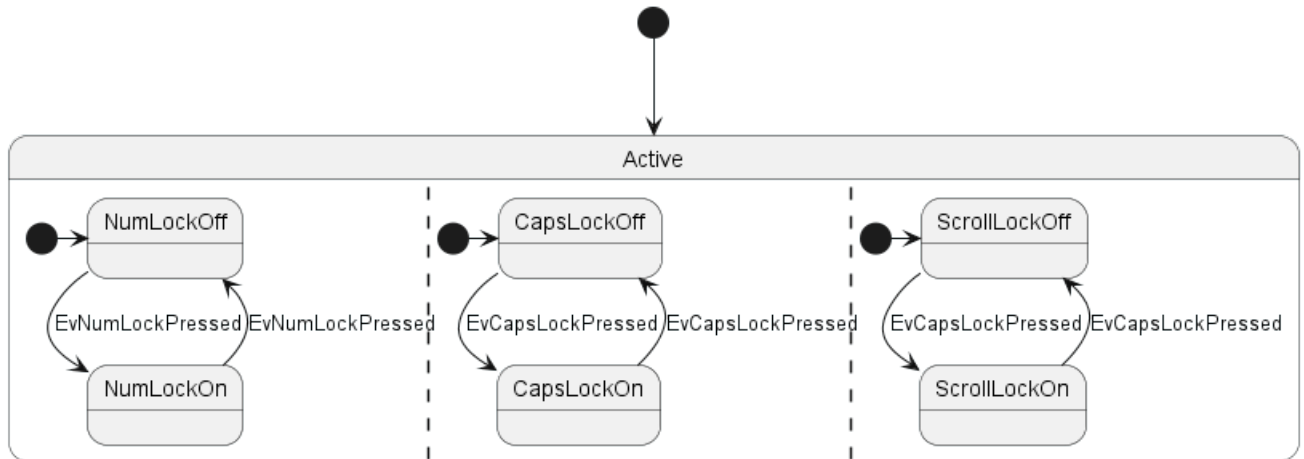

[Ref. QA-3086]

9.8 Conditionnel [choice]

Le stéréotype <<choice>> peut être utilisé pour signifier des états conditionnels.

```

@startuml
state "Req(Id)" as ReqId <<sdlreceive>>
state "Minor(Id)" as MinorId
state "Major(Id)" as MajorId

state c <<choice>>

Idle --> ReqId
ReqId --> c
c --> MinorId : [Id <= 10]
c --> MajorId : [Id > 10]
@enduml

```

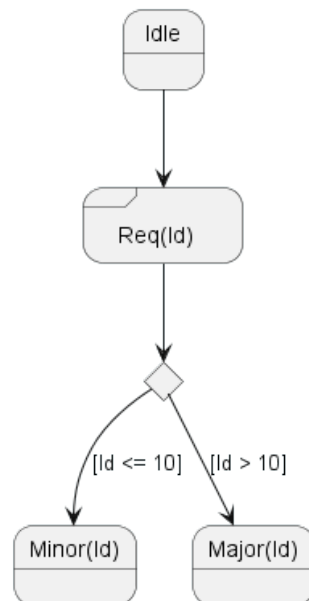

9.9 Exemple avec tous les stéréotypes [choice, fork, join, end]

```

@startuml
state choice1 <<choice>>

```



```

state fork1    <<fork>>
state join2    <<join>>
state end3     <<end>>

[*]    --> choice1 : de "start"\nà "choice"
choice1 --> fork1   : de "choice"\nà "fork"
choice1 --> join2  : de "choice"\nà "join"
choice1 --> end3   : de "choice"\nà "end"

fork1   ---> State1 : de "fork"\nà "state"
fork1   --> State2 : de "fork"\nà "state"

State2  --> join2  : de "state"\nà "join"
State1  --> [*]   : de "state"\nà "end"

join2   --> [*]   : de "join"\nà "end"
@enduml

```

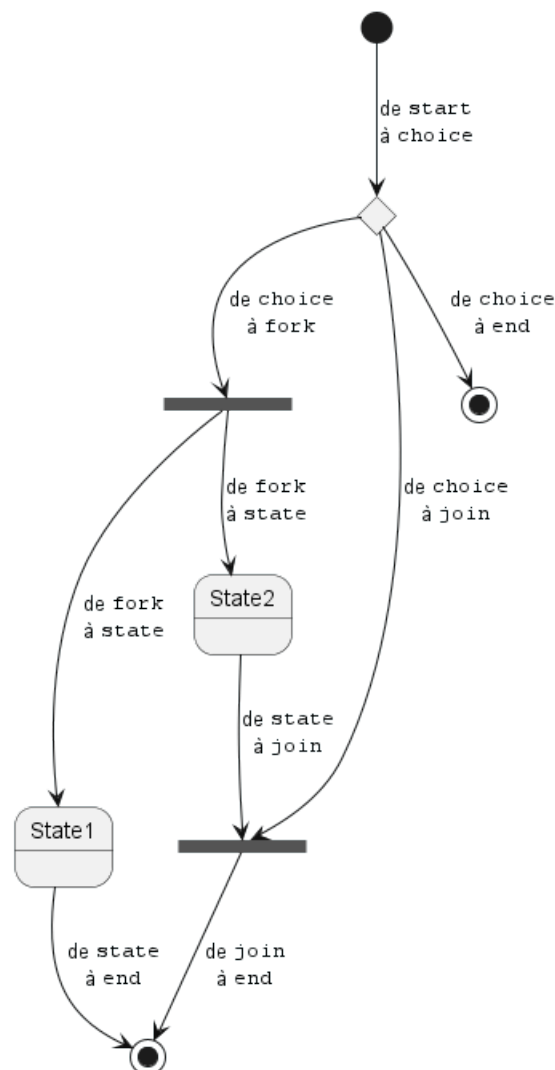

[Réf. QA-404 et QA-1159]

[Ref. QA-404, QA-1159 and GH-887]

9.10 Petits cercles [entryPoint, exitPoint]

Vous pouvez ajouter de petits cercles [point] avec les stéréotypes <<entryPoint>> et <<exitPoint>> :



```

@startuml
state Somp {
  state entry1 <<entryPoint>>
  state entry2 <<entryPoint>>
  state sin
  entry1 --> sin
  entry2 -> sin
  sin -> sin2
  sin2 --> exitA <<exitPoint>>
}

[*] --> entry1
exitA --> Foo
Foo1 -> entry2
@enduml

```

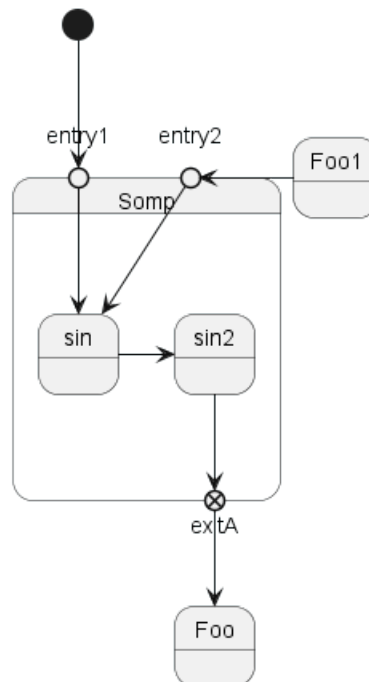

9.11 Petits carrés [inputPin, outputPin]

Vous pouvez ajouter de petits carrés [pin] avec les stéréotypes <<inputPin>> et <<outputPin>> :

```

@startuml
state Somp {
  state entry1 <<inputPin>>
  state entry2 <<inputPin>>
  state sin
  entry1 --> sin
  entry2 -> sin
  sin -> sin2
  sin2 --> exitA <<outputPin>>
}

[*] --> entry1
exitA --> Foo
Foo1 -> entry2
@enduml

```

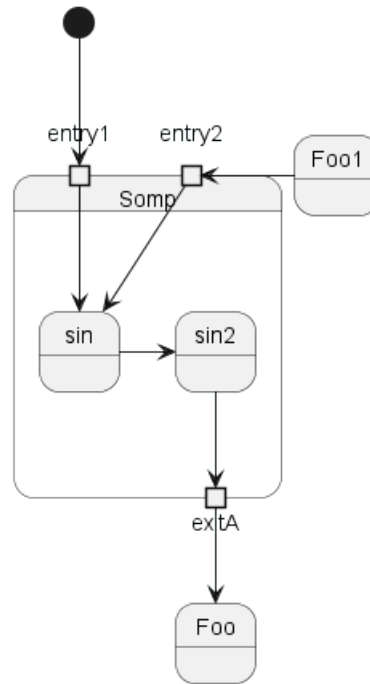

[Réf. QA-4309]

9.12 Multiples petits carrés [*expansionInput*, *expansionOutput*]

Vous pouvez ajouter de multiples petits carrés [*expansion*] avec les stéréotypes <<*expansionInput*>> et <<*expansionOutput*>> :

```
@startuml
state Somp {
  state entry1 <<expansionInput>>
  state entry2 <<expansionInput>>
  state sin
  entry1 --> sin
  entry2 -> sin
  sin -> sin2
  sin2 --> exitA <<expansionOutput>>
}
```

```
[*] --> entry1
exitA --> Foo
Foo1 -> entry2
@enduml
```



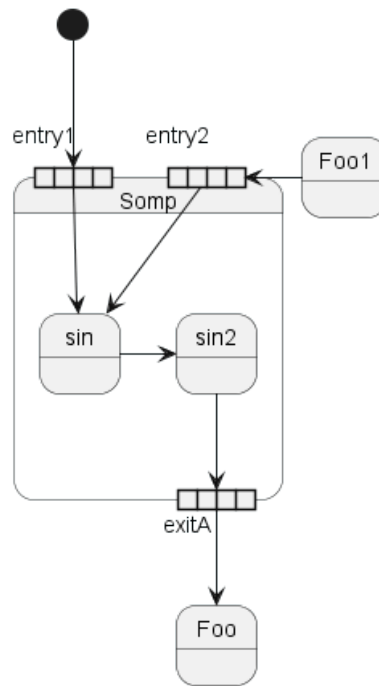

[Réf. QA-4309]

9.13 Direction des flèches

Vous pouvez utiliser `->` pour les flèches horizontales. Il est aussi possible de forcer la direction de la flèche avec la syntaxe suivante:

- `-down->` (flèche par défaut)
- `-right->` or `->`
- `-left->`
- `-up->`

```
@startuml
```

```
[*] -up-> First
First -right-> Second
Second --> Third
Third -left-> Last
```

```
@enduml
```

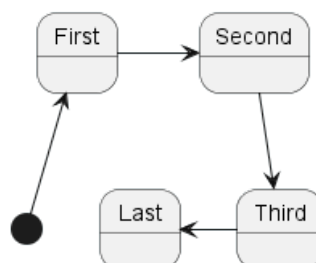

Vous pouvez aussi utiliser une notation abrégée, avec soit le premier caractère de la direction (par exemple `-d-` à la place de `-down-`) ou bien les deux premiers caractères (`-do-`).

Veuillez noter qu'il ne faut pas abuser de cette fonction : *Graphviz* donne généralement de bons résultats sans peaufinage.



9.14 Changer la couleur ou le style des flèches

Vous pouvez modifier la couleur et/ou le style des flèches.

```
@startuml
State S1
State S2
S1 -[#DD00AA]-> S2
S1 -left[#yellow]-> S3
S1 -up[#red,dashed]-> S4
S1 -right[dotted,#blue]-> S5

X1 -[dashed]-> X2
Z1 -[dotted]-> Z2
Y1 -[#blue,bold]-> Y2
@enduml
```

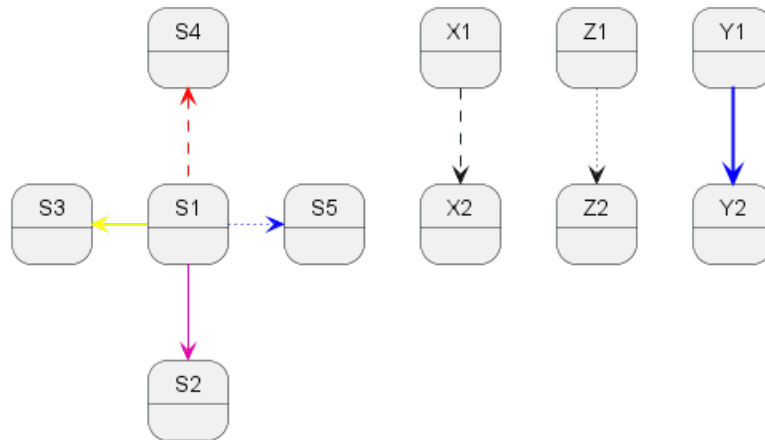

[Réf. Incubation: Change line color in state diagrams]

9.15 Note

Vous pouvez définir des notes avec les mots clés suivant: `note left of`, `note right of`, `note top of`, `note bottom of`

Vous pouvez aussi définir des notes sur plusieurs lignes.

```
@startuml

[*] --> Active
Active --> Inactive

note left of Active : this is a short\nnote

note right of Inactive
  A note can also
  be defined on
  several lines
end note

@enduml
```



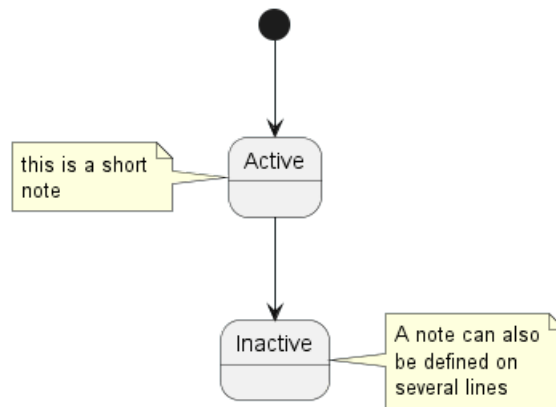

Vous pouvez aussi avoir des notes flottantes.

```

@startuml
state foo
note "This is a floating note" as N1
@enduml
  
```

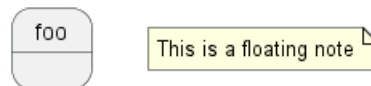

9.16 Note sur un lien

Vous pouvez ajouter une note sur un lien entre états avec le mot clé `note on link`.

```

@startuml
[*] -> State1

State1 --> State2
note on link
    this is a state-transition note
end note
@enduml
  
```

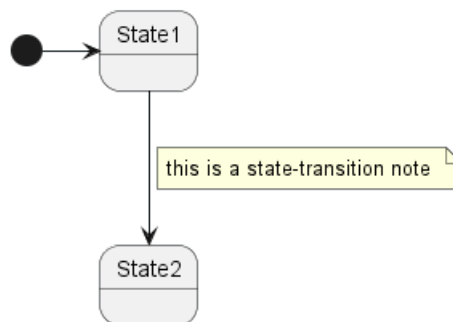

9.17 Plus de notes

Vous pouvez mettre des notes sur les états de composite

```

@startuml
[*] --> NotShooting

state "Not Shooting State" as NotShooting {
    state "Idle mode" as Idle
  }
  
```



```

state "Configuring mode" as Configuring
[*] --> Idle
Idle --> Configuring : EvConfig
Configuring --> Idle : EvConfig
}

note right of NotShooting : This is a note on a composite state

@enduml

```

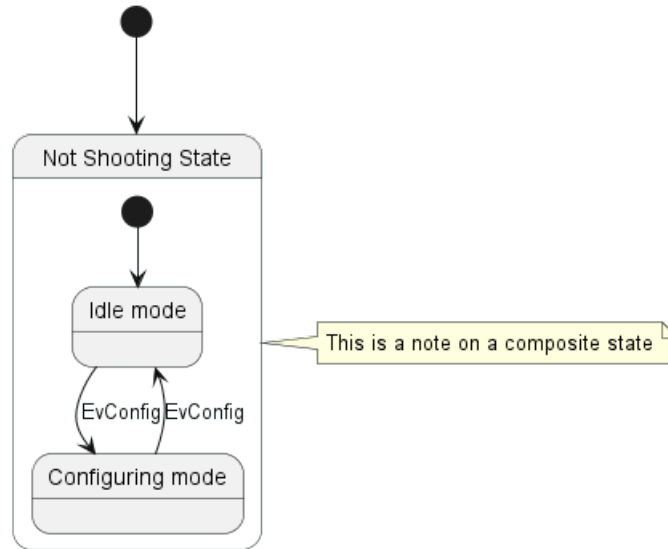

9.18 Changer les couleurs localement [Inline color]

```

@startuml
state CurrentSite #pink {
    state HardwareSetup #lightblue {
        state Site #brown
        Site -[hidden]-> Controller
        Controller -[hidden]-> Devices
    }
    state PresentationSetup{
        Groups -[hidden]-> PlansAndGraphics
    }
    state Trends #FFFF77
    state Schedule #magenta
    state AlarmSupression
}
@enduml

```

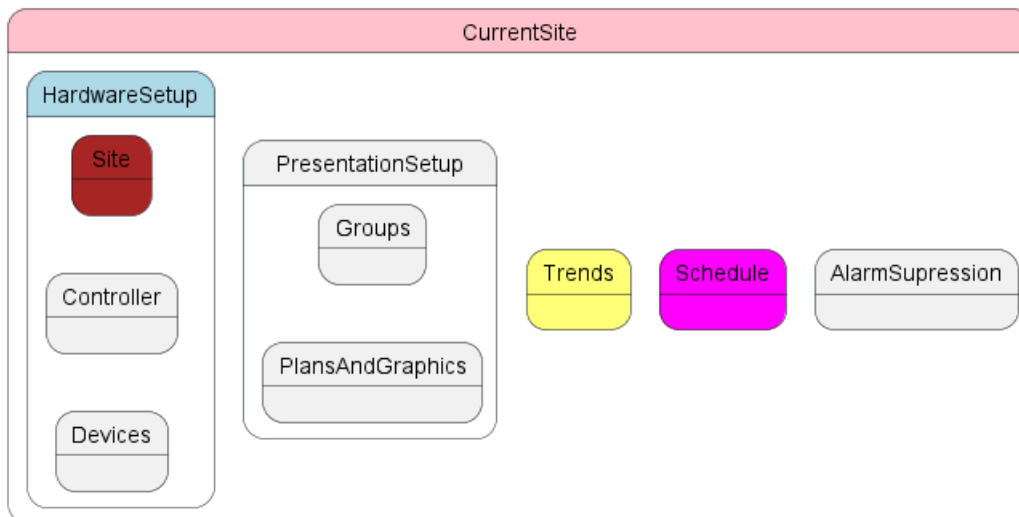

[Réf. QA-1812]

9.19 Skinparam

Utilisez la commande skinparam pour changer la couleur et la mise en forme du texte du schéma.

Vous pouvez utiliser cette commande :

- Dans la définition du diagramme, comme pour les autres commandes,
- Dans un fichier inclus,
- Dans un fichier de configuration, renseigné dans la ligne de commande ou la tâche ANT.

Vous pouvez définir une couleur spécifique et une police d'écriture pour les états stéréotypés.

```
@startuml
skinparam backgroundColor LightYellow
skinparam state {
  StartColor MediumBlue
  EndColor Red
  BackgroundColor Peru
  BackgroundColor<<Warning>> Olive
  BorderColor Gray
  FontName Impact
}

[*] --> NotShooting

state "Not Shooting State" as NotShooting {
  state "Idle mode" as Idle <<Warning>>
  state "Configuring mode" as Configuring
  [*] --> Idle
  Idle --> Configuring : EvConfig
  Configuring --> Idle : EvConfig
}

NotShooting --> [*]
@enduml
```

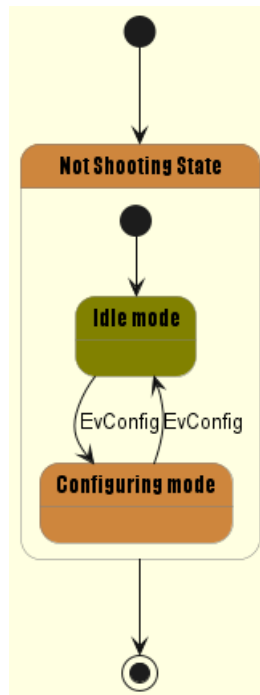

9.19.1 Test de tous les skinparam spécifiques aux diagrammes d'état:

```

@startuml
skinparam State {
  AttributeFontColor blue
  AttributeFontName serif
  AttributeFontSize 9
  AttributeFontStyle italic
  BackgroundColor palegreen
  BorderColor violet
  EndColor gold
  FontColor red
  FontName Sanserif
  FontSize 15
  FontStyle bold
  StartColor silver
}
  
```

```

state A : a a a\na
state B : b b b\nb
  
```

```

[*] -> A : start
A -> B : a2b
B -> [*] : end
@enduml
  
```

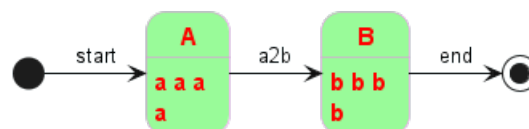

9.20 Changement de style

Vous pouvez changer de style

```
@startuml
```



```

<style>
stateDiagram {
  BackgroundColor Peru
  'LineColor Gray
  FontName Impact
  FontColor Red
  arrow {
    FontSize 13
    LineColor Blue
  }
}
</style>

```

```

[*] --> NotShooting

```

```

state "Not Shooting State" as NotShooting {
  state "Idle mode" as Idle <<Warning>>
  state "Configuring mode" as Configuring
  [*] --> Idle
  Idle --> Configuring : EvConfig
  Configuring --> Idle : EvConfig
}

```

```

NotShooting --> [*]
@enduml

```

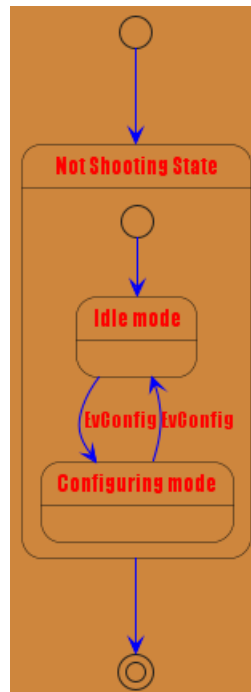

[Ref. [GH-880](<https://github.com/plantuml/plantuml/issues/880#issuecomment-1022278138>)]

9.21 Modifier la couleur et le style d'un état (style en ligne)

Vous pouvez modifier la couleur ou le style d'un état individuel en utilisant la notation suivante

- #color ##[style]color

Avec la couleur de fond d'abord (#color), puis le style de ligne et la couleur de ligne (##[style]color)



```

@startuml
state FooGradient #red-green ##00FFFF
state FooDashed #red|green ##[dashed]blue {
}
state FooDotted ##[dotted]blue {
}
state FooBold ##[bold] {
}
state Foo1 ##[dotted]green {
state inner1 ##[dotted]yellow
}

state out ##[dotted]gold

state Foo2 ##[bold]green {
state inner2 ##[dotted]yellow
}
inner1 -> inner2
out -> inner2
@enduml

```

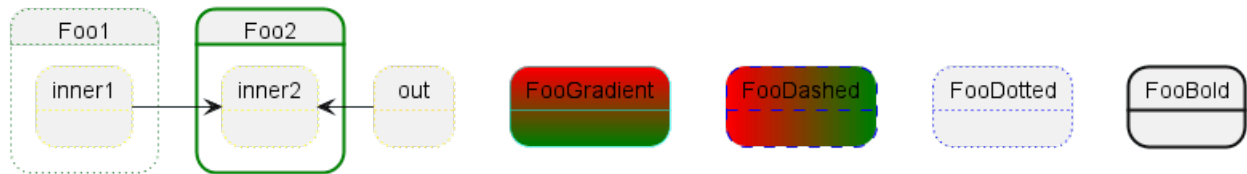

[Réf. QA-1487]

- #color;line:color;line.[bold|dashed|dotted];text:color

TODO: FIXME text:color semble ne pas être pris en compte **TODO: FIXME**

```

@startuml
@startuml
state FooGradient #red-green;line:00FFFF
state FooDashed #red|green;line.dashed;line:blue {
}
state FooDotted #line.dotted;line:blue {
}
state FooBold #line.bold {
}
state Foo1 #line.dotted;line:green {
state inner1 #line.dotted;line:yellow
}

state out #line.dotted;line:gold

state Foo2 #line.bold;line:green {
state inner2 #line.dotted;line:yellow
}
inner1 -> inner2
out -> inner2
@enduml
@enduml

```



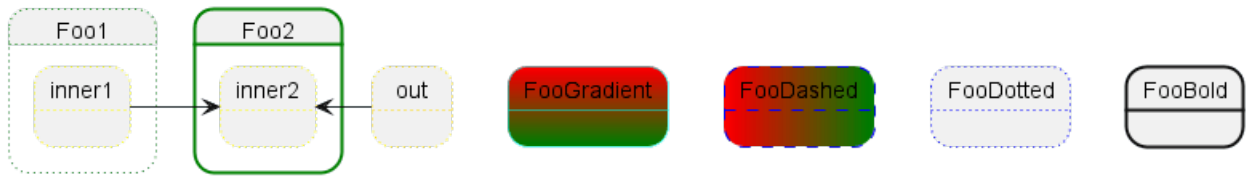

```

@startuml
state s1 : s1 description
state s2 #pink;line:red;line.bold;text:red : s2 description
state s3 #palegreen;line:green;line.dashed;text:green : s3 description
state s4 #aliceblue;line:blue;line.dotted;text:blue : s4 description
@enduml

```



[Adapté de QA-3770]

9.22 Alias

With State you can use alias, like:

```

@startuml
state alias1
state "alias2"
state "long name" as alias3
state alias4 as "long name"

alias1 : ""state alias1""
alias2 : ""state "alias2"""
alias3 : ""state "long name" as alias3""
alias4 : ""state alias4 as "long name"""

alias1 -> alias2
alias2 -> alias3
alias3 -> alias4
@enduml

```

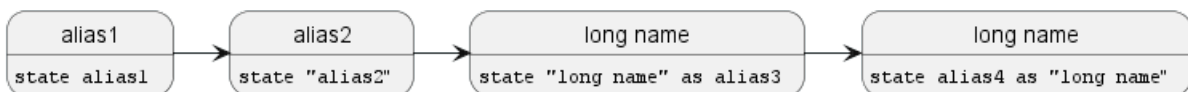

or:

```

@startuml
state alias1 : ""state alias1""
state "alias2" : ""state "alias2"""
state "long name" as alias3 : ""state "long name" as alias3""
state alias4 as "long name" : ""state alias4 as "long name"""

alias1 -> alias2
alias2 -> alias3
alias3 -> alias4
@enduml

```

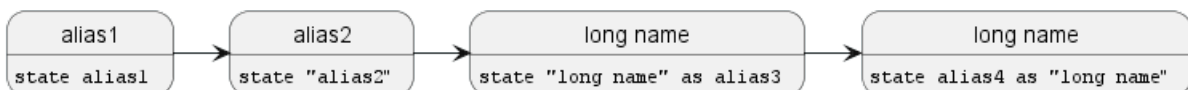

9.23 Display JSON Data on State diagram

9.23.1 Simple example

```

@startuml
state "A" as stateA
state "C" as stateC {
  state B
}

json jsonJ {
  "fruit": "Apple",
  "size": "Large",
  "color": ["Red", "Green"]
}
@enduml

```

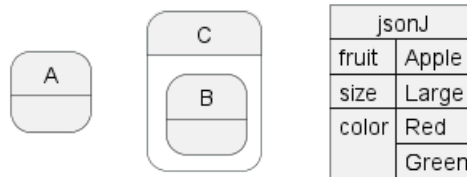

[Ref. QA-17275]

For another example, see on JSON page.

10 Diagramme de temps

Ceci est encore en développement. Vous pouvez proposer de nouvelles fonctionnalités si vous en avez besoin.

10.1 Définitions des participants

Les participants sont déclarés à l'aide des mots-clé **concise** ou **robust**, en fonction de la façon dont vous souhaitez les dessiner.

- **concise**: Un signal simplifié conçu pour montrer le déplacement des données (utile pour les messages).
- **robust**: Un signal linéaire complexe conçu pour montrer la transition d'un état à un autre. Ce signal peut avoir de nombreux états.
- **clock**: Un signal qui transitionne de façon répétée entre les états haut et bas à rythme régulier.
- **binary**: Un signal spécifique restreint à seulement deux états (binaire).

Les changements d'état sont notifiés avec la notation @ et le verbe **is**.

```
@startuml
robust "Web Browser" as WB
concise "Web User" as WU

@0
WU is Idle
WB is Idle

@100
WU is Waiting
WB is Processing

@300
WB is Waiting
@enduml
```

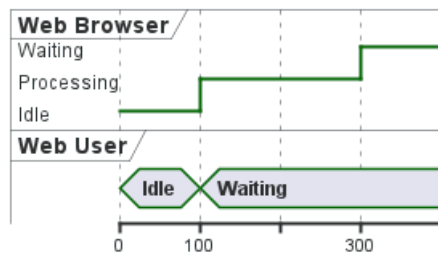

[Ref. [QA-14631](<https://forum.plantuml.net/14631>) and [QA-14647](<https://forum.plantuml.net/14647>)]
 [Ref. QA-14631, QA-14647 and QA-11288]

10.2 Horloge et signaux binaires

It's also possible to have binary and clock signal, using the following keywords:

- **binary**
- **clock**

```
@startuml
clock clk with period 1
binary "Enable" as EN

@0
```



```

EN is low
@5
EN is high
@10
EN is low
@enduml

```

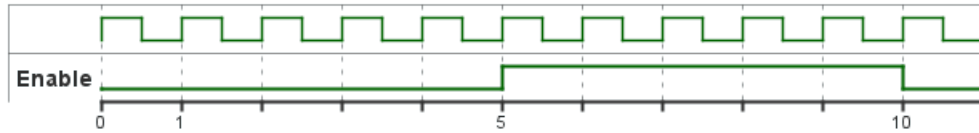

10.3 Ajout de messages

Vous pouvez rajouter des messages à l'aide de la syntaxe suivante.

```

@startuml
robust "Web Browser" as WB
concise "Web User" as WU

@0
WU is Idle
WB is Idle

@100
WU -> WB : URL
WU is Waiting
WB is Processing

@300
WB is Waiting
@enduml

```

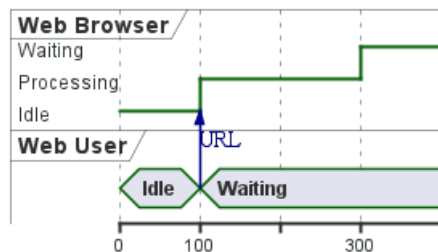

10.4 Référence relative de temps

Avec la notation @, il est possible d'utiliser une notation relative du temps.

```

@startuml
robust "DNS Resolver" as DNS
robust "Web Browser" as WB
concise "Web User" as WU

@0
WU is Idle
WB is Idle
DNS is Idle

@+100

```



```

WU -> WB : URL
WU is Waiting
WB is Processing

@+200
WB is Waiting
WB -> DNS@+50 : Resolve URL

@+100
DNS is Processing

@+300
DNS is Idle
@enduml

```

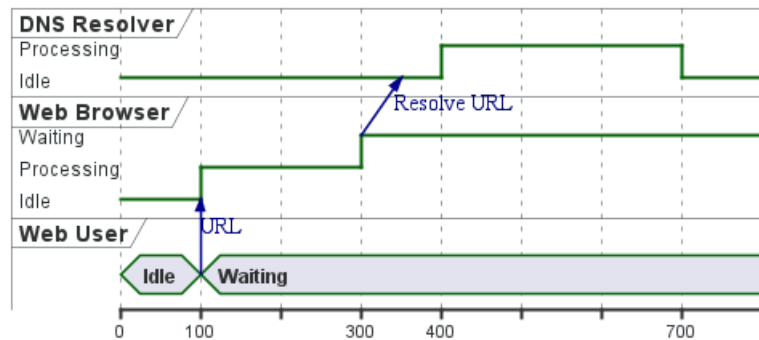

10.5 Points d'ancrage

Au lieu d'utiliser le temps absolu ou relatif sur un temps absolu, vous pouvez définir un temps comme point d'ancrage en utilisant le mot clé `as` et en commençant le nom par un :

```

@XX as :<anchor point name>

@startuml
clock clk with period 1
binary "enable" as EN
concise "dataBus" as db

@0 as :start
@5 as :en_high
@10 as :en_low
@:en_high-2 as :en_highMinus2

@:start
EN is low
db is "0x0000"

@:en_high
EN is high

@:en_low
EN is low

@:en_highMinus2
db is "0xf23a"

@:en_high+6
db is "0x0000"

```



```
@enduml
```

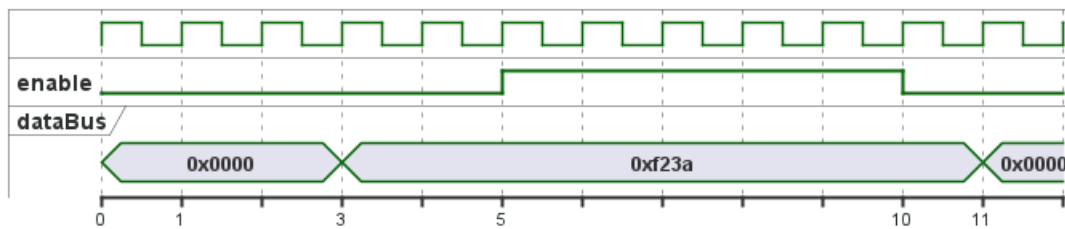

10.6 Définition participant par participant

Plutôt que de déclarer le diagramme dans l'ordre chronologique, il est possible de le définir participant par participant.

```
@startuml
robust "Web Browser" as WB
concise "Web User" as WU
```

```
@WB
0 is idle
+200 is Proc.
+100 is Waiting
```

```
@WU
0 is Waiting
+500 is ok
@enduml
```



10.7 Choix du zoom

Il est possible de choisir une échelle d'affichage précise.

```
@startuml
concise "Web User" as WU
scale 100 as 50 pixels
```

```
@WU
0 is Waiting
+500 is ok
@enduml
```



10.8 État initial

Vous pouvez également définir un état initial.



```

@startuml
robust "Web Browser" as WB
concise "Web User" as WU

WB is Initializing
WU is Absent

@WB
0 is idle
+200 is Processing
+100 is Waiting

@WU
0 is Waiting
+500 is ok
@enduml

```

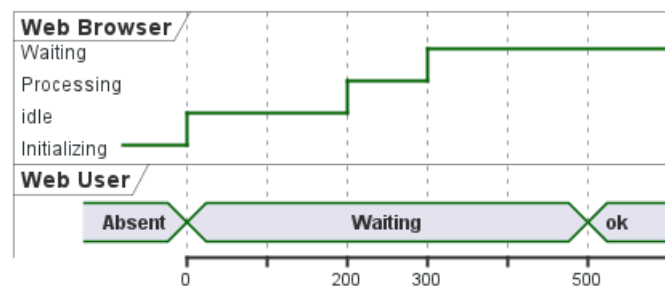

10.9 État complexe

Un signal peut se trouver dans un état indéfini

```

@startuml
robust "Signal1" as S1
robust "Signal2" as S2
S1 has 0,1,2,hello
S2 has 0,1,2
@0
S1 is 0
S2 is 0
@100
S1 is {0,1} #SlateGrey
S2 is {0,1}
@200
S1 is 1
S2 is 0
@300
S1 is hello
S2 is {0,2}
@enduml

```

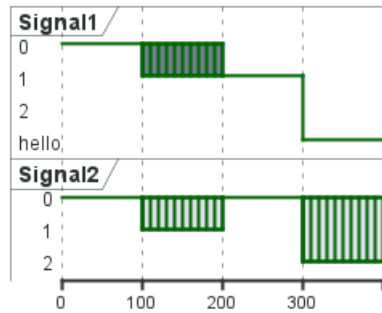

[Ref. [QA-11936](<https://forum.plantuml.net/11936>) and [QA-15933](<https://forum.plantuml.net/15933>)]

10.10 Hidden state

It is also possible to hide some state.

```
@startuml
concise "Web User" as WU
```

```
@0
WU is {-}
```

```
@100
WU is A1
```

```
@200
WU is {-}
```

```
@300
WU is {hidden}
```

```
@400
WU is A3
```

```
@500
WU is {-}
@enduml
```

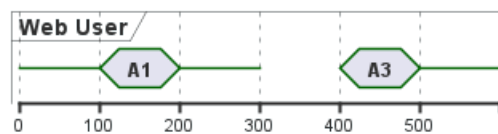

[Ref. [QA-12222](<https://forum.plantuml.net/12222>)]

10.11 Masquer l'axe du temps

Il est possible de masquer l'axe du temps

```
@startuml
hide time-axis
concise "Web User" as WU
```

```
WU is Absent
```

```
@WU
0 is Waiting
+500 is ok
```



```
@enduml
```

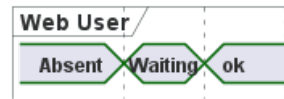

10.12 Utilisation de l'heure et de la date

Il est possible d'utiliser l'heure ou la date.

```
@startuml
```

```
robust "Web Browser" as WB
concise "Web User" as WU
```

```
@2019/07/02
```

```
WU is Idle
```

```
WB is Idle
```

```
@2019/07/04
```

```
WU is Waiting : some note
```

```
WB is Processing : some other note
```

```
@2019/07/05
```

```
WB is Waiting
```

```
@enduml
```

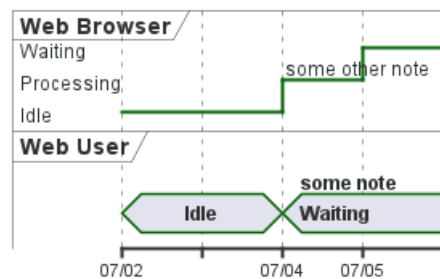

```
@startuml
```

```
robust "Web Browser" as WB
concise "Web User" as WU
```

```
@1:15:00
```

```
WU is Idle
```

```
WB is Idle
```

```
@1:16:30
```

```
WU is Waiting : some note
```

```
WB is Processing : some other note
```

```
@1:17:30
```

```
WB is Waiting
```

```
@enduml
```



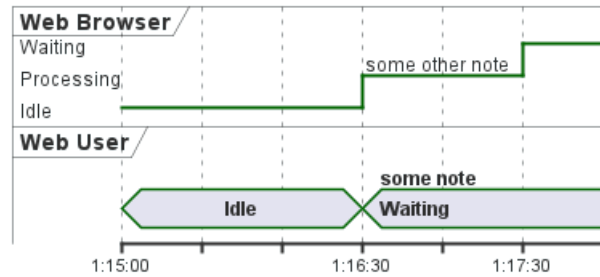

10.13 Ajout de contraintes

Il est possible d'afficher des contraintes de temps sur les diagrammes.

```
@startuml
robust "Web Browser" as WB
concise "Web User" as WU
```

```
WB is Initializing
WU is Absent
```

```
@WB
0 is idle
+200 is Processing
+100 is Waiting
WB@0 <-> @50 : {50 ms lag}
```

```
@WU
0 is Waiting
+500 is ok
@200 <-> @+150 : {150 ms}
@enduml
```

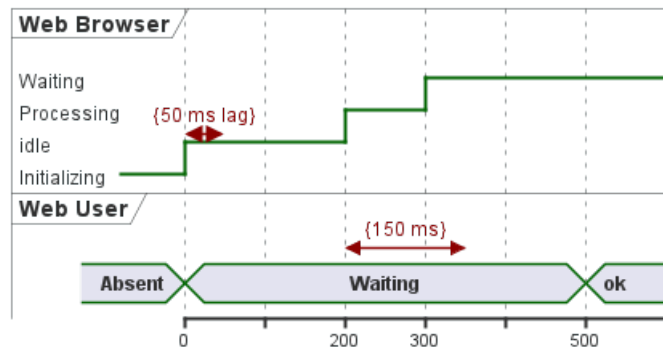

10.14 Période surlignée

Vous pouvez surligner une partie du diagramme

```
@startuml
robust "Web Browser" as WB
concise "Web User" as WU
```

```
@0
WU is Idle
WB is Idle
```

```
@100
WU -> WB : URL
```



```

WU is Waiting #LightCyan;line:Aqua

@200
WB is Proc.

@300
WU -> WB@350 : URL2
WB is Waiting

@+200
WU is ok

@+200
WB is Idle

highlight 200 to 450 #Gold;line:DimGrey : This is my caption
@enduml

```

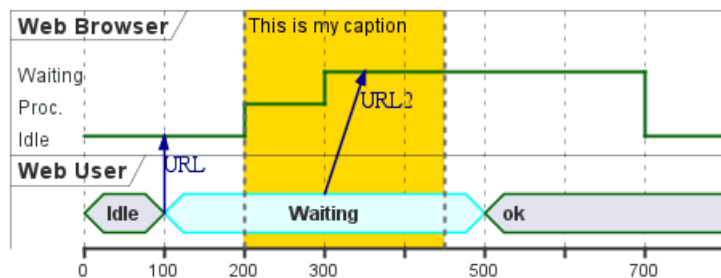

[Ref. [QA-10868](<https://forum.plantuml.net/10868/highlighted-periods-in-timing-diagrams>)]

10.15 Using notes

You can use the `note top of` and `note bottom of` keywords to define notes related to a single object or participant (*available only for concise or binary object*).

```

@startuml
robust "Web Browser" as WB
concise "Web User" as WU

@0
WU is Idle
WB is Idle

@100
WU is Waiting
WB is Processing
note top of WU : first note\non several\nlines
note bottom of WU : second note\non several\nlines

@300
WB is Waiting
@enduml

```



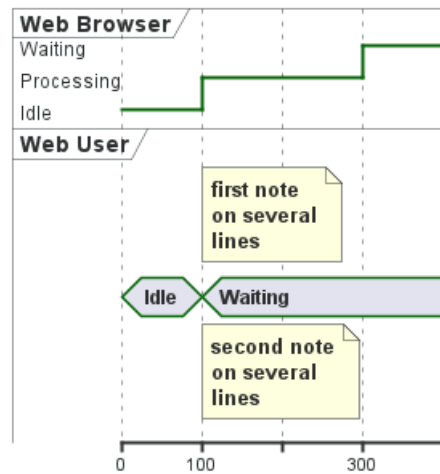

[Ref. QA-6877, GH-1465]

10.16 Ajout de textes

Vous pouvez ajouter éventuellement un titre, une entête, un pied de page, une légende ou un libellé :

```

@startuml
Title Un titre
header: Une entête
footer: Un pied de page
legend
Une légende
end legend
caption Un libellé

robust "Navigateur web" as WB
concise "Internaute" as WU

@0
WU is Inactif
WB is Inactif

@100
WU is EnAttente
WB is EnTraitement

@300
WB is EnAttente
@enduml

```

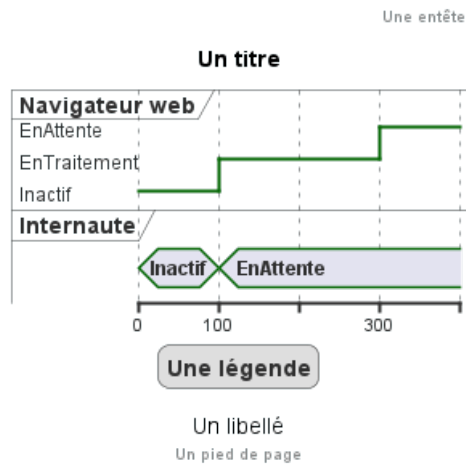

10.17 Exemple complet

Merci à Adam Rosien pour cet exemple

```

@startuml
concise "Client" as Client
concise "Server" as Server
concise "Response freshness" as Cache

Server is idle
Client is idle

@Client
0 is send
Client -> Server@+25 : GET
+25 is await
+75 is recv
+25 is idle
+25 is send
Client -> Server@+25 : GET\nIf-Modified-Since: 150
+25 is await
+50 is recv
+25 is idle
@100 <-> @275 : no need to re-request from server

@Server
25 is recv
+25 is work
+25 is send
Server -> Client@+25 : 200 OK\nExpires: 275
+25 is idle
+75 is recv
+25 is send
Server -> Client@+25 : 304 Not Modified
+25 is idle

@Cache
75 is fresh
+200 is stale
@enduml

```



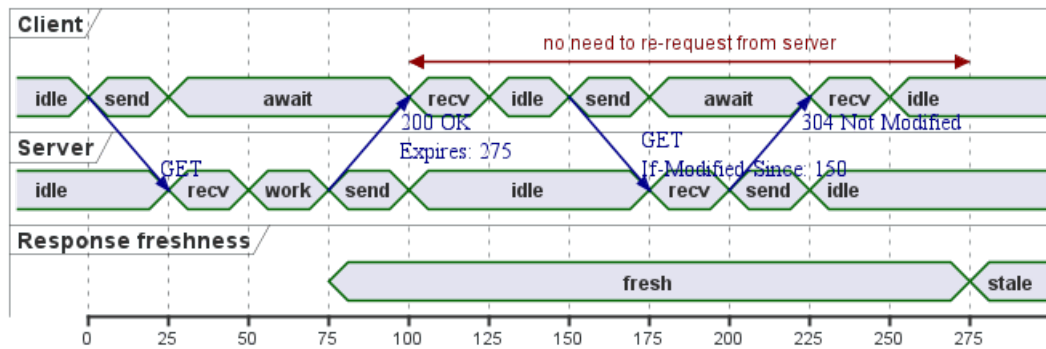

10.18 Exemple numérique

```
@startuml
scale 5 as 150 pixels

clock clk with period 1
binary "enable" as en
binary "R/W" as rw
binary "data Valid" as dv
concise "dataBus" as db
concise "address bus" as addr
```

```
@6 as :write_beg
@10 as :write_end
```

```
@15 as :read_beg
@19 as :read_end
```

```
@0
en is low
db is "0x0"
addr is "0x03f"
rw is low
dv is 0
```

```
@:write_beg-3
  en is high
@:write_beg-2
  db is "0xDEADBEEF"
@:write_beg-1
  dv is 1
@:write_beg
  rw is high
```

```
@:write_end
  rw is low
  dv is low
@:write_end+1
  rw is low
  db is "0x0"
  addr is "0x23"
```

```
@12
  dv is high
```



```

@13
db is "0xFFFF"

@20
en is low
dv is low
@21
db is "0x0"

highlight :write_beg to :write_end #Gold:Write
highlight :read_beg to :read_end #lightBlue:Read

db@:write_beg-1 <-> @:write_end : setup time
db@:write_beg-1 -> addr@:write_end+1 : hold
@enduml

```

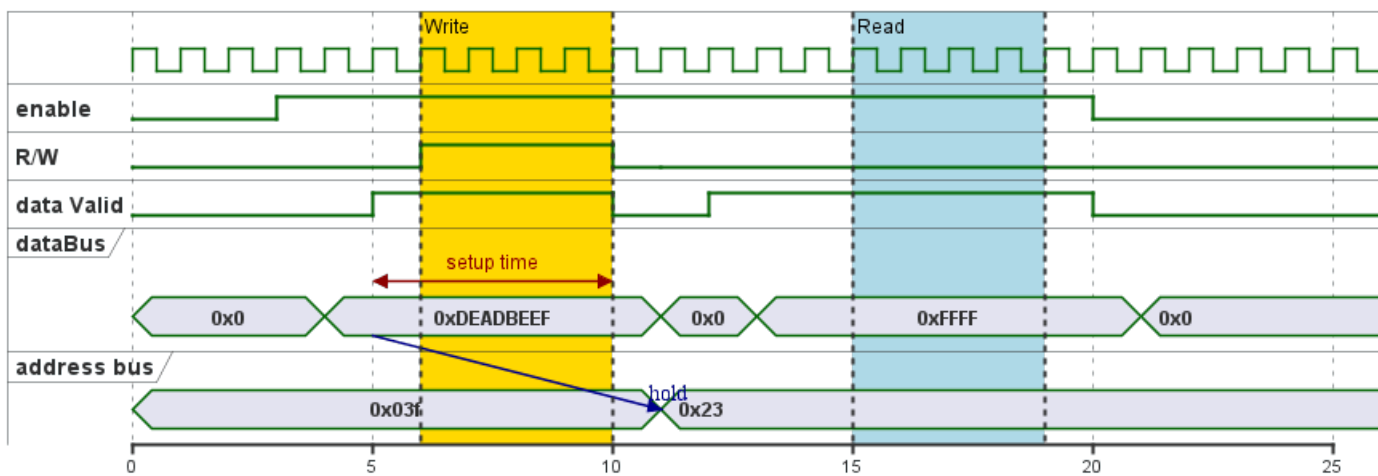

10.19 Ajout de couleur

Vous pouvez ajouter de la couleur

```

@startuml
concise "LR" as LR
concise "ST" as ST

LR is AtPlace #palegreen
ST is AtLoad #gray

@LR
0 is Lowering
100 is Lowered #pink
350 is Releasing

@ST
200 is Moving
@enduml

```



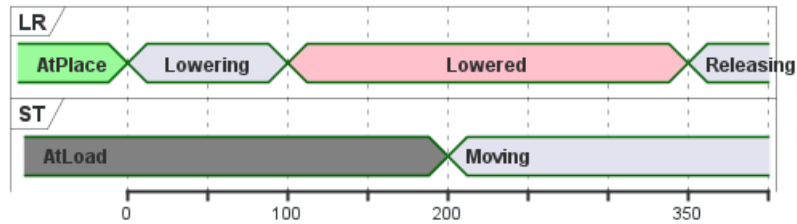

[Réf. QA-5776]

10.20 Using (global) style

10.20.1 Without style (by default)

```
@startuml
robust "Web Browser" as WB
concise "Web User" as WU
```

```
WB is Initializing
WU is Absent
```

```
@WB
0 is idle
+200 is Processing
+100 is Waiting
WB@0 <-> @50 : {50 ms lag}
```

```
@WU
0 is Waiting
+500 is ok
@200 <-> @+150 : {150 ms}
@enduml
```

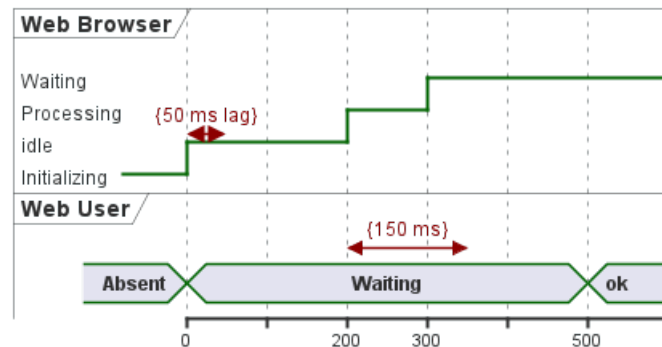

10.20.2 With style

You can use style to change rendering of elements.

```
@startuml
<style>
timingDiagram {
  document {
    BackGroundColor SandyBrown
  }
  constraintArrow {
   LineStyle 2-1
    LineThickness 3
    LineColor Blue
  }
}
```



```

}
}
</style>
robust "Web Browser" as WB
concise "Web User" as WU

WB is Initializing
WU is Absent

@WB
0 is idle
+200 is Processing
+100 is Waiting
WB@0 <-> @50 : {50 ms lag}

@WU
0 is Waiting
+500 is ok
@200 <-> @+150 : {150 ms}
@enduml

```

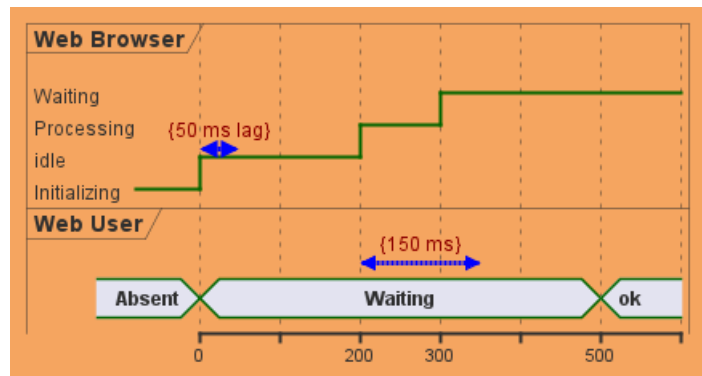

[Ref. QA-14340]

10.21 Applying Colors to specific lines

You can use the <style> tags and stereotyping to give a name to line attributes.

```

@startuml
<style>
timingDiagram {
  .red {
    LineColor red
  }
  .blue {
    LineColor blue
    LineThickness 5
  }
}
</style>

clock clk with period 1
binary "Input Signal 1" as IS1
binary "Input Signal 2" as IS2 <<blue>>
binary "Output Signal 1" as OS1 <<red>>

@0
IS1 is low

```



```

IS2 is high
OS1 is low
@2
OS1 is high
@4
OS1 is low
@5
IS1 is high
OS1 is high
@6
IS2 is low
@10
IS1 is low
OS1 is low
@enduml

```

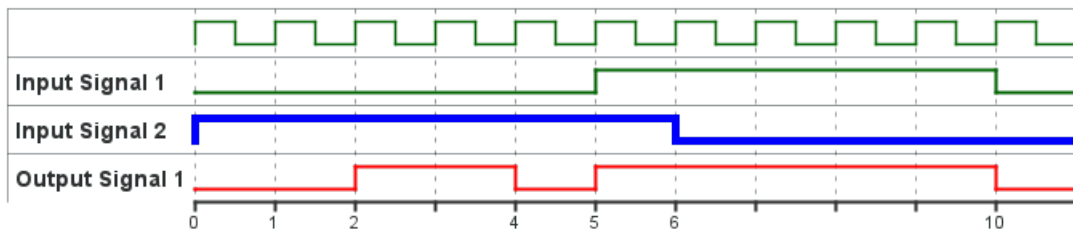

[Ref. QA-15870]

10.22 Compact mode

You can use compact command to compact the timing layout.

10.22.1 By default

```

@startuml
robust "Web Browser" as WB
concise "Web User" as WU
robust "Web Browser2" as WB2

@0
WU is Waiting
WB is Idle
WB2 is Idle

@200
WB is Proc.

@300
WB is Waiting
WB2 is Waiting

@500
WU is ok

@700
WB is Idle
@enduml

```



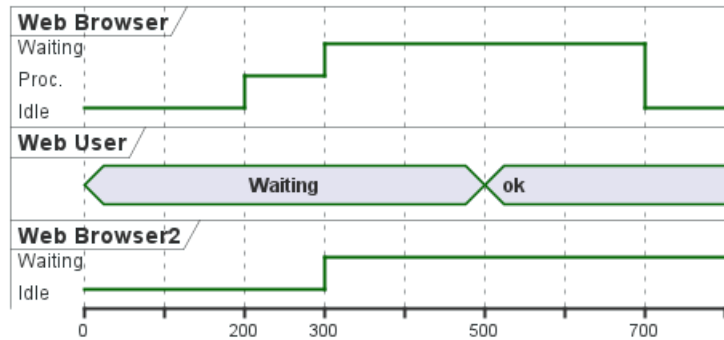

10.22.2 Global mode with mode compact

```
@startuml
mode compact
robust "Web Browser" as WB
concise "Web User" as WU
robust "Web Browser2" as WB2
```

```
@0
WU is Waiting
WB is Idle
WB2 is Idle
```

```
@200
WB is Proc.
```

```
@300
WB is Waiting
WB2 is Waiting
```

```
@500
WU is ok
```

```
@700
WB is Idle
@enduml
```

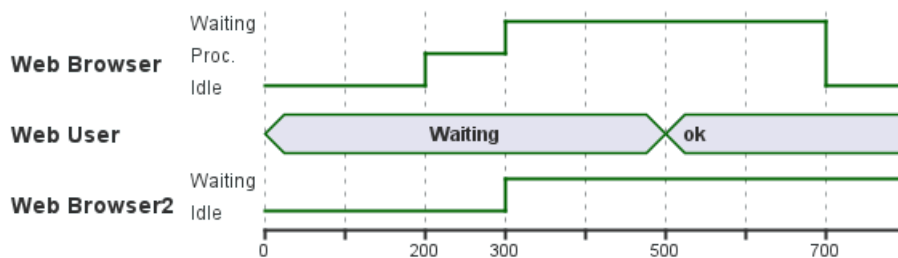

10.22.3 Local mode with only compact on element

```
@startuml
compact robust "Web Browser" as WB
compact concise "Web User" as WU
robust "Web Browser2" as WB2
```

```
@0
WU is Waiting
WB is Idle
```



```

WB2 is Idle

@200
WB is Proc.

@300
WB is Waiting
WB2 is Waiting

@500
WU is ok

@700
WB is Idle
@enduml
    
```

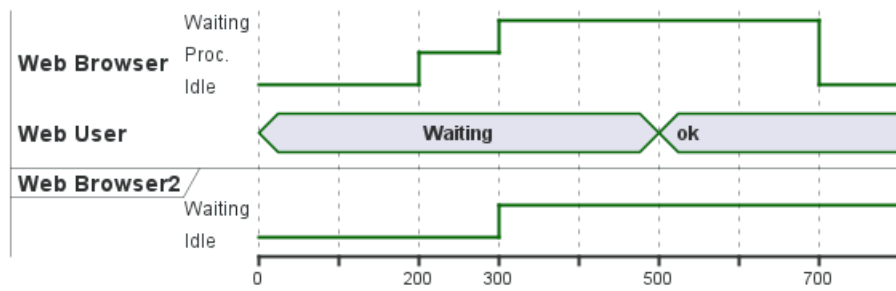

[Ref. QA-11130]

11 Display JSON Data

JSON format is widely used in software.

You can use PlantUML to visualize your data.

To activate this feature, the diagram must:

- begin with `@startjson` keyword
- end with `@endjson` keyword.

```
@startjson
{
  "fruit": "Apple",
  "size": "Large",
  "color": ["Red", "Green"]
}
@endjson
```

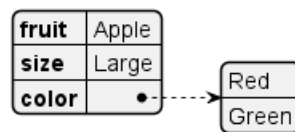

11.1 Complex example

You can use complex JSON structure.

```
@startjson
{
  "firstName": "John",
  "lastName": "Smith",
  "isAlive": true,
  "age": 27,
  "address": {
    "streetAddress": "21 2nd Street",
    "city": "New York",
    "state": "NY",
    "postalCode": "10021-3100"
  },
  "phoneNumbers": [
    {
      "type": "home",
      "number": "212 555-1234"
    },
    {
      "type": "office",
      "number": "646 555-4567"
    }
  ],
  "children": [],
  "spouse": null
}
@endjson
```



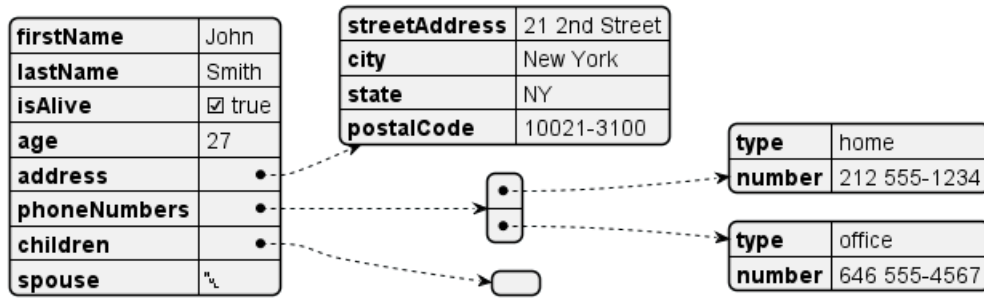

11.2 Highlight parts

```
@startjson
#highlight "lastName"
#highlight "address" / "city"
#highlight "phoneNumbers" / "0" / "number"
{
  "firstName": "John",
  "lastName": "Smith",
  "isAlive": true,
  "age": 28,
  "address": {
    "streetAddress": "21 2nd Street",
    "city": "New York",
    "state": "NY",
    "postalCode": "10021-3100"
  },
  "phoneNumbers": [
    {
      "type": "home",
      "number": "212 555-1234"
    },
    {
      "type": "office",
      "number": "646 555-4567"
    }
  ],
  "children": [],
  "spouse": null
}
@endjson
```

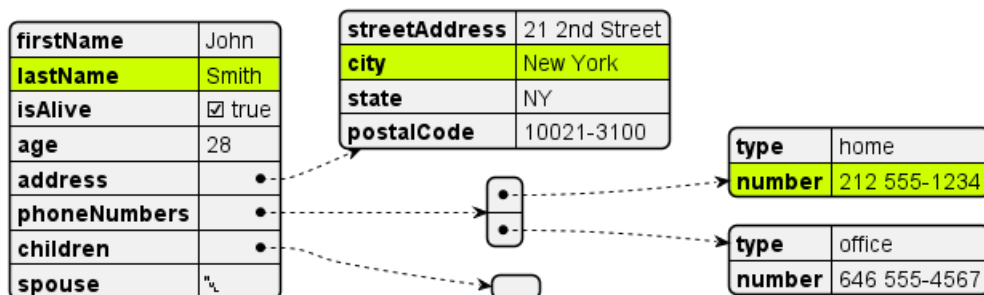

11.3 Using different styles for highlight

It is possible to have different styles for different highlights.

```
@startjson
```



```

<style>
  .h1 {
    BackGroundColor green
    FontColor white
    FontStyle italic
  }
  .h2 {
    BackGroundColor red
    FontColor white
    FontStyle bold
  }
</style>
#highlight "lastName"
#highlight "address" / "city" <<h1>>
#highlight "phoneNumbers" / "0" / "number" <<h2>>
{
  "firstName": "John",
  "lastName": "Smith",
  "isAlive": true,
  "age": 28,
  "address": {
    "streetAddress": "21 2nd Street",
    "city": "New York",
    "state": "NY",
    "postalCode": "10021-3100"
  },
  "phoneNumbers": [
    {
      "type": "home",
      "number": "212 555-1234"
    },
    {
      "type": "office",
      "number": "646 555-4567"
    }
  ],
  "children": [],
  "spouse": null
}
@endjson

```

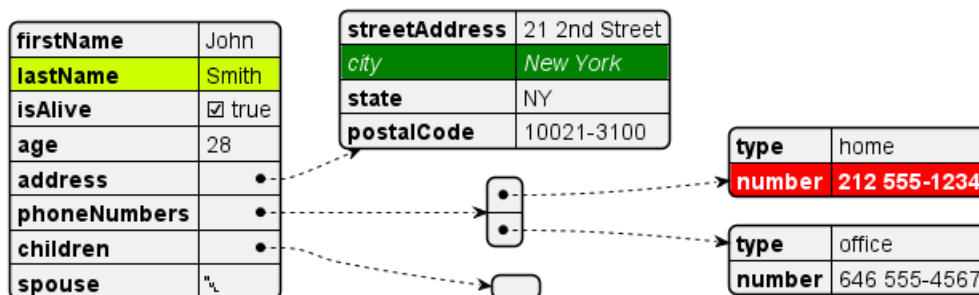

[Ref. QA-15756, GH-1393]

11.4 JSON basic element

11.4.1 Synthesis of all JSON basic element

```

@startjson
{

```



```

>null": null,
>true": true,
>false": false,
>JSON_Number": [-1, -1.1, "<color:green>TBC"],
>JSON_String": "a\nb\rc\td <color:green>TBC...",
>JSON_Object": {
>  "{}": {},
>  "k_int": 123,
>  "k_str": "abc",
>  "k_obj": {"k": "v"}
>},
>JSON_Array" : [
>  [],
>  [true, false],
>  [-1, 1],
>  ["a", "b", "c"],
>  ["mix", null, true, 1, {"k": "v"}]
>]
>}
>@endjson

```

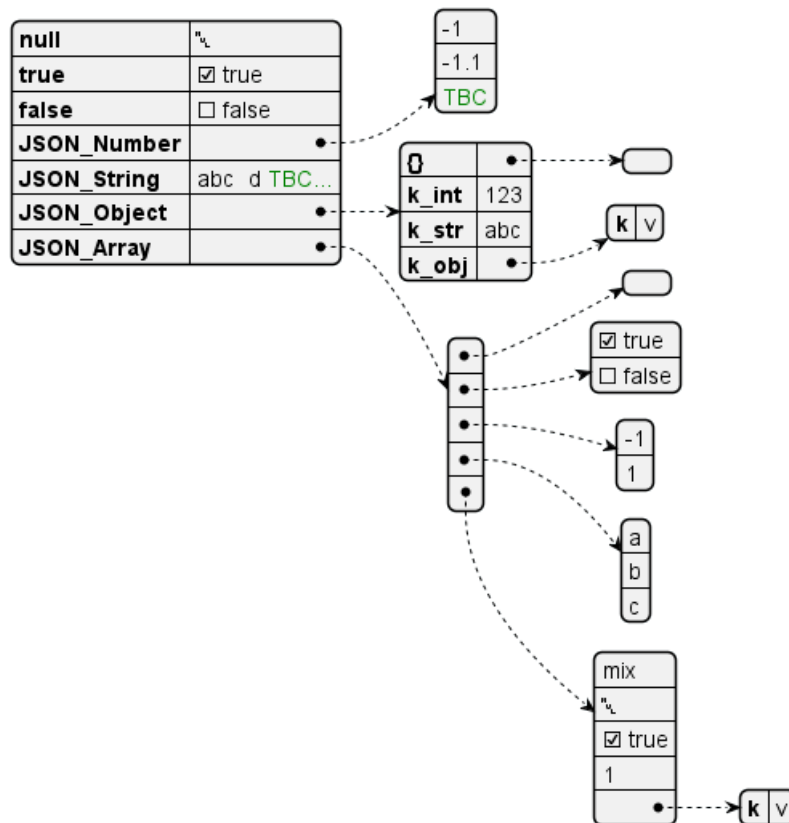

11.5 JSON array or table

11.5.1 Array type

```

>@startjson
>{
>  "Numeric": [1, 2, 3],
>  "String " : ["v1a", "v2b", "v3c"],
>  "Boolean": [true, false, true]
>}
>@endjson

```



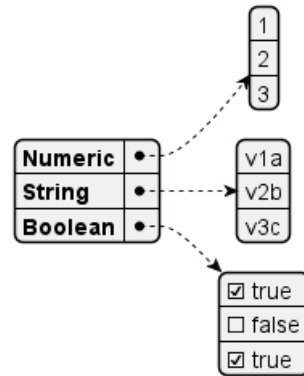

11.5.2 Minimal array or table

11.5.3 Number array

```
@startjson
[1, 2, 3]
@endjson
```

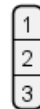

11.5.4 String array

```
@startjson
["1a", "2b", "3c"]
@endjson
```

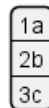

11.5.5 Boolean array

```
@startjson
[true, false, true]
@endjson
```

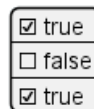

11.6 JSON numbers

```
@startjson
{
  "DecimalNumber": [-1, 0, 1],
  "DecimalNumber . Digits": [-1.1, 0.1, 1.1],
  "DecimalNumber ExponentPart": [1E5]
}
@endjson
```

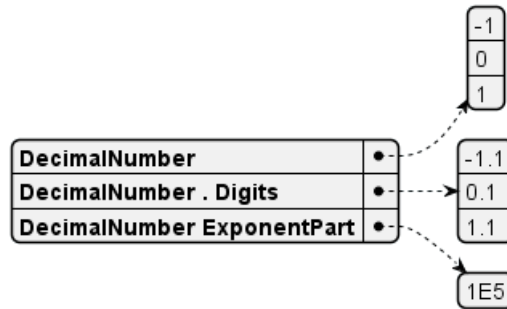

11.7 JSON strings

11.7.1 JSON Unicode

On JSON you can use Unicode directly or by using escaped form like .

```
@startjson
{
  "<color:blue><b>code": "<color:blue><b>value",
  "a\u005Cb":      "a\u005Cb",
  "\uD83D\uDE10": "\uD83D\uDE10",
  " ":              " "
}
@endjson
```

code	value
a\u005Cb	a\b
\uD83D\uDE10	👹

11.7.2 JSON two-character escape sequence

```
@startjson
{
  "**legend**: character name":      ["**two-character escape sequence**", "example (between
  "quotation mark character (U+0022)": ["\\\"", "a\"b"],
  "reverse solidus character (U+005C)": ["\\\\", "a\\b"],
  "solidus character (U+002F)":       ["\\/", "a\/b"],
  "backspace character (U+0008)":     ["\\b", "a\\bb"],
  "form feed character (U+000C)":     ["\\f", "a\\fb"],
  "line feed character (U+000A)":     ["\\n", "a\\nb"],
  "carriage return character (U+000D)": ["\\r", "a\\rb"],
  "character tabulation character (U+0009)": ["\\t", "a\\tb"]
}
@endjson
```



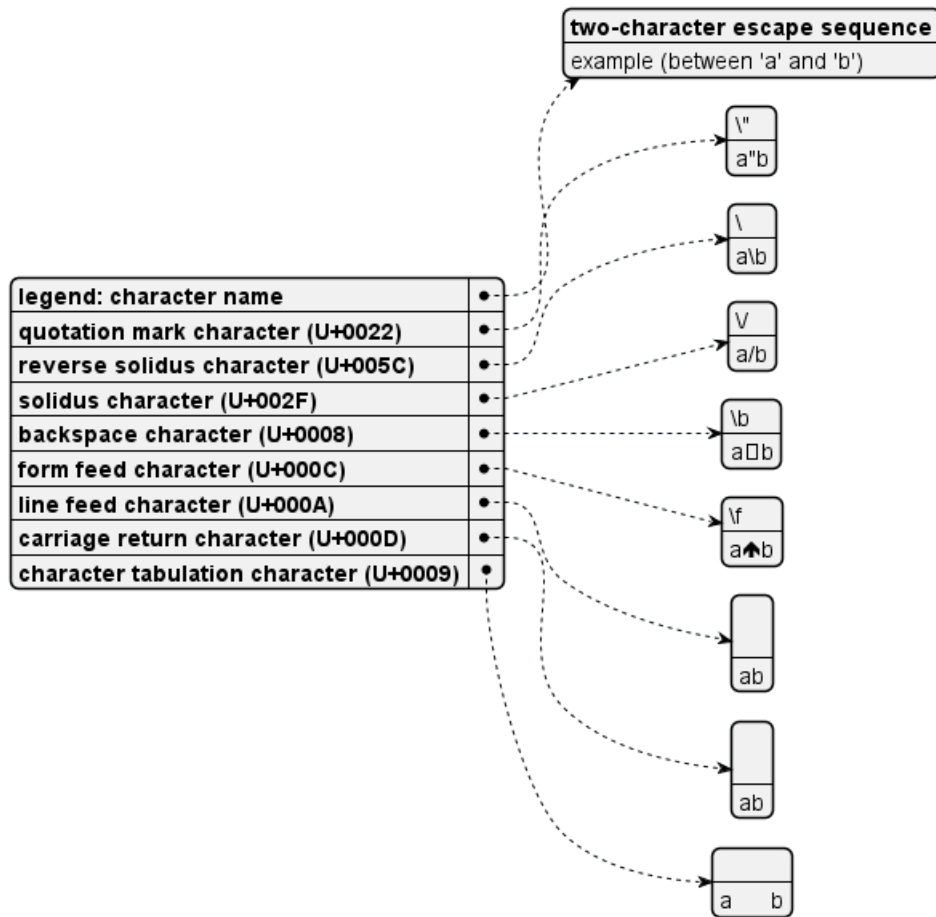

TODO: FIXME FIXME or not , on the same item as management in PlantUML See Report Bug on QA-13066 **TODO:** FIXME

```
@startjson
[
  "\\\\",
  "\\n",
  "\\r",
  "\\t"
]
@endjson
```

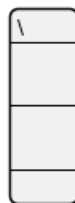

11.8 Minimal JSON examples

```
@startjson
"Hello world!"
@endjson
```

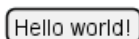

```
@startjson
42
@endjson
```

```
@startjson
true
@endjson
```

(Examples come from STD 90 - Examples)

11.9 Empty table or list

```
@startjson
{
  "empty_tab": [],
  "empty_list": {}
}
@endjson
```



[Ref. QA-14397]

11.10 Using (global) style

11.10.1 Without style (by default)

```
@startjson
#highlight "1" / "hr"
[
  {
    "name": "Mark McGwire",
    "hr": 65,
    "avg": 0.278
  },
  {
    "name": "Sammy Sosa",
    "hr": 63,
    "avg": 0.288
  }
]
@endjson
```

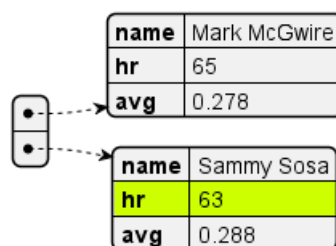

11.10.2 With style

You can use style to change rendering of elements.

```
@startjson
<style>
jsonDiagram {
  node {
    BackGroundColor Khaki
    LineColor lightblue
    FontName Helvetica
    FontColor red
    FontSize 18
    FontStyle bold
    RoundCorner 0
    LineThickness 2
    LineStyle 10-5
    separator {
      LineThickness 0.5
      LineColor black
      LineStyle 1-5
    }
  }
  arrow {
    BackGroundColor lightblue
    LineColor green
    LineThickness 2
    LineStyle 2-5
  }
  highlight {
    BackGroundColor red
    FontColor white
    FontStyle italic
  }
}
</style>
#highlight "1" / "hr"
[
  {
    "name": "Mark McGwire",
    "hr": 65,
    "avg": 0.278
  },
  {
    "name": "Sammy Sosa",
    "hr": 63,
    "avg": 0.288
  }
]
@endjson
```

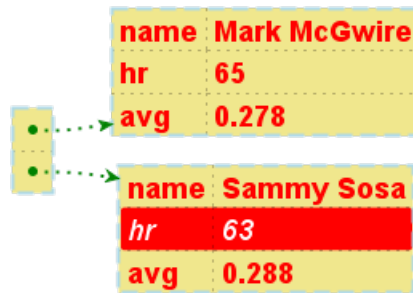

[Adapted from QA-13123 and QA-13288]

11.11 Display JSON Data on Class or Object diagram

11.11.1 Simple example

```
@startuml
class Class
object Object
json JSON {
  "fruit": "Apple",
  "size": "Large",
  "color": ["Red", "Green"]
}
@enduml
```

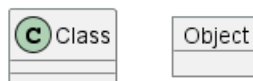

JSON	
fruit	Apple
size	Large
color	Red
	Green

[Ref. QA-15481]

11.11.2 Complex example: with all JSON basic element

```
@startuml
json "<b>JSON basic element" as J {
  "null": null,
  "true": true,
  "false": false,
  "JSON_Number": [-1, -1.1, "<color:green>TBC"],
  "JSON_String": "\n\n\t\t <color:green>TBC...",
  "JSON_Object": {
    "{}": {},
    "k_int": 123,
    "k_str": "abc",
    "k_obj": {"k": "v"}
  },
  "JSON_Array" : [
    [],
    [true, false],
    [-1, 1],
  ]
}
```



```

["a", "b", "c"],
["mix", null, true, 1, {"k": "v"}]
]
}
@enduml

```

JSON basic element	
null	null
true	true
false	false
JSON_Number	-1
	-1.1
	TBC
JSON_String	abc d TBC...
JSON_Object	{}
	k_int 123
	k_str abc
	k_obj k v
JSON_Array	true
	false
	-1
	1
	a
	b
	c
	mix
	null
	true
	1
	k v

11.12 Display JSON Data on Deployment (Usecase, Component, Deployment) diagram

11.12.1 Simple example

```

@startuml
allowmixing

component Component
actor Actor
usecase Usecase
() Interface
node Node
cloud Cloud

json JSON {
    "fruit": "Apple",
    "size": "Large",
    "color": ["Red", "Green"]
}
@enduml

```

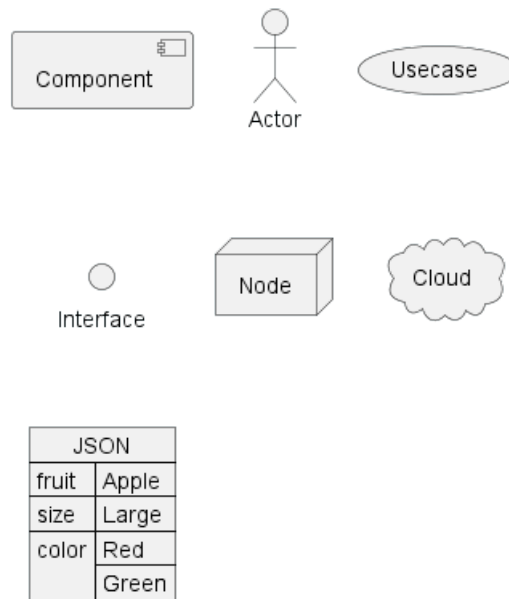

[Ref. QA-15481]

Complex example: with arrow

```

@startuml
allowmixing

agent Agent
stack {
  json "JSON_file.json" as J {
    "fruit":"Apple",
    "size":"Large",
    "color": ["Red", "Green"]
  }
}
database Database

Agent -> J
J -> Database
@enduml

```

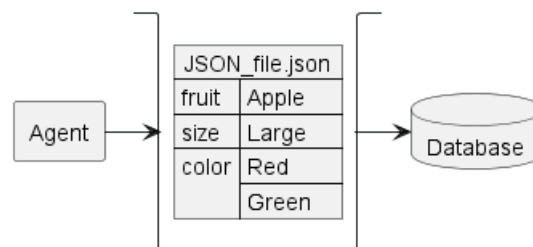

11.13 Display JSON Data on State diagram

11.13.1 Simple example

```

@startuml
state "A" as stateA
state "C" as stateC {
  state B
}

```



```
json J {  
    "fruit": "Apple",  
    "size": "Large",  
    "color": ["Red", "Green"]  
}  
@enduml
```

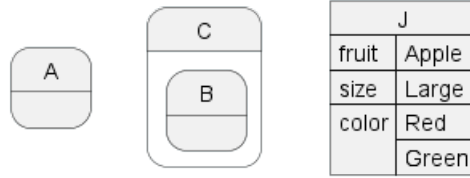

[Ref. QA-17275]

12 Display YAML Data

YAML format is widely used in software.

You can use PlantUML to visualize your data.

To activate this feature, the diagram must:

- begin with `@startyaml` keyword
- end with `@endyaml` keyword.

```
@startyaml
fruit: Apple
size: Large
color:
  - Red
  - Green
@endyaml
```

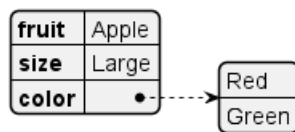

12.1 Complex example

```
@startyaml
doe: "a deer, a female deer"
ray: "a drop of golden sun"
pi: 3.14159
xmas: true
french-hens: 3
calling-birds:
  - huey
  - dewey
  - louie
  - fred
xmas-fifth-day:
calling-birds: four
french-hens: 3
golden-rings: 5
partridges:
count: 1
location: "a pear tree"
turtle-doves: two
@endyaml
```

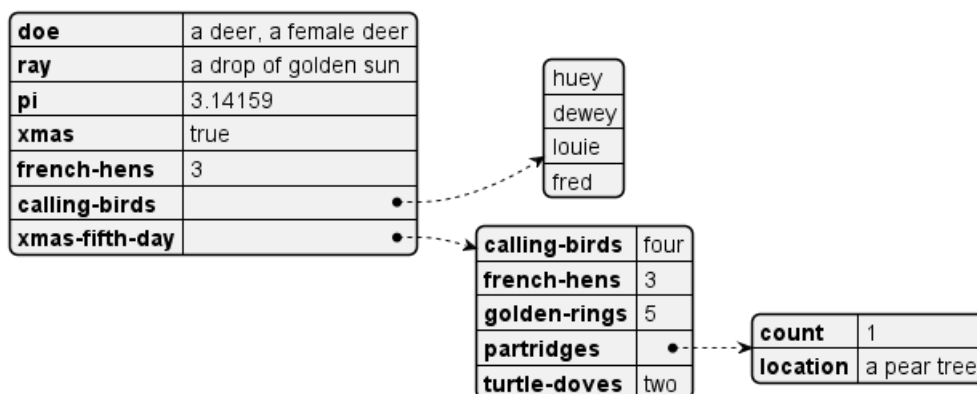

12.2 Specific key (with symbols or unicode)

```
@startyaml
@fruit: Apple
$size: Large
&color: Red
♥: Heart
%: Per mille
@endyaml
```

@fruit	Apple
\$size	Large
&color	Red
♥	Heart
%	Per mille

[Ref. QA-13376]

12.3 Highlight parts

12.3.1 Normal style

```
@startyaml
#highlight "french-hens"
#highlight "xmas-fifth-day" / "partridges"
```

```
doe: "a deer, a female deer"
ray: "a drop of golden sun"
pi: 3.14159
xmas: true
french-hens: 3
calling-birds:
- huey
- dewey
- louie
- fred
xmas-fifth-day:
calling-birds: four
french-hens: 3
golden-rings: 5
partridges:
count: 1
location: "a pear tree"
turtle-doves: two
@endyaml
```

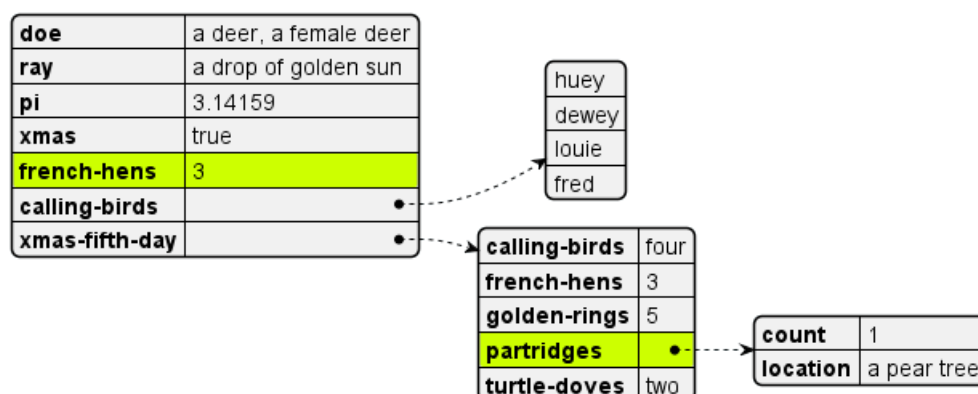

12.3.2 Customised style

```

@startyaml
<style>
yamlDiagram {
  highlight {
    BackgroundColor red
    FontColor white
    FontStyle italic
  }
}
</style>
#highlight "french-hens"
#highlight "xmas-fifth-day" / "partridges"

doe: "a deer, a female deer"
ray: "a drop of golden sun"
pi: 3.14159
xmas: true
french-hens: 3
calling-birds:
- huey
- dewey
- louie
- fred
xmas-fifth-day:
calling-birds: four
french-hens: 3
golden-rings: 5
partridges:
count: 1
location: "a pear tree"
turtle-doves: two
@endyaml

```

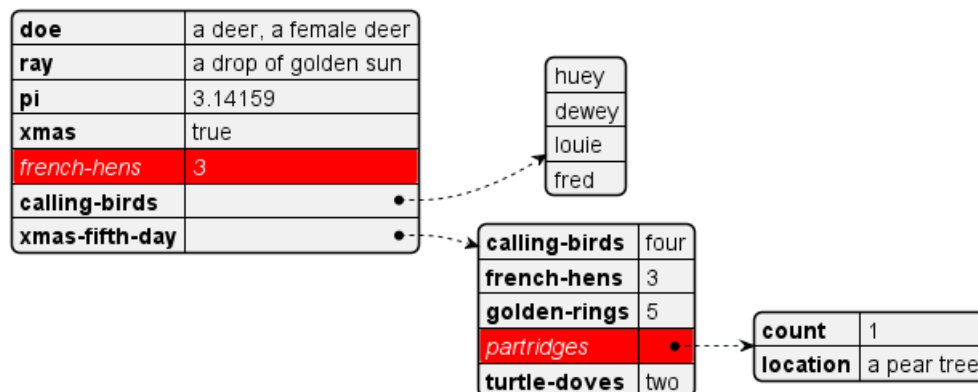

[Ref. QA-13288]

12.4 Using different styles for highlight

It is possible to have different styles for different highlights.

```

@startyaml
<style>
.h1 {
  BackgroundColor green
  FontColor white
}

```



```

    FontStyle italic
  }
  .h2 {
    BackGroundColor red
    FontColor white
    FontStyle italic
  }
</style>
#highlight "french-hens" <<h1>>
#highlight "xmas-fifth-day" / "partridges" <<h2>>

doe: "a deer, a female deer"
ray: "a drop of golden sun"
pi: 3.14159
xmas: true
french-hens: 3
calling-birds:
- huey
- dewey
- louie
- fred
xmas-fifth-day:
calling-birds: four
french-hens: 3
golden-rings: 5
partridges:
count: 1
location: "a pear tree"
turtle-doves: two
@endyaml

```

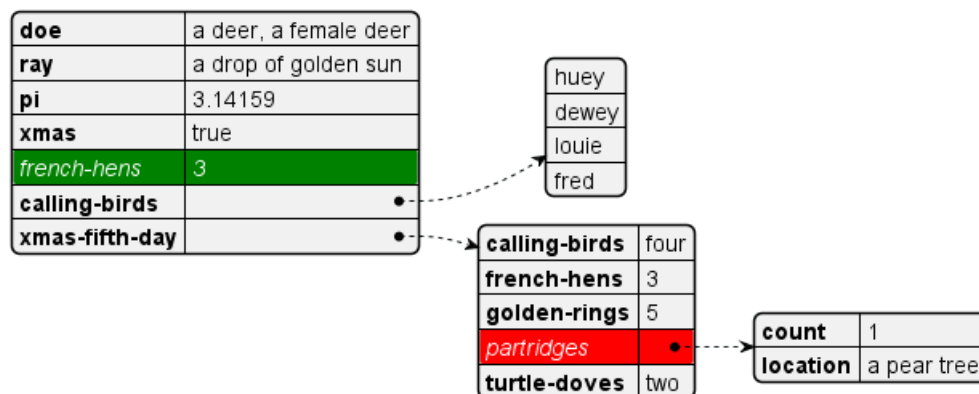

[Ref. QA-15756, GH-1393]

12.5 Using (global) style

12.5.1 Without style (by default)

```

@startyaml
-
  name: Mark McGwire
  hr: 65
  avg: 0.278
-
  name: Sammy Sosa
  hr: 63

```



```

    avg: 0.288
@endyaml

```

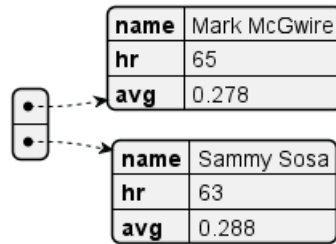

12.5.2 With style

You can use style to change rendering of elements.

```

@startyaml
<style>
yamlDiagram {
  node {
    BackGroundColor lightblue
    LineColor lightblue
    FontName Helvetica
    FontColor red
    FontSize 18
    FontStyle bold
    BackGroundColor Khaki
    RoundCorner 0
    LineThickness 2
    LineStyle 10-5
    separator {
      LineThickness 0.5
      LineColor black
      LineStyle 1-5
    }
  }
  arrow {
    BackGroundColor lightblue
    LineColor green
    LineThickness 2
    LineStyle 2-5
  }
}
</style>
-
  name: Mark McGwire
  hr: 65
  avg: 0.278
-
  name: Sammy Sosa
  hr: 63
  avg: 0.288
@endyaml

```



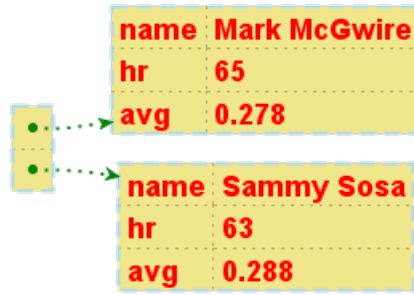

[Ref. QA-13123]

13 nwdiag

nwdiag a été écrit par Takeshi Komiya. Ce programme permet de décrire rapidement des diagrammes de réseaux. Merci beaucoup à lui pour sa création!

Puisque la syntaxe est simple et clair, celle-ci a été intégrée à PlantUML. Nous réutilisons ici les exemples que Takeshi a utilisés.

13.1 Diagramme simple

13.1.1 Définir un réseau

```
@startuml
nwdiag {
  network dmz {
    address = "210.x.x.x/24"
  }
}
@enduml
```

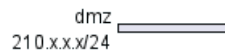

13.1.2 Définir certains éléments ou serveurs sur un réseau

```
@startuml
nwdiag {
  network dmz {
    address = "210.x.x.x/24"

    web01 [address = "210.x.x.1"];
    web02 [address = "210.x.x.2"];
  }
}
@enduml
```

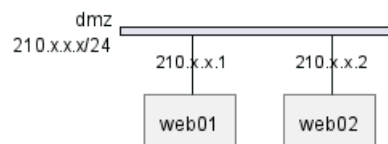

13.1.3 Exemple complet

```
@startuml
nwdiag {
  network dmz {
    address = "210.x.x.x/24"

    web01 [address = "210.x.x.1"];
    web02 [address = "210.x.x.2"];
  }
  network internal {
    address = "172.x.x.x/24";

    web01 [address = "172.x.x.1"];
    web02 [address = "172.x.x.2"];
  }
}
```



```

    db01;
    db02;
  }
}
@enduml

```

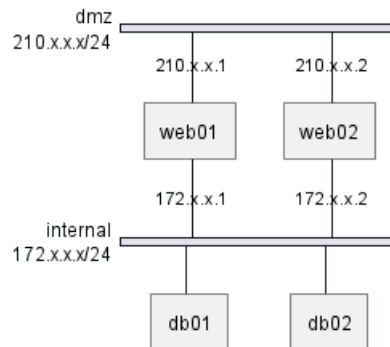

13.2 Define multiple addresses

```

@startuml
nwdiag {
  network dmz {
    address = "210.x.x.x/24"

    // set multiple addresses (using comma)
    web01 [address = "210.x.x.1, 210.x.x.20"];
    web02 [address = "210.x.x.2"];
  }
  network internal {
    address = "172.x.x.x/24";

    web01 [address = "172.x.x.1"];
    web02 [address = "172.x.x.2"];
    db01;
    db02;
  }
}
@enduml

```

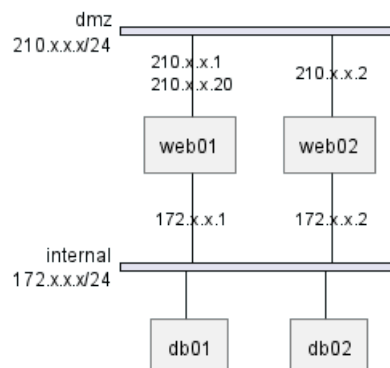

13.3 Grouping nodes

13.3.1 Define group inside network definitions

```
@startuml
nwdiag {
  network Sample_front {
    address = "192.168.10.0/24";

    // define group
    group web {
      web01 [address = ".1"];
      web02 [address = ".2"];
    }
  }
  network Sample_back {
    address = "192.168.20.0/24";
    web01 [address = ".1"];
    web02 [address = ".2"];
    db01 [address = ".101"];
    db02 [address = ".102"];

    // define network using defined nodes
    group db {
      db01;
      db02;
    }
  }
}
@enduml
```

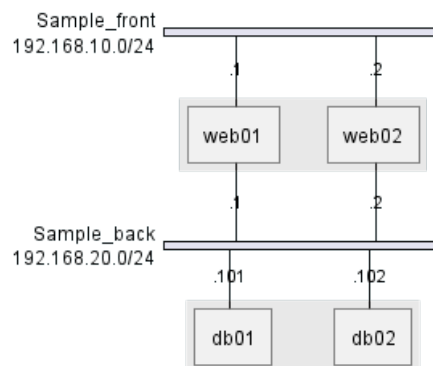

13.3.2 Define group outside of network definitions

```
@startuml
nwdiag {
  // define group outside of network definitions
  group {
    color = "#FFAAAA";

    web01;
    web02;
    db01;
  }

  network dmz {
```



```

    web01;
    web02;
  }
  network internal {
    web01;
    web02;
    db01;
    db02;
  }
}
@enduml

```

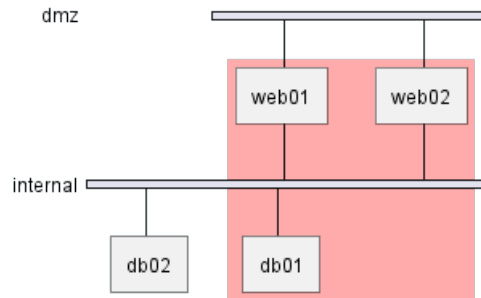

13.3.3 Define several groups on same network

13.3.4 Example with 2 group

```

@startuml
nwdiag {
  group {
    color = "#FFaaaa";
    web01;
    db01;
  }
  group {
    color = "#aaaaFF";
    web02;
    db02;
  }
  network dmz {
    address = "210.x.x.x/24"

    web01 [address = "210.x.x.1"];
    web02 [address = "210.x.x.2"];
  }
  network internal {
    address = "172.x.x.x/24";

    web01 [address = "172.x.x.1"];
    web02 [address = "172.x.x.2"];
    db01 ;
    db02 ;
  }
}
@enduml

```



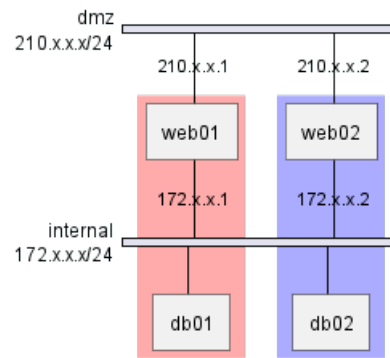

[Ref. QA-12663]

13.3.5 Example with 3 groups

```

@startuml
nwdiag {
  group {
    color = "#FFaaaa";
    web01;
    db01;
  }
  group {
    color = "#aaFFaa";
    web02;
    db02;
  }
  group {
    color = "#aaaaFF";
    web03;
    db03;
  }

  network dmz {
    web01;
    web02;
    web03;
  }
  network internal {
    web01;
    db01 ;
    web02;
    db02 ;
    web03;
    db03;
  }
}
@enduml
  
```



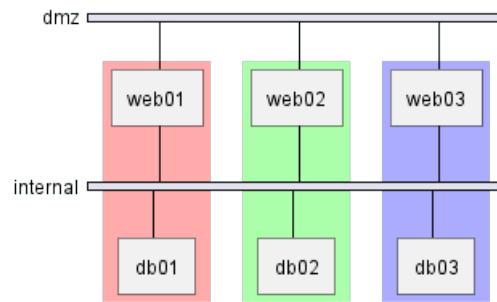

[Ref. QA-13138]

13.4 Extended Syntax (for network or group)

13.4.1 Network

For network or network's component, you can add or change:

- addresses (*separated by comma ,*);
- color;
- description;
- shape.

```
@startuml
nwdiag {
  network Sample_front {
    address = "192.168.10.0/24"
    color = "red"

    // define group
    group web {
      web01 [address = ".1, .2", shape = "node"]
      web02 [address = ".2, .3"]
    }
  }
  network Sample_back {
    address = "192.168.20.0/24"
    color = "palegreen"
    web01 [address = ".1"]
    web02 [address = ".2"]
    db01 [address = ".101", shape = database ]
    db02 [address = ".102"]

    // define network using defined nodes
    group db {
      db01;
      db02;
    }
  }
}
@enduml
```



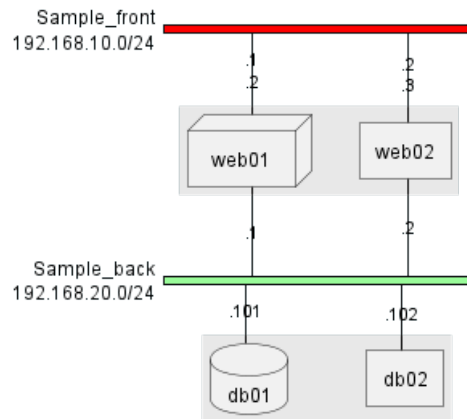

13.4.2 Group

For a group, you can add or change:

- color;
- description.

```
@startuml
nwdiag {
  group {
    color = "#CCFFCC";
    description = "Long group description";

    web01;
    web02;
    db01;
  }

  network dmz {
    web01;
    web02;
  }

  network internal {
    web01;
    web02;
    db01 [address = ".101", shape = database];
  }
}
@enduml
```

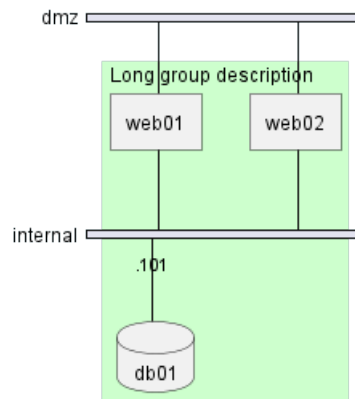

[Ref. QA-12056]

13.5 Using Sprites

You can use all sprites (icons) from the Standard Library or any other library.

Use the notation `<$sprite>` to use a sprite, to make a new line, or any other Creole syntax.

```
@startuml
!include <office/Servers/application_server>
!include <office/Servers/database_server>

nwdiag {
  network dmz {
    address = "210.x.x.x/24"

    // set multiple addresses (using comma)
    web01 [address = "210.x.x.1, 210.x.x.20", description = "<$application_server>\n web01"]
    web02 [address = "210.x.x.2", description = "<$application_server>\n web02"];
  }
  network internal {
    address = "172.x.x.x/24";

    web01 [address = "172.x.x.1"];
    web02 [address = "172.x.x.2"];
    db01 [address = "172.x.x.100", description = "<$database_server>\n db01"];
    db02 [address = "172.x.x.101", description = "<$database_server>\n db02"];
  }
}
@enduml
```

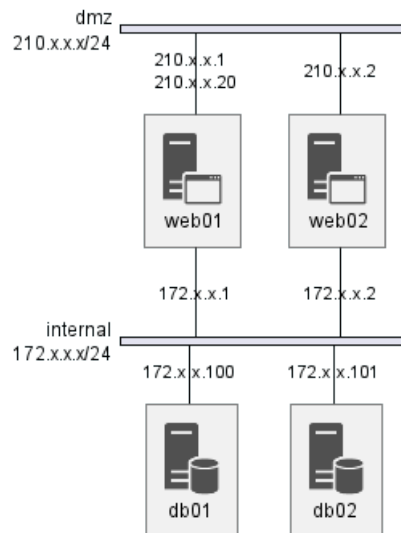

[Ref. QA-11862]

13.6 Using OpenIconic

You can also use the icons from OpenIconic in network or node descriptions.

Use the notation `<&icon>` to make an icon, `<&icon*n>` to multiply the size by a factor `n`, and `\n` to make a newline:

```
@startuml
nwdiag {
  group nightly {
    color = "#FFAAAA";
    description = "<&clock> Restarted nightly <&clock>";
    web02;
    db01;
  }
  network dmz {
    address = "210.x.x.x/24"

    user [description = "<&person*4.5>\n user1"];
    // set multiple addresses (using comma)
    web01 [address = "210.x.x.1, 210.x.x.20", description = "<&cog*4>\nweb01"];
    web02 [address = "210.x.x.2", description = "<&cog*4>\nweb02"];

  }
  network internal {
    address = "172.x.x.x/24";

    web01 [address = "172.x.x.1"];
    web02 [address = "172.x.x.2"];
    db01 [address = "172.x.x.100", description = "<&spreadsheet*4>\n db01"];
    db02 [address = "172.x.x.101", description = "<&spreadsheet*4>\n db02"];
    ptr [address = "172.x.x.110", description = "<&print*4>\n ptr01"];
  }
}
@enduml
```



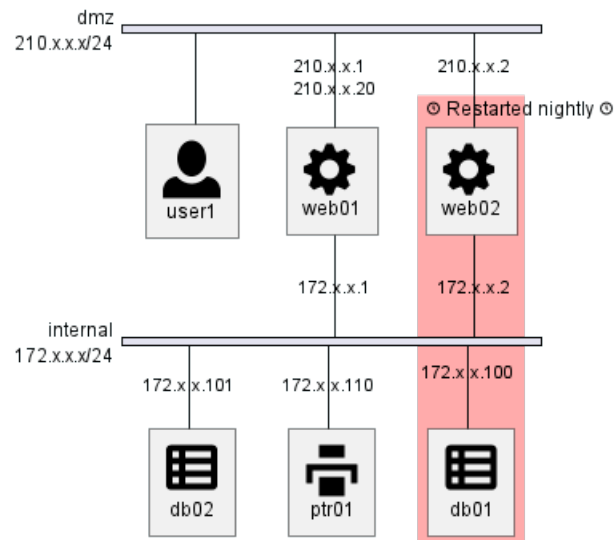

13.7 Same nodes on more than two networks

You can use same nodes on different networks (more than two networks); *nwdiag* use in this case 'jump line' over networks.

```
@startuml
nwdiag {
  // define group at outside network definitions
  group {
    color = "#7777FF";

    web01;
    web02;
    db01;
  }

  network dmz {
    color = "pink"

    web01;
    web02;
  }

  network internal {
    web01;
    web02;
    db01 [shape = database ];
  }

  network internal2 {
    color = "LightBlue";

    web01;
    web02;
    db01;
  }
}
}
```



```
@enduml
```

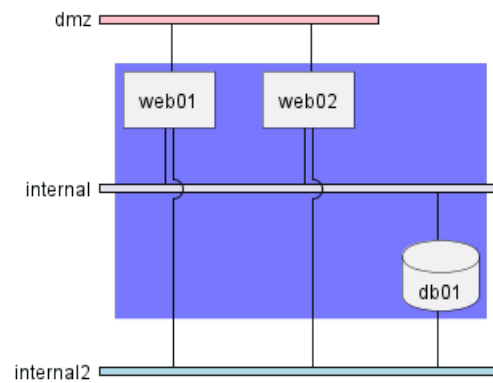

13.8 Peer networks

Peer networks are simple connections between two nodes, for which we don't use a horizontal "busbar" network

```
@startuml
nwdiag {
  inet [shape = cloud];
  inet -- router;

  network {
    router;
    web01;
    web02;
  }
}
@enduml
```

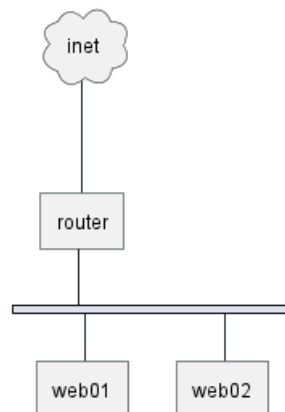

13.9 Peer networks and group

13.9.1 Without group

```
@startuml
nwdiag {
  internet [ shape = cloud];
```



```

internet -- router;

network proxy {
    router;
    app;
}
network default {
    app;
    db;
}
}
@enduml

```

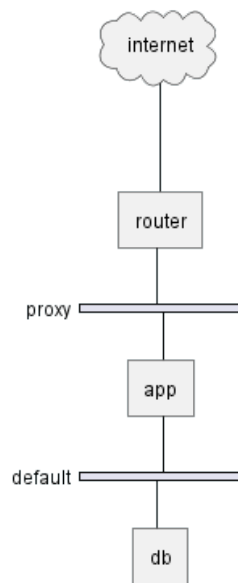

13.9.2 Group on first

```

@startuml
nwdiag {
    internet [ shape = cloud];
    internet -- router;

    group {
        color = "pink";
        app;
        db;
    }

    network proxy {
        router;
        app;
    }

    network default {
        app;
        db;
    }
}

```



```
@enduml
```

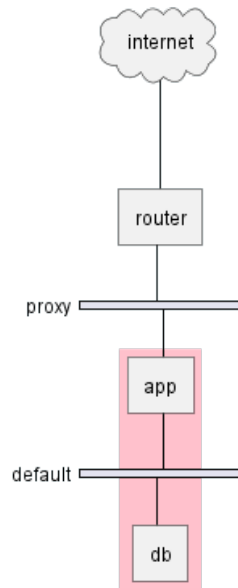

13.9.3 Group on second

```
@startuml
nwdiag {
  internet [ shape = cloud];
  internet -- router;

  network proxy {
    router;
    app;
  }

  group {
    color = "pink";
    app;
    db;
  }

  network default {
    app;
    db;
  }
}
@enduml
```

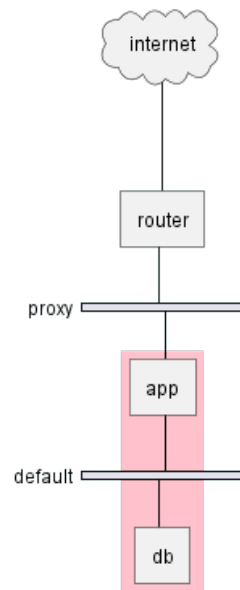

13.9.4 Group on third

```

@startuml
nwdiag {
    internet [ shape = cloud];
    internet -- router;

    network proxy {
        router;
        app;
    }
    network default {
        app;
        db;
    }
    group {
        color = "pink";
        app;
        db;
    }
}
@enduml

```

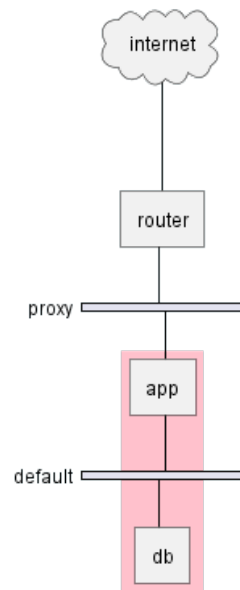

[Ref. Issue#408 and QA-12655]

13.10 Add title, caption, header, footer or legend on network diagram

```
@startuml
header some header
footer some footer
title My title
nwdiag {
  network inet {
    web01 [shape = cloud]
  }
}
legend
The legend
end legend
caption This is caption
@enduml
```

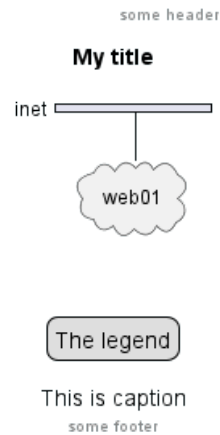

[Ref. QA-11303 and Common commands]

13.11 With or without shadow

13.11.1 With shadow (by default)

```
@startuml
nwdiag {
  network nw {
    server;
    internet;
  }
  internet [shape = cloud];
}
@enduml
```

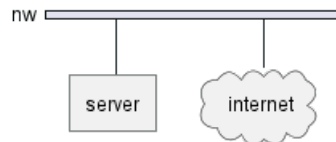

13.11.2 Without shadow

```
@startuml
<style>
root {
  shadowing 0
}
</style>
nwdiag {
  network nw {
    server;
    internet;
  }
  internet [shape = cloud];
}
@enduml
```

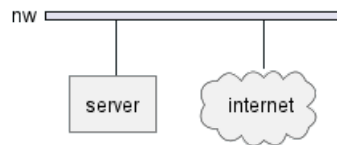

[Ref. QA-14516]

13.12 Change width of the networks

You can change the width of the networks, especially in order to have the same full width for only some or all networks.

Here are some examples, with all the possibilities:

- without

```
@startuml
nwdiag {
  network NETWORK_BASE {
    dev_A [address = "dev_A" ]
    dev_B [address = "dev_B" ]
  }
  network IntNET1 {
    dev_B [address = "dev_B1" ]
    dev_M [address = "dev_M1" ]
  }
  network IntNET2 {
    dev_B [address = "dev_B2" ]
    dev_M [address = "dev_M2" ]
  }
}
@enduml
```

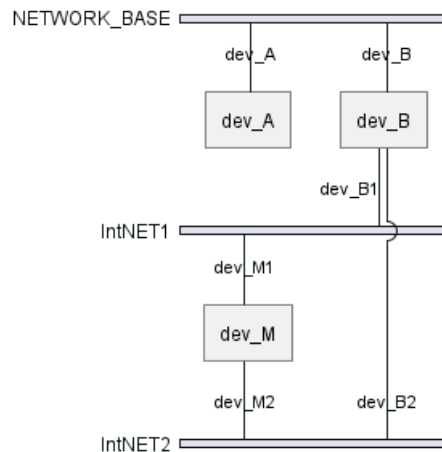

- only the first

```
@startuml
nwdiag {
  network NETWORK_BASE {
    width = full
    dev_A [address = "dev_A" ]
    dev_B [address = "dev_B" ]
  }
}
```



```

}
network IntNET1 {
  dev_B [address = "dev_B1" ]
  dev_M [address = "dev_M1" ]
}
network IntNET2 {
  dev_B [address = "dev_B2" ]
  dev_M [address = "dev_M2" ]
}
}
}
@enduml

```

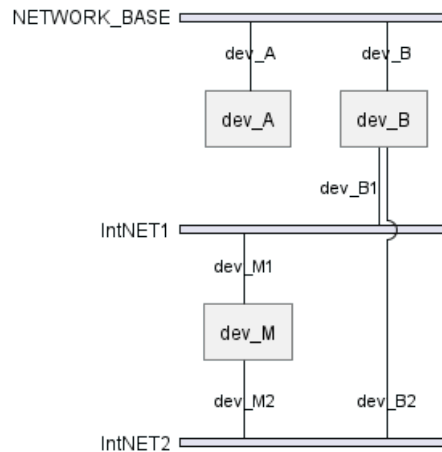

- the first and the second

```

@startuml
nwdiag {
  network NETWORK_BASE {
    width = full
    dev_A [address = "dev_A" ]
    dev_B [address = "dev_B" ]
  }
  network IntNET1 {
    width = full
    dev_B [address = "dev_B1" ]
    dev_M [address = "dev_M1" ]
  }
  network IntNET2 {
    dev_B [address = "dev_B2" ]
    dev_M [address = "dev_M2" ]
  }
}
}
@enduml

```



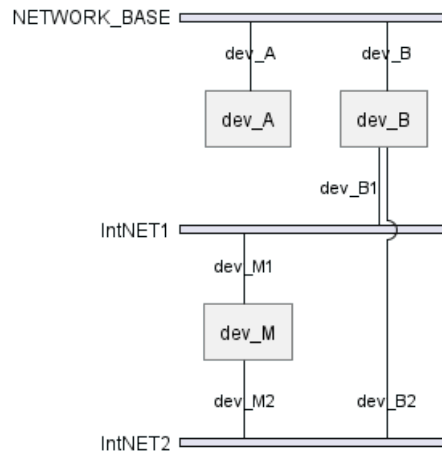

- all the network (with same full width)

```

@startuml
nwdiag {
  network NETWORK_BASE {
    width = full
    dev_A [address = "dev_A" ]
    dev_B [address = "dev_B" ]
  }
  network IntNET1 {
    width = full
    dev_B [address = "dev_B1" ]
    dev_M [address = "dev_M1" ]
  }
  network IntNET2 {
    width = full
    dev_B [address = "dev_B2" ]
    dev_M [address = "dev_M2" ]
  }
}
}
@enduml
  
```

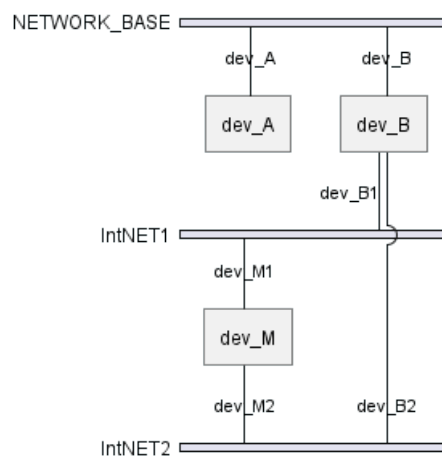

13.13 Other internal networks

You can define other internal networks (TCP/IP, USB, SERIAL,...).

- Without address or type

```
@startuml
nwdiag {
  network LAN1 {
    a [address = "a1"];
  }
  network LAN2 {
    a [address = "a2"];
    switch;
  }
  switch -- equip;
  equip -- printer;
}
@enduml
```

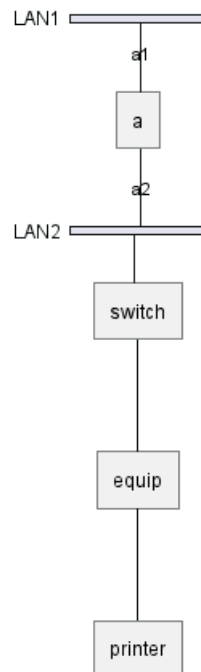

- With address or type

```
@startuml
nwdiag {
  network LAN1 {
    a [address = "a1"];
  }
  network LAN2 {
    a [address = "a2"];
    switch [address = "s2"];
  }
  switch -- equip;
  equip [address = "e3"];
  equip -- printer;
  printer [address = "USB"];
}
@enduml
```



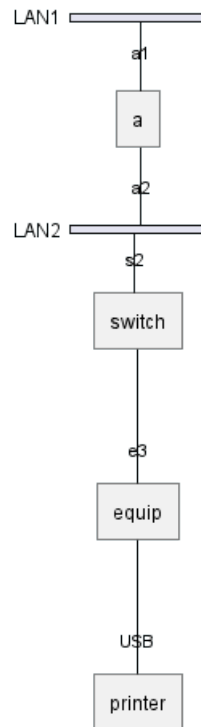

[Ref. QA-12824]

13.14 Using (global) style

13.14.1 Without style (by default)

```

@startuml
nwdiag {
  network DMZ {
    address = "y.x.x.x/24"
    web01 [address = "y.x.x.1"];
    web02 [address = "y.x.x.2"];
  }

  network Internal {
    web01;
    web02;
    db01 [address = "w.w.w.z", shape = database];
  }

  group {
    description = "long group label";
    web01;
    web02;
    db01;
  }
}
@enduml

```



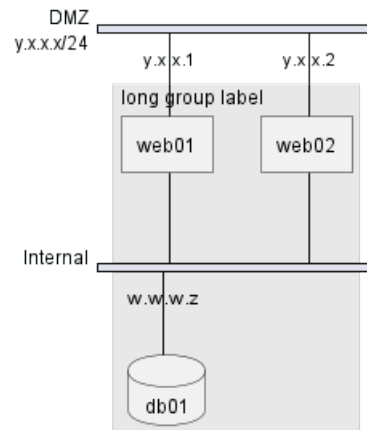

13.14.2 With style

You can use style to change rendering of elements.

```

@startuml
<style>
nwdiagDiagram {
  network {
    BackGroundColor green
    LineColor red
    LineThickness 1.0
    FontSize 18
    FontColor navy
  }
  server {
    BackGroundColor pink
    LineColor yellow
    LineThickness 1.0
    ' FontXXX only for description or label
    FontSize 18
    FontColor #blue
  }
  arrow {
    ' FontXXX only for address
    FontSize 17
    FontColor #red
    FontName Monospaced
    LineColor black
  }
  group {
    BackGroundColor cadetblue
    LineColor black
    LineThickness 2.0
    FontSize 11
    FontStyle bold
    Margin 5
    Padding 5
  }
}
</style>
nwdiag {

```



```

network DMZ {
    address = "y.x.x.x/24"
    web01 [address = "y.x.x.1"];
    web02 [address = "y.x.x.2"];
}

network Internal {
    web01;
    web02;
    db01 [address = "w.w.w.z", shape = database];
}

group {
    description = "long group label";
    web01;
    web02;
    db01;
}
}
@enduml

```

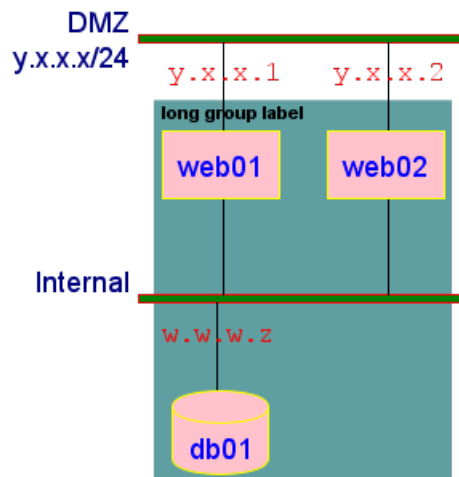

[Ref. QA-14479]

13.15 Appendix: Test of all shapes on Network diagram (nwdiag)

```

@startuml
nwdiag {
    network Network {
        Actor      [shape = actor]
        Agent      [shape = agent]
        Artifact   [shape = artifact]
        Boundary   [shape = boundary]
        Card       [shape = card]
        Cloud      [shape = cloud]
        Collections [shape = collections]
        Component  [shape = component]
    }
}
@enduml

```



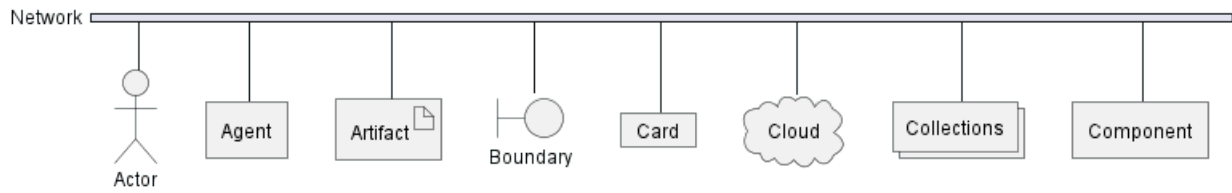

```

@startuml
nwdiag {
  network Network {
    Control      [shape = control]
    Database     [shape = database]
    Entity       [shape = entity]
    File        [shape = file]
    Folder      [shape = folder]
    Frame       [shape = frame]
    Hexagon     [shape = hexagon]
    Interface   [shape = interface]
  }
}
@enduml

```

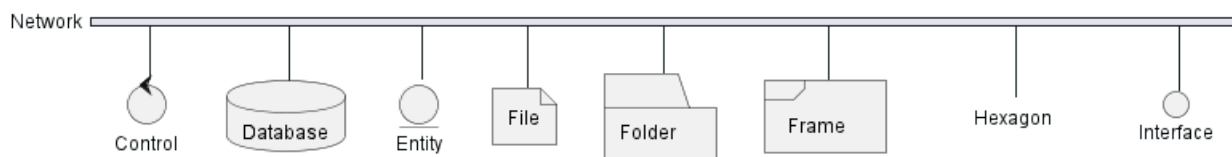

```

@startuml
nwdiag {
  network Network {
    Label       [shape = label]
    Node       [shape = node]
    Package    [shape = package]
    Person     [shape = person]
    Queue     [shape = queue]
    Stack     [shape = stack]
    Rectangle [shape = rectangle]
    Storage   [shape = storage]
    Usecase   [shape = usecase]
  }
}
@enduml

```

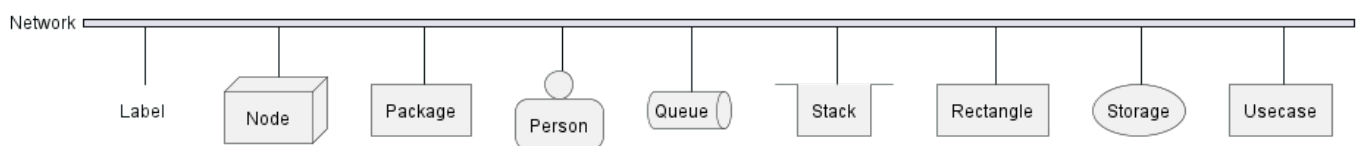

TODO: FIXME olli level 0 Overlap of label for folder olli olli level 0 Hexagon shape is missing olli olli

```

@startuml
nwdiag {
network Network {
Folder [shape = folder]
Hexagon [shape = hexagon]
}
}
@enduml

```

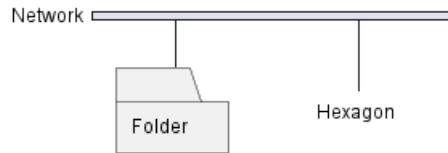

```

@startuml
nwdiag {
network Network {
Folder [shape = folder, description = "Test, long long label\nTest, long long label"]
Hexagon [shape = hexagon, description = "Test, long long label\nTest, long long label"]
}
}
@enduml

```

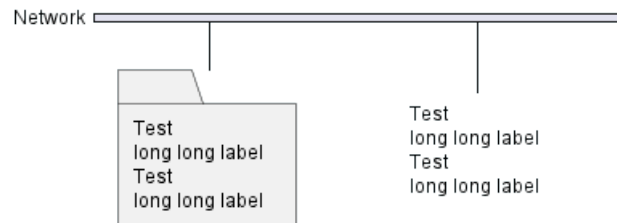

TODO: FIXME

14 Salt (Wireframe)

Salt est un sous projet inclus dans PlantUML qui peut vous aider à modeler une interface graphique ou une *maquette fonctionnelle* ou un *Wireframe* (en anglais).

Le but de cet outil est de pouvoir contruire, échanger et discuter facilement sur des échantillons de fenêtres simples.

Vous pouvez utiliser soit le mot clé `@startsalt`, ou bien `@startuml` suivi par une ligne avec le mot clé `salt`.

14.1 Composants de base

Une fenêtre doit commencer et finir par une accolade.

Vous pouvez ensuite définir :

- un bouton en utilisant [et],
- un bouton radio en utilisant (et),
- une case à cocher en utilisant [et],
- une zone de texte utilisateur en utilisant "
- une liste déroulante en utilisant ^.

```
@startsalt
{
  Just plain text
  [This is my button]
  () Unchecked radio
  (X) Checked radio
  [] Unchecked box
  [X] Checked box
  "Enter text here  "
  ^This is a droplist^
}
@endsalt
```

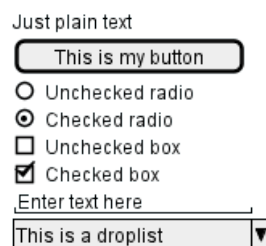

14.2 Text area

Here is an attempt to create a text area:

```
@startsalt
{+
  This is a long
  text in a textarea
  .
  "
}
@endsalt
```



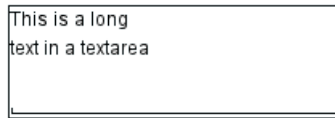

Note:

- the dot (.) to fill up vertical space;
- the last line of space (" ") to make the area wider.

[Ref. QA-14765]

Then you can add scroll bar:

```
@startsalt
{SI
  This is a long
  text in a textarea
  .
  " "
}
@endsalt
```



```
@startsalt
{S-
  This is a long
  text in a textarea
  .
  " "
}
@endsalt
```

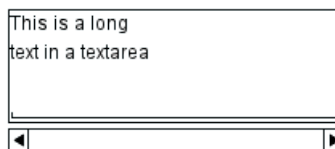

14.3 Ouvrir, fermer une liste déroulante

Vous pouvez ouvrir une liste déroulante, en ajoutant des valeurs entourées de ^, comme :

```
@startsalt
{
  ^This is a closed droplist^ |
  ^This is an open droplist^^ item 1^^ item 2^ |
  ^This is another open droplist^ item 1^ item 2^
}
@endsalt
```

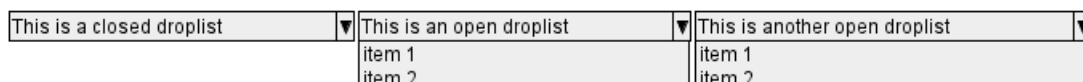

[Réf. QA-4184]



14.4 Utilisation de la grille [| et #, !, -, +]

Un tableau est automatiquement créé lorsque vous utilisez une parenthèse ouvrante {. Et vous devez utiliser | pour séparer les colonnes.

Par exemple

```
@startsalt
{
  Login    | "MyName  "
  Password | "****   "
  [Cancel] | [ OK   ]
}
@endsalt
```

Juste après le crochet ouvrant, vous pouvez utiliser un caractère pour définir si vous voulez dessiner des lignes ou des colonnes de la grille

Symbole	Résultat
#	Pour afficher toutes les lignes verticales et horizontales
!	Pour afficher toutes les lignes verticales
-	Pour afficher toutes les lignes horizontales
+	Pour afficher les lignes externes

```
@startsalt
{+
  Login    | "MyName  "
  Password | "****   "
  [Cancel] | [ OK   ]
}
@endsalt
```

14.5 Regroupement de champs

Plus d'information [ici](#)

```
@startsalt
{"My group box"
  Login    | "MyName  "
  Password | "****   "
  [Cancel] | [ OK   ]
}
@endsalt
```

14.6 Utilisation des séparateurs

Vous pouvez utiliser de nombreuses lignes horizontales en tant que séparateur.



```

@startsalt
{
  Text1
  ..
  "Some field"
  ==
  Note on usage
  ~~
  Another text
  --
  [Ok]
}
@endsalt

```

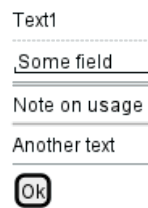

14.7 Arbre (structure arborescente) [T]

Pour faire un arbre ou une structure arborescente, vous devez commencer avec {T et utiliser + pour signaler la hiérarchie.

```

@startsalt
{
{T
  + World
  ++ America
  +++ Canada
  +++ USA
  ++++ New York
  ++++ Boston
  +++ Mexico
  ++ Europe
  +++ Italy
  +++ Germany
  ++++ Berlin
  ++ Africa
}
}
@endsalt

```



14.8 Arbre et Tableau [T]

Vous pouvez combiner des arbres avec des tableaux.



```

@startsalt
{
{T
+Region      | Population  | Age
+ World      | 7.13 billion | 30
++ America   | 964 million  | 30
+++ Canada   | 35 million   | 30
+++ USA      | 319 million  | 30
++++ NYC     | 8 million    | 30
++++ Boston  | 617 thousand | 30
+++ Mexico   | 117 million  | 30
++ Europe    | 601 million  | 30
+++ Italy    | 61 million   | 30
+++ Germany  | 82 million   | 30
++++ Berlin  | 3 million    | 30
++ Africa    | 1 billion    | 30
}
}
@endsalt

```

Region	Population	Age
World	7.13 billion	30
America	964 million	30
Canada	35 million	30
USA	319 million	30
NYC	8 million	30
Boston	617 thousand	30
Mexico	117 million	30
Europe	601 million	30
Italy	61 million	30
Germany	82 million	30
Berlin	3 million	30
Africa	1 billion	30

Et ajouter des lignes

```

@startsalt
{
..
== with T!
{T!
+Region      | Population  | Age
+ World      | 7.13 billion | 30
++ America   | 964 million  | 30
}
..
== with T-
{T-
+Region      | Population  | Age
+ World      | 7.13 billion | 30
++ America   | 964 million  | 30
}
..
== with T+
{T+
+Region      | Population  | Age
+ World      | 7.13 billion | 30
++ America   | 964 million  | 30
}
..
== with T#
{T#

```



```
+Region      | Population | Age
+ World      | 7.13 billion | 30
++ America   | 964 million | 30
}
..
}
@endsalt
```

with T!		
Region	Population	Age
World	7.13 billion	30
America	964 million	30

with T-		
Region	Population	Age
World	7.13 billion	30
America	964 million	30

with T+		
Region	Population	Age
World	7.13 billion	30
America	964 million	30

with T#		
Region	Population	Age
World	7.13 billion	30
America	964 million	30

[Réf. QA-1265]

14.9 Accolades délimitantes [{, }]

Vous pouvez définir des sous-éléments en créant une accolade ouvrante.

```
@startsalt
{
Name      | "          "
Modifiers: | { (X) public | () default | () private | () protected
           | [] abstract | [] final   | [] static }
Superclass: | { "java.lang.Object " | [Browse...] }
}
@endsalt
```

Name: _____

Modifiers: public default private protected
 abstract final static

Superclass: java.lang.Object

14.10 Ajout d'onglet [/]

Vous pouvez ajouter des onglets avec la notation {/}. Notez que vous pouvez utiliser du code HTML pour avoir un texte en gras.

```
@startsalt
{+
{/ <b>General | Fullscreen | Behavior | Saving }
{
{ Open image in: | ^Smart Mode^ }
[X] Smooth images when zoomed
[X] Confirm image deletion
[ ] Show hidden images
}
[Close]
}
```



```
@endsalt
```

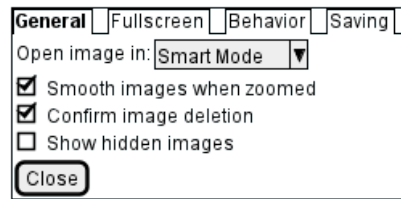

Les onglets peuvent également être orientés verticalement:

```
@startsalt
{+
{/ <b>General
Fullscreen
Behavior
Saving } |
{
{ Open image in: | ^Smart Mode^ }
[X] Smooth images when zoomed
[X] Confirm image deletion
[ ] Show hidden images
[Close]
}
}
@endsalt
```



14.11 Utilisation de menu [*]

Vous pouvez ajouter un menu en utilisant la notation {*

```
@startsalt
{+
{* File | Edit | Source | Refactor }
{/ General | Fullscreen | Behavior | Saving }
{
{ Open image in: | ^Smart Mode^ }
[X] Smooth images when zoomed
[X] Confirm image deletion
[ ] Show hidden images
}
[Close]
}
@endsalt
```

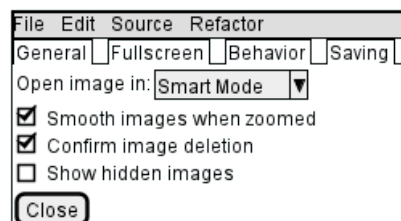

Il est également possible d'ouvrir un menu

```
@startsalt
{+
{* File | Edit | Source | Refactor
  Refactor | New | Open File | - | Close | Close All }
{/ General | Fullscreen | Behavior | Saving }
{
{ Open image in: | ^Smart Mode^ }
[X] Smooth images when zoomed
[X] Confirm image deletion
[ ] Show hidden images
}
[Close]
}
@endsalt
```

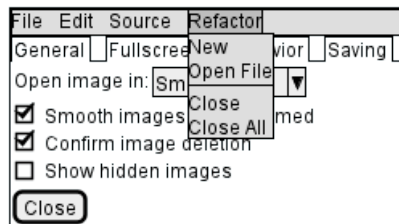

Comme il est possible d'ouvrir une liste déroulante

```
@startsalt
{+
{* File | Edit | Source | Refactor }
{/ General | Fullscreen | Behavior | Saving }
{
{ Open image in: | ^Smart Mode^^Normal Mode^ }
[X] Smooth images when zoomed
[X] Confirm image deletion
[ ] Show hidden images
}
[Close]
}
@endsalt
```

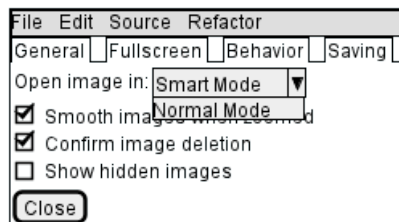

[Réf. QA-4184]

14.12 Tableaux avancés

Vous pouvez utiliser deux notations spéciales pour les tableaux :

- * pour indiquer que la cellule de gauche peut s'étendre sur l'actuelle
- . pour indiquer une cellule vide

```
@startsalt
{#
. | Column 2 | Column 3
```



```

Row header 1 | value 1 | value 2
Row header 2 | A long cell | *
}
@endsalt

```

	Column 2	Column 3
Row header 1	value 1	value 2
Row header 2	A long cell	

14.13 Barres de défilement [S, SI, S-]

Vous pouvez utiliser la commande {S pour afficher les barres de défilement comme dans les exemples suivants :

- {S : barres de défilement verticale et horizontale

```

@startsalt
{S
Message
.
.
.
.
}
@endsalt

```



- {SI : barre de défilement verticale seulement

```

@startsalt
{SI
Message
.
.
.
.
}
@endsalt

```



- {S- : barre de défilement horizontale seulement

```

@startsalt
{S-
Message
.
.
.
.
}
@endsalt

```





14.14 Couleurs

Il est possible de modifier la couleur du texte du widget

```
@startsalt
{
  <color:Blue>Just plain text
  [This is my default button]
  [<color:green>This is my green button]
  [<color:#9a9a9a>This is my disabled button]
  [] <color:red>Unchecked box
  [X] <color:green>Checked box
  "Enter text here  "
  ^This is a droplist^
  ^<color:#9a9a9a>This is a disabled droplist^
  ^<color:red>This is a red droplist^
}
@endsalt
```



[Ref. QA-12177]

14.15 Creole on Salt

You can use Creole or HTML Creole on salt:

```
@startsalt
{|^==Creole
  This is bold
  This is italics
  This is "monospaced"
  This is stricken-out
  This is underlined
  This is wave-underlined
  --test Unicode and icons--
  This is <U+221E> long
  This is a <&code> icon
  Use image : <img:http://plantuml.com/logo3.png>
}|
{|^<b>HTML Creole
  This is <b>bold</b>
  This is <i>italics</i>
  This is <font:monospaced>monospaced</font>
```



```

This is <s>stroked</s>
This is <u>underlined</u>
This is <w>waved</w>
This is <s:green>stroked</s>
This is <u:red>underlined</u>
This is <w:#0000FF>waved</w>
-- other examples --
This is <color:blue>Blue</color>
This is <back:orange>Orange background</back>
This is <size:20>big</size>
}|
{^Creole line
You can have horizontal line
----
Or double line
====
Or strong line
----
Or dotted line
..My title..
Or dotted title
//and title... //
==Title==
Or double-line title
--Another title--
Or single-line title
Enjoy!
}|
{^Creole list item
**test list 1**
* Bullet list
* Second item
** Sub item
*** Sub sub item
* Third item
----
**test list 2**
# Numbered list
# Second item
## Sub item
## Another sub item
# Third item
}|
{^Mix on salt
  ==<color:Blue>Just plain text
  [This is my default button]
  [<b><color:green>This is my green button]
  [ ---<color:#9a9a9a>This is my disabled button-- ]
  [] <size:20><color:red>Unchecked box
  [X] <color:green>Checked box
  "//Enter text here//  "
  ^This is a droplist^
  ^<color:#9a9a9a>This is a disabled droplist^
  ^<b><color:red>This is a red droplist^
}}
@endsalt

```



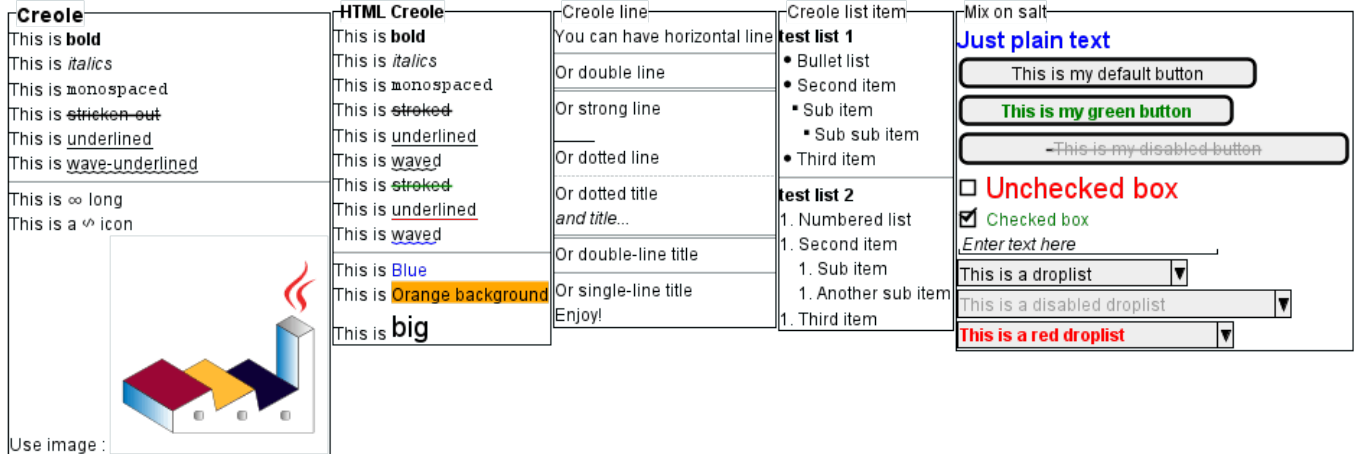

14.16 Pseudo sprite [«, »]

En utilisant << et >>, vous pouvez définir un dessin de type pseudo-sprite ou sprite et le réutiliser ultérieurement

```
@startsalt
{
[X] checkbox|[ ] checkbox
() radio | (X) radio
This is a text|[This is my button]|This is another text
"A field"|"Another long Field"|[A button]
<<folder
.....
.XXXXXX.....
.X...X.....
.XXXXXXXXXX.
.X.....X.
.X.....X.
.X.....X.
.X.....X.
.X.....X.
.XXXXXXXX.
.....
>>|<color:blue>other folder|<<folder>>
^Droplist^
}
@endsalt
```

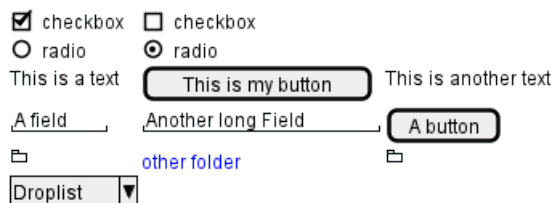

[Réf. QA-5849]

14.17 OpenIconic

OpenIconic is an very nice open source icon set. Those icons have been integrated into the creole parser, so you can use them out-of-the-box.

You can use the following syntax: <&ICON_NAME>.

```
@startsalt
```

```

{
  Login<&person> | "MyName  "
  Password<&key> | "****  "
  [Cancel <&circle-x>] | [OK <&account-login>]
}
@endsalt

```



The complete list is available on OpenIconic Website, or you can use the following special diagram:

```

@startuml
listopeniconic
@enduml

```

List Open Iconic	▲ bell	☁ cloud	≡ excerpt	≡ justify-right	🎵 musical-note	★ star
<i>Credit to</i> https://useiconic.com/open	📶 bluetooth	☁️ cloudy	⌵ expand-down	🔑 key	📎 paperclip	☀ sun
	🔤 bold	📄 code	⌵ expand-left	💻 laptop	✍ pencil	📱 tablet
➡ account-login	⚙ bolt	🧠 cog	⌵ expand-right	📂 layers	👤 person	🏷 tag
➡ account-logout	📖 book	⌵ collapse-down	⌵ expand-up	💡 lightbulb	👤 person	🏷 tags
↶ action-redo	🔖 bookmark	⌵ collapse-left	🔗 external-link	🔗 link-broken	📱 phone	🎯 target
↷ action-undo	📦 box	⌵ collapse-right	👁 eye	🔗 link-intact	📊 pie-chart	📋 task
≡ align-center	📁 briefcase	⌵ collapse-up	👁 eyedropper	📋 list-rich	📌 pin	🖨 terminal
≡ align-left	£ british-pound	⌵ collapse-up	📁 file	📋 list	🎮 play-circle	📄 text
≡ align-right	🗂 browser	⌵ collapse-up	🔥 fire	📍 location	➕ plus	⬇ thumb-down
🔍 aperture	🖌 brush	⌵ collapse-up	🚩 flag	🔒 lock-locked	🔌 power-standby	👍 thumb-up
↓ arrow-bottom	🐛 bug	⌵ collapse-up	⚡ flash	🔒 lock-unlocked	🖨 print	⌚ timer
🕒 arrow-circle-bottom	📣 bullhorn	≡ copywriting	📁 folder	🔓 loop-circular	📁 project	🗑 trash
🕒 arrow-circle-left	📊 calculator	≡ credit-card	🔗 fork	🔓 loop-square	📌 pulse	📄 underline
🕒 arrow-circle-right	📅 calendar	🗂 crop	🖥 fullscreen-enter	🔓 loop	🧩 puzzle-piece	📄 vertical-align-bottom
🕒 arrow-circle-top	📷 camera-slr	📊 dashboard	🖥 fullscreen-exit	🔍 magnifying-glass	? question-mark	📄 vertical-align-center
↶ arrow-left	⏪ caret-bottom	⬇ data-transfer-download	🌐 globe	📍 map-marker	☔ rain	📄 vertical-align-top
↷ arrow-right	↶ caret-left	⬆ data-transfer-upload	📊 graph	🗺 map	🎲 random	📄 video
⬇ arrow-thick-bottom	↷ caret-right	🗑 delete	📊 grid-four-up	⏸ media-pause	🔄 reload	📄 volume-high
↶ arrow-thick-left	⬆ caret-top	📞 dial	📊 grid-three-up	▶ media-play	↕ resize-both	📄 volume-low
↷ arrow-thick-right	🗂 cart	📄 document	📊 grid-two-up	🎵 media-record	↕ resize-height	📄 volume-off
⬆ arrow-thick-top	🗨 chat	💰 dollar	💾 hard-drive	⏮ media-skip-backward	↔ resize-width	⚠ warning
⬆ arrow-top	✓ check	” double-quote-sans-left	📄 header	▶ media-skip-forward	📡 rss-alt	📶 wifi
📊 audio-spectrum	↶ chevron-bottom	“ double-quote-sans-right	🎧 headphones	⏪ media-step-backward	📡 rss	🔧 wrench
🔊 audio	↶ chevron-left	” double-quote-serif-left	♥ heart	⏪ media-step-forward	📄 script	✖ x
🏷 badge	↷ chevron-right	” double-quote-serif-right	🏠 home	⏸ media-stop	📄 share-boxed	👤 yen
🚫 ban	⬆ chevron-top	💧 droplet	🖼 image	🏥 medical-cross	➡ share	🛡 shield
📊 bar-chart	🕒 circle-check	🏗 eject	📧 inbox	☰ menu	🛡 shield	🔍 zoom-in
🔋 battery-empty	🕒 circle-x	🏠 elevator	∞ infinity	🎤 microphone	📶 signal	🔍 zoom-out
🔋 battery-full	📄 clipboard	⋯ ellipses	📄 info	➖ minus	📍 signpost	
🧴 beaker	🕒 clock	✉ envelope-closed	📄 italic	📄 monitor	↕ sort-ascending	
	☁ cloud-download	✉ envelope-open	≡ justify-center	🌙 moon	↕ sort-descending	
	☁ cloud-upload	€ euro	≡ justify-left	➕ move	📄 spreadsheet	

14.18 Ajouter un titre, un en-tête, un pied de page, une légende

```

@startsalt
title My title
header some header
footer some footer
caption This is caption
legend
The legend
end legend

```

```

{+
  Login | "MyName  "
  Password | "****  "
  [Cancel] | [ OK ]
}

```



```
@endsalt
```



(Voir aussi : *Commandes communes*)

14.19 Zoom, DPI

14.19.1 Sans zoom (par défaut)

```
@startsalt
{
  <&person> Login | "MyName  "
  <&key> Password | "****    "
  [<&circle-x> Cancel ] | [ <&account-login> OK   ]
}
@endsalt
```

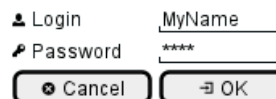

14.19.2 Scale

Vous pouvez utiliser la commande `scale` pour zoomer l'image générée.

Vous pouvez utiliser un nombre ou une fraction pour définir le facteur d'échelle. Vous pouvez également indiquer soit la largeur, soit la hauteur (en pixels). Et vous pouvez également donner à la fois la largeur et la hauteur : l'image est mise à l'échelle pour s'adapter à la dimension spécifiée

```
@startsalt
scale 2
{
  <&person> Login | "MyName  "
  <&key> Password | "****    "
  [<&circle-x> Cancel ] | [ <&account-login> OK   ]
}
@endsalt
```

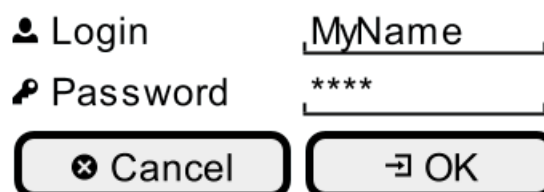

(Voir aussi : *[Zoom sur les commandes communes](commons#zw5yrgax40mpk362kjbh)*)

14.19.3 DPI

Vous pouvez également utiliser la commande `skinparam dpi` pour zoomer l'image générée



```

@startsalt
skinparam dpi 200
{
  <&person> Login | "MyName  "
  <&key> Password | "****  "
  [<&circle-x> Cancel ] | [ <&account-login> OK  ]
}
@endsalt

```

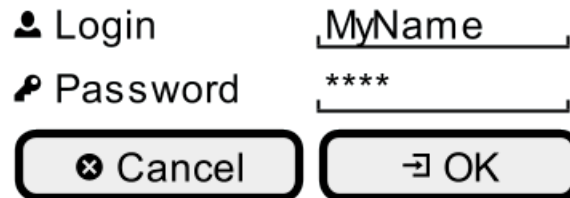

14.20 Include Salt "on activity diagram"

You can read the following explanation.

```

@startuml
(*) --> "
{{
salt
{+
<b>an example
choose one option
()one
()two
[ok]
}
}}
" as choose

choose -right-> "
{{
salt
{+
<b>please wait
operation in progress
<&clock>
[cancel]
}
}}
" as wait
wait -right-> "
{{
salt
{+
<b>success
congratulations!
[ok]
}
}}
" as success

wait -down-> "
{{

```



```

salt
{+
<b>error
failed, sorry
[ok]
}
}}
"
@enduml

```

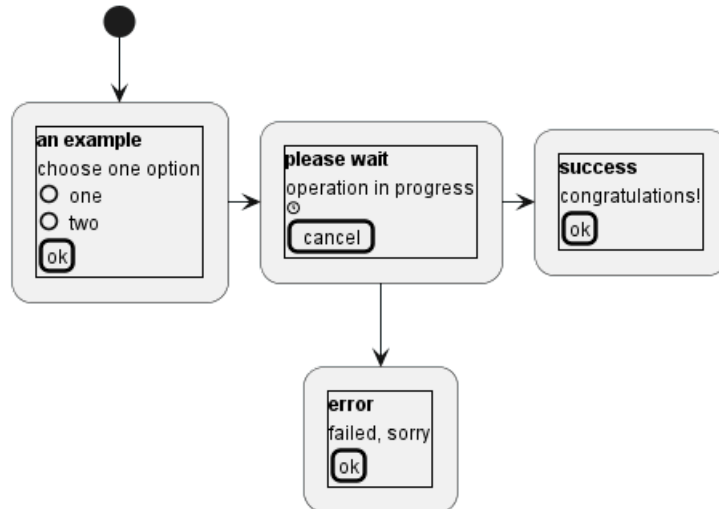

It can also be combined with define macro.

```

@startuml
!unquoted procedure SALT($x)
"{{
salt
%invoke_procedure("_"+"$x)
}}" as $x
!endprocedure

!procedure _choose()
{+
<b>an example
choose one option
()one
()two
[ok]
}
!endprocedure

!procedure _wait()
{+
<b>please wait
operation in progress
<&clock>
[cancel]
}
!endprocedure

!procedure _success()
{+
<b>success

```





```

congratulations!
[ok]
}
!endprocedure

!procedure _error()
{+
<b>error
failed, sorry
[ok]
}
!endprocedure

(*) --> SALT(choose)
-right-> SALT(wait)
wait -right-> SALT(success)
wait -down-> SALT(error)
@enduml

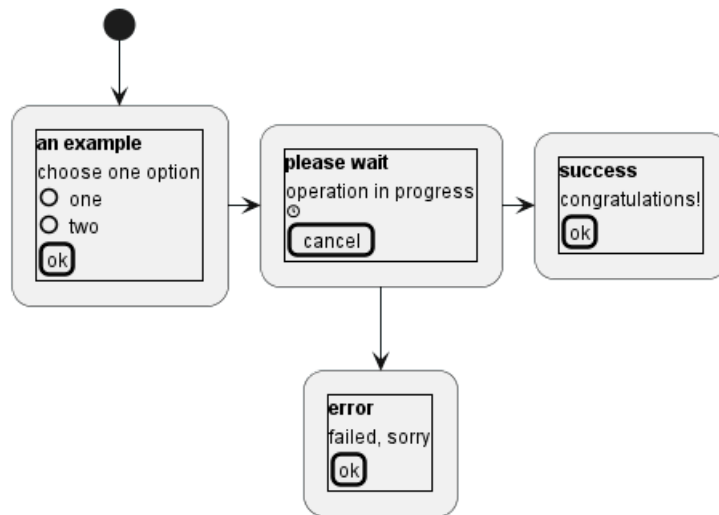
```



14.21 Include salt "on while condition of activity diagram"

You can include salt on while condition of activity diagram.

```

@startuml
start
while (\n{\nsalt\n{+\nPassword | "****      "\n[Cancel] | [ OK  ]}\n}}\n) is (Incorrect)
  :log attempt;
  :attempt_count++;
  if (attempt_count > 4) then (yes)
    :increase delay timer;
    :wait for timer to expire;
  else (no)
  endif
endwhile (correct)
:log request;
:disable service;
@enduml

```

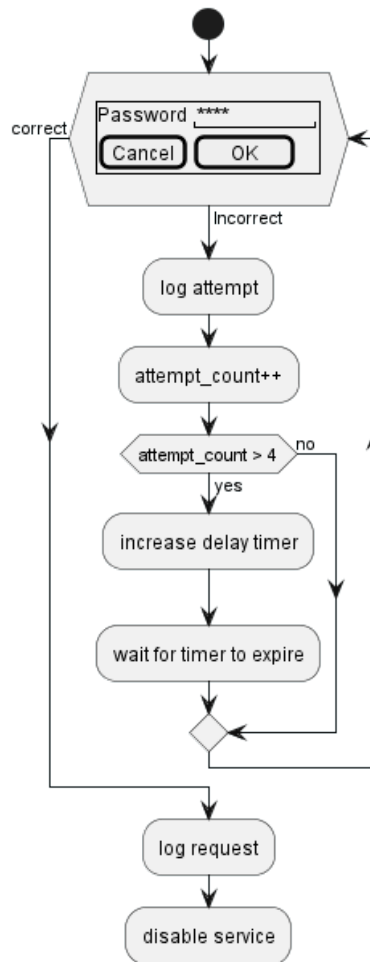

[Ref. QA-8547]

14.22 Include salt "on repeat while condition of activity diagram"

You can include salt on 'repeat while' condition of activity diagram.

```

@startuml
start
repeat :read data;
  :generate diagrams;
repeat while (\n{\nsalt\n{"Next step"\n Do you want to continue? \n[Yes] | [No]\n}\n})\n
stop
@enduml
  
```

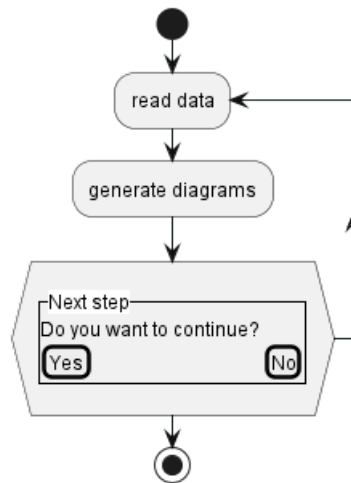

[Ref. QA-14287]

14.23 Skinparam

You can use [only] some skinparam command to change the skin of the drawing.

Some example:

```

@startsalt
skinparam Backgroundcolor palegreen
{+
  Login    | "MyName  "
  Password | "****    "
  [Cancel] | [ OK   ]
}
@endsalt
  
```

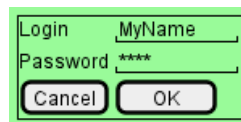

```

@startsalt
skinparam handwritten true
{+
  Login    | "MyName  "
  Password | "****    "
  [Cancel] | [ OK   ]
}
@endsalt
  
```



TODO: FIXME FYI, some other skinparam does not work with salt, as:

```

@startsalt
skinparam defaultFontName monospaced
{+
  Login    | "MyName  "
  Password | "****    "
  [Cancel] | [ OK   ]
}
@endsalt
  
```



14.24 Style

You can use [only] some style command to change the skin of the drawing.

Some example:

```
@startsalt
<style>
saltDiagram {
  BackgroundColor palegreen
}
</style>
{+
  Login | "MyName  "
  Password | "****  "
  [Cancel] | [ OK  ]
}
@endsalt
```

TODO: FIXME FYI, some other style does not work with salt, as:

```
@startsalt
<style>
saltDiagram {
  Fontname Monospaced
  FontSize 10
  FontStyle italic
  LineThickness 0.5
  LineColor red
}
</style>
{+
  Login | "MyName  "
  Password | "****  "
  [Cancel] | [ OK  ]
}
@endsalt
```

[Ref. QA-13460]



15 Diagramme Archimate

Ceci n'est qu'une proposition qui est susceptible d'évoluer.

Vous êtes invités à créer des discussions sur cette future syntaxe. Vos retours, vos idées et vos suggestions nous aideront à trouver la meilleure solution.

15.1 Mot-clé Archimate

Vous pouvez utiliser le mot-clé `archimate` pour définir un élément. De façon optionnelle, un stéréotype peut indiquer une icône à afficher. Certains noms de couleurs (`Business`, `Application`, `Motivation`, `Strategy`, `Technology`, `Physical`, `Implementation`) sont aussi disponibles.

```
@startuml
archimate #Technology "Serveur VPN" as vpnServerA <<technology-device>>

rectangle GO #lightgreen
rectangle STOP #red
rectangle WAIT #orange
@enduml
```

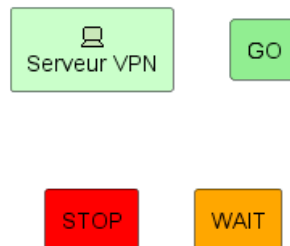

15.2 Jonctions Archimate

A l'aide du mot-clé `circle` et du préprocesseur, vous pouvez déclarer des jonctions.

```
@startuml
!define Junction_Or circle #black
!define Junction_And circle #whitesmoke

Junction_And JunctionAnd
Junction_Or JunctionOr

archimate #Technology "VPN Server" as vpnServerA <<technology-device>>

rectangle GO #lightgreen
rectangle STOP #red
rectangle WAIT #orange
GO -up-> JunctionOr
STOP -up-> JunctionOr
STOP -down-> JunctionAnd
WAIT -down-> JunctionAnd
@enduml
```

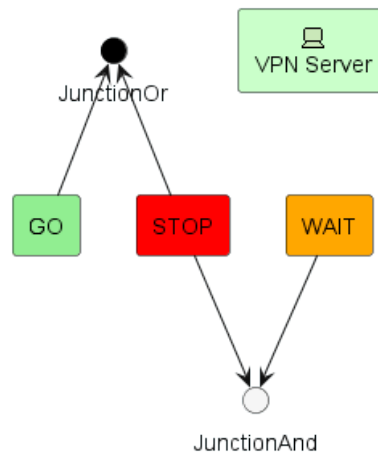

15.3 Exemple 1

```

@startuml
skinparam rectangle<<behavior>> {
  roundCorner 25
}
sprite $bProcess jar:archimate/business-process
sprite $aService jar:archimate/application-service
sprite $aComponent jar:archimate/application-component

rectangle "Handle claim" as HC <<$bProcess>><<behavior>> #Business
rectangle "Capture Information" as CI <<$bProcess>><<behavior>> #Business
rectangle "Notify\nAdditional Stakeholders" as NAS <<$bProcess>><<behavior>> #Business
rectangle "Validate" as V <<$bProcess>><<behavior>> #Business
rectangle "Investigate" as I <<$bProcess>><<behavior>> #Business
rectangle "Pay" as P <<$bProcess>><<behavior>> #Business

HC *-down- CI
HC *-down- NAS
HC *-down- V
HC *-down- I
HC *-down- P

CI -right->> NAS
NAS -right->> V
V -right->> I
I -right->> P

rectangle "Scanning" as scanning <<$aService>><<behavior>> #Application
rectangle "Customer administration" as customerAdministration <<$aService>><<behavior>> #Application
rectangle "Claims administration" as claimsAdministration <<$aService>><<behavior>> #Application
rectangle Printing <<$aService>><<behavior>> #Application
rectangle Payment <<$aService>><<behavior>> #Application

scanning -up-> CI
customerAdministration -up-> CI
claimsAdministration -up-> NAS
claimsAdministration -up-> V
claimsAdministration -up-> I
Payment -up-> P

Printing -up-> V
Printing -up-> P
  
```



```

rectangle "Document\nManagement\nSystem" as DMS <<$aComponent>> #Application
rectangle "General\nCRM\nSystem" as CRM <<$aComponent>> #Application
rectangle "Home & Away\nPolicy\nAdministration" as HAPA <<$aComponent>> #Application
rectangle "Home & Away\nFinancial\nAdministration" as HFPA <<$aComponent>> #Application
    
```

```

DMS .up.|> scanning
DMS .up.|> Printing
CRM .up.|> customerAdministration
HAPA .up.|> claimsAdministration
HFPA .up.|> Payment
    
```

```

legend left
Example from the "Archinsurance case study" (OpenGroup).
See
====
<$bProcess> :business process
====
<$aService> : application service
====
<$aComponent> : application component
endlegend
@enduml
    
```

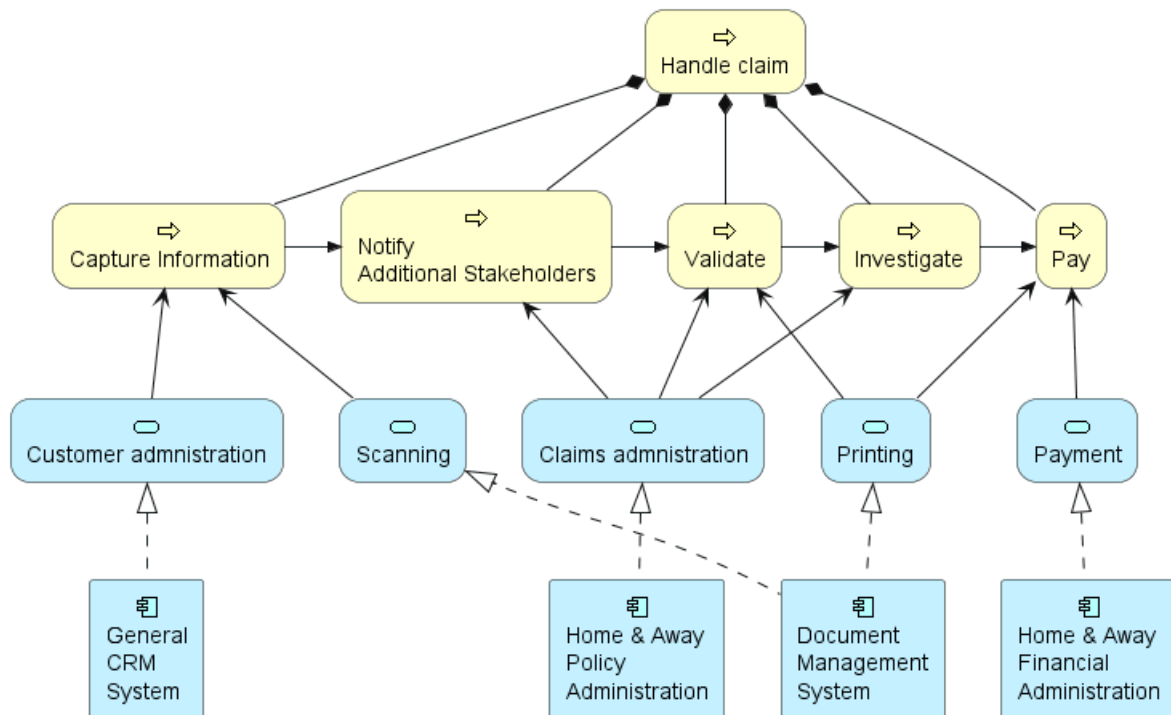

Example from the "Archinsurance case study" (OpenGroup). See
⇒ :business process
○ : application service
☐ : application component

15.4 Exemple 2

```
@startuml
```

```
skinparam roundcorner 25
rectangle "Capture Information" as CI <<$archimate/business-process>> #Business
@enduml
```

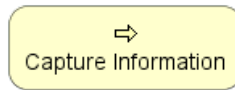

15.5 Liste des sprites possibles

Vous pouvez afficher tous les sprites disponibles pour Archimate à l'aide du diagramme suivant:

```
@startuml
listsprite
@enduml
```

List Current Sprites

Credit to
<http://www.archimatetool.com>

archimate :

access
activity
actor
aggregation
application-collaboration
application-component
application-data-object
application-event
application-function
application-interaction
application-interface
application-process
application-service
assessment-filled
assessment
assignment
association-unidirect
association
business-activity
business-actor
business-collaboration
business-contract
business-event
business-function
business-interaction
business-interface
business-location
business-meaning

business-object
business-process
business-product
business-representation
business-role
business-service
business-value
collaboration
communication-path
component
composition
constraint-filled
constraint
contract
deliverable-filled
deliverable
device
driver-filled
driver
event
flow
function
gap-filled
gap
goal-filled
goal
implementation-deliverable
implementation-event
implementation-gap
implementation-plateau
implementation-workpackage
influence
interaction
interface-required

interface-symmetric
interface
junction-and
junction-or
junction
location
meaning
motivation-assessment
motivation-constraint
motivation-driver
motivation-goal
motivation-meaning
motivation-outcome
motivation-principle
motivation-requirement
motivation-stakeholder
motivation-value
network
node
object
physical-distribution-network
physical-equipment
physical-facility
physical-material
plateau
principle-filled
principle
process
product
realisation
representation
requirement-filled
requirement
role

service
serving
specialisation
specialization
stakeholder-filled
strategy-capability
strategy-course-of-action
strategy-resource
strategy-value-stream
system-software
technology-artifact
technology-collaboration
technology-communication-network
technology-communication-path
technology-device
technology-event
technology-function
technology-infra-interface
technology-infra-service
technology-interaction
technology-interface
technology-network
technology-node
technology-path
technology-process
technology-service
technology-system-software
triggering
used-by
value
workpackage-filled

15.6 ArchiMate Macros

15.6.1 Archimate Macros and Library

A list of Archimate macros are defined Archimate-PlantUML here which simplifies the creation of ArchiMate diagrams, and Archimate is natively on the Standard Library of PlantUML.

15.6.2 Archimate elements

Using the macros, creation of ArchiMate elements are done using the following format: `Category_ElementName (nameOfThe "description")`

For example:

- To define a *Stakeholder* element, which is part of Motivation category, the syntax will be `Motivation_Stakeholder (S "Stakeholder Description")`:





```
@startuml
!include <archimate/Archimate>
Motivation_Stakeholder(StakeholderElement, "Stakeholder Description")
@enduml
```

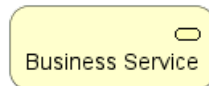

- To define a *Business Service* element, `Business_Service(BService, "Business Service")`:

```
@startuml
!include <archimate/Archimate>
Business_Service(BService, "Business Service")
@enduml
```



15.6.3 Archimate relationships

The ArchiMate relationships are defined with the following pattern: `Rel_RelationType(fromElement, toElement, "description")` and to define the direction/orientation of the two elements: `Rel_RelationType_Direction toElement, "description")`

The `RelationTypes` supported are:

- Access
- Aggregation
- Assignment
- Association
- Composition
- Flow
- Influence
- Realization
- Serving
- Specialization
- Triggering

The `Directions` supported are:

- Up
- Down
- Left
- Right

For example:

- To denote a composition relationship between the *Stakeholder* and *Business Service* defined above, the syntax will be

```
Rel_Composition(StakeholderElement, BService, "Description for the relationship")
```

```
@startuml
!include <archimate/Archimate>
Motivation_Stakeholder(StakeholderElement, "Stakeholder Description")
```



```

Business_Service(BService, "Business Service")
Rel_Composition(StakeholderElement, BService, "Description for the relationship")
@enduml

```

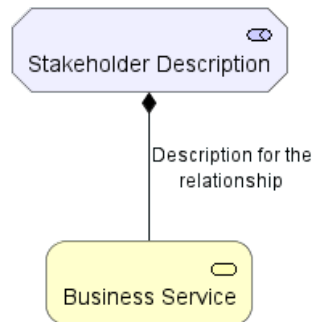

- Unordered List ItemTo orient the two elements in top - down position, the syntax will be

```

Rel_Composition_Down(StakeholderElement, BService, "Description for the relationship")
@startuml
!include <archimate/Archimate>
Motivation_Stakeholder(StakeholderElement, "Stakeholder Description")
Business_Service(BService, "Business Service")
Rel_Composition_Down(StakeholderElement, BService, "Description for the relationship")
@enduml

```

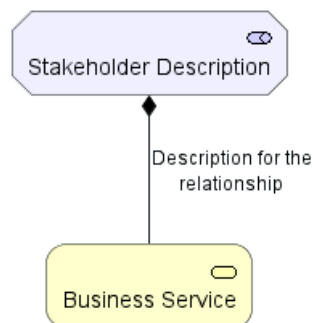

15.6.4 Appendice: Examples of all Archimate RelationTypes

```

@startuml
left to right direction
skinparam nodesep 4
!include <archimate/Archimate>
Rel_Triggering(i15, j15, Triggering)
Rel_Specialization(i14, j14, Specialization)
Rel_Serving(i13, j13, Serving)
Rel_Realization(i12, j12, Realization)
Rel_Influence(i11, j11, Influence)
Rel_Flow(i10, j10, Flow)
Rel_Composition(i9, j9, Composition)
Rel_Association_dir(i8, j8, Association_dir)
Rel_Association(i7, j7, Association)
Rel_Assignment(i6, j6, Assignment)
Rel_Aggregation(i5, j5, Aggregation)
Rel_Access_w(i4, j4, Access_w)
Rel_Access_rw(i3, j3, Access_rw)
Rel_Access_r(i2, j2, Access_r)
Rel_Access(i1, j1, Access)
@enduml

```



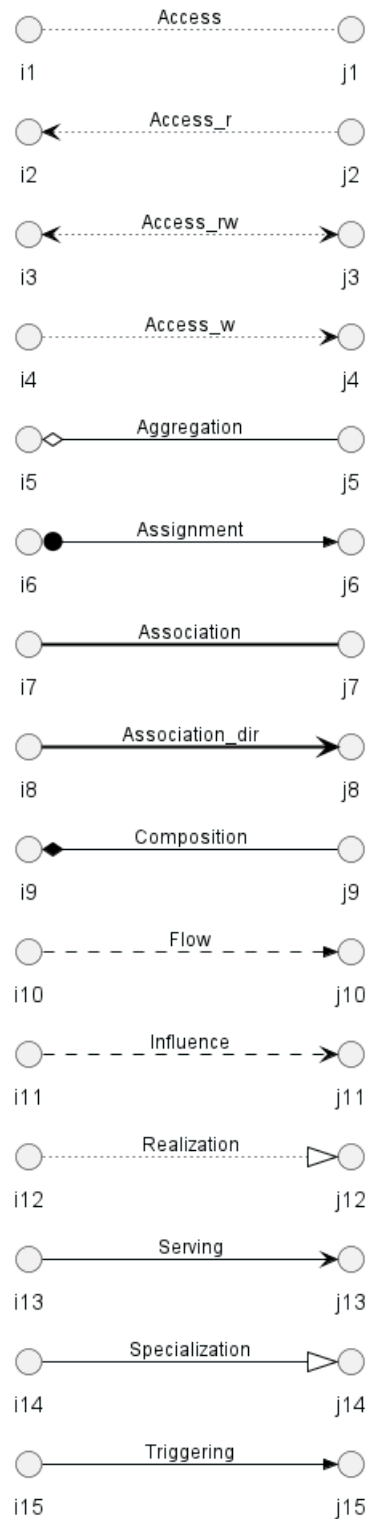

```

@startuml
title ArchiMate Relationships Overview
skinparam nodesep 5
<style>
interface {
    shadowing 0
    backgroundcolor transparent
    linecolor transparent
    FontColor transparent

```



```

}
</style>
!include <archimate/ArchiMate>
left to right direction

rectangle Other {
() i14
() j14
}

rectangle Dynamic {
() i10
() j10
() i15
() j15
}

rectangle Dependency {
() i13
() j13
() i4
() j4
() i11
() j11
() i7
() j7
}

rectangle Structural {
() i9
() j9
() i5
() j5
() i6
() j6
() i12
() j12
}

Rel_Triggering(i15, j15, Triggering)
Rel_Specialization(i14, j14, Specialization)
Rel_Serving(i13, j13, Serving)
Rel_Realization(i12, j12, Realization)
Rel_Influence(i11, j11, Influence)
Rel_Flow(i10, j10, Flow)
Rel_Composition(i9, j9, Composition)
Rel_Association_dir(i7, j7, \nAssociation_dir)
Rel_Association(i7, j7, Association)
Rel_Assignment(i6, j6, Assignment)
Rel_Aggregation(i5, j5, Aggregation)
Rel_Access_w(i4, j4, Access_w)
Rel_Access_rw(i4, j4, Access_rw)
Rel_Access_r(i4, j4, Access_r)
Rel_Access(i4, j4, Access)
@enduml

```

ArchiMate Relationships Overview

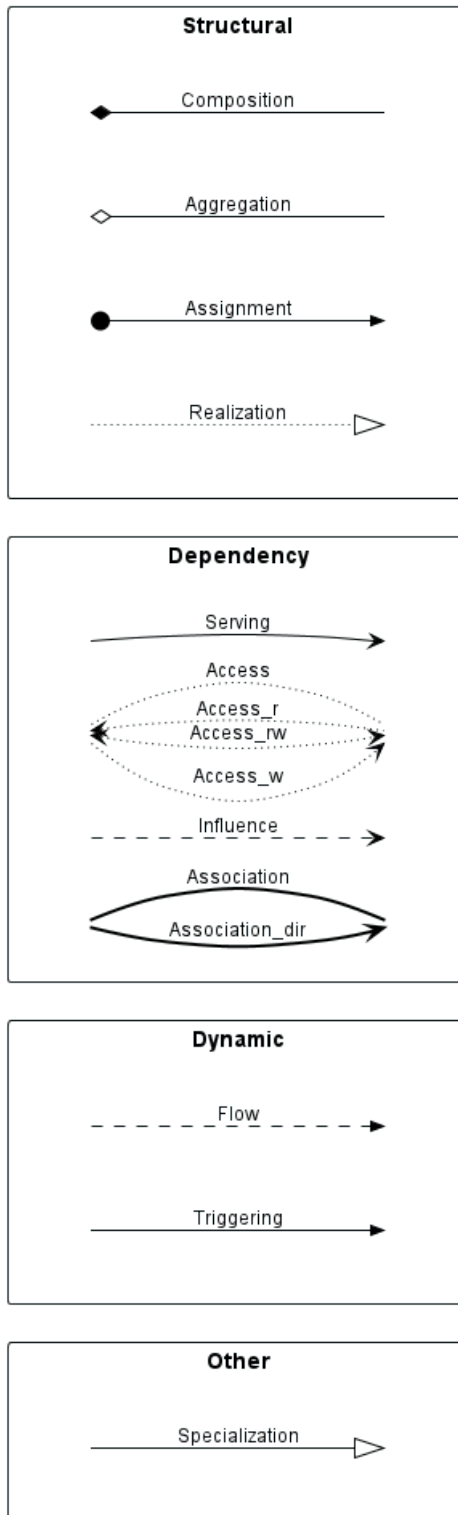

[Adapted from Archimate PR#25]

16 Diagramme de Gantt

Le Gantt doit être décrit en anglais, à l'aide de phrase très simple (sujet-verbe-complément).

16.1 Déclaration des tâches

Tâches définies à l'aide de crochets.

16.1.1 Durée

Leurs durées sont définies à l'aide du verbe `lasts`

```
@startgantt
[Prototype design] lasts 15 days
[Test prototype] lasts 10 days
-- All example --
[Task 1 (1 day)] lasts 1 day
[T2 (5 days)] lasts 5 days
[T3 (1 week)] lasts 1 week
[T4 (1 week and 4 days)] lasts 1 week and 4 days
[T5 (2 weeks)] lasts 2 weeks
@endgantt
```

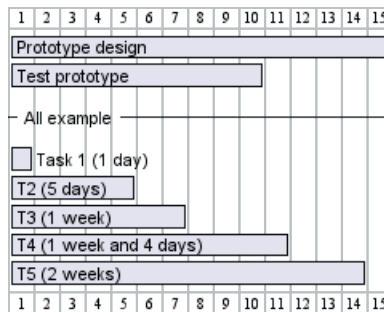

Une semaine est un synonyme du nombre de jours non fermés dans une semaine. Ainsi, si vous spécifiez que le samedi et le dimanche sont fermés, une semaine équivaudra à 5 jours

16.1.2 Start

Leurs débuts sont définis à l'aide du verbe `start`

```
@startgantt
language fr

[Prototype design] lasts 15 days
[Test prototype] lasts 10 days

Project starts 2020-07-01
[Prototype design] starts 2020-07-01
[Test prototype] starts 2020-07-16
@endgantt
```

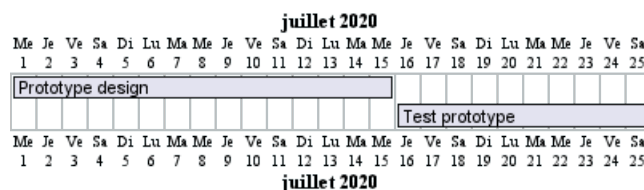

16.1.3 End

Leur fin est définie à l'aide du verbe `end`



```

@startgantt
language fr

[Prototype design] lasts 15 days
[Test prototype] lasts 10 days

Project starts 2020-07-01
[Prototype design] ends 2020-07-15
[Test prototype] ends 2020-07-25

@endgantt

```

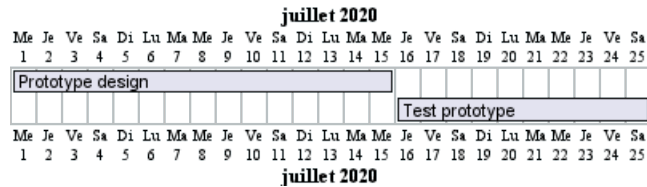

16.1.4 Début/Fin

Il est possible de définir les deux de manière absolue, en spécifiant des dates

```

@startgantt
language fr

Project starts 2020-07-01
[Prototype design] starts 2020-07-01
[Test prototype] starts 2020-07-16
[Prototype design] ends 2020-07-15
[Test prototype] ends 2020-07-25

@endgantt

```

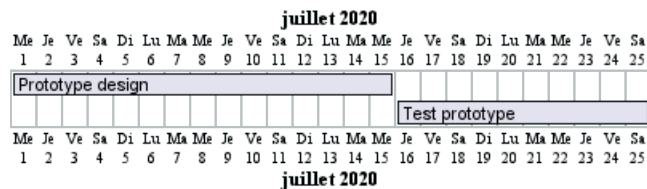

16.2 Déclaration sur une ligne (avec la conjonction et)

Il est possible de combiner une déclaration sur une ligne avec la conjonction **and**

```

@startgantt
language fr
Project starts 2020-07-01
[Prototype design] starts 2020-07-01 and ends 2020-07-15
[Test prototype] starts 2020-07-16 and lasts 10 days
@endgantt

```

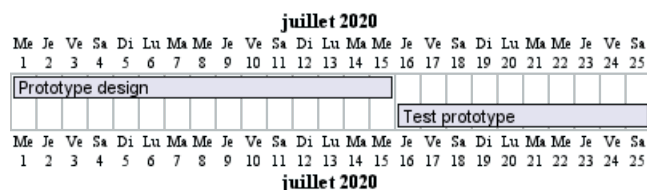

16.3 Ajout de contraintes

Il est possible d'ajouter des contraintes entre les tâches

```
@startgantt
[Prototype design] lasts 15 days
[Test prototype] lasts 10 days
[Test prototype] starts at [Prototype design]'s end
@endgantt
```

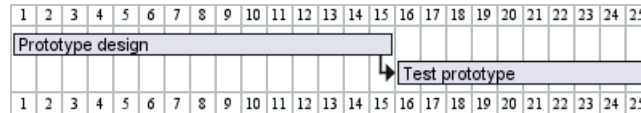

```
@startgantt
[Prototype design] lasts 10 days
[Code prototype] lasts 10 days
[Write tests] lasts 5 days
[Code prototype] starts at [Prototype design]'s end
[Write tests] starts at [Code prototype]'s start
@endgantt
```

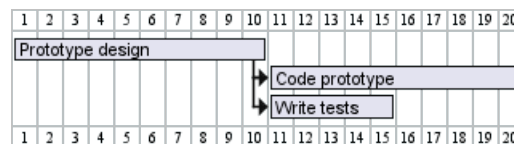

16.4 Noms courts (avec : as)

Un nom court peut être utilisé pour les tâches à l'aide de l'instruction `as`.

```
@startgantt
[Design du prototype] as [D] lasts 15 days
[Test du prototype] as [T] lasts 10 days
[T] starts at [D]'s end
@endgantt
```

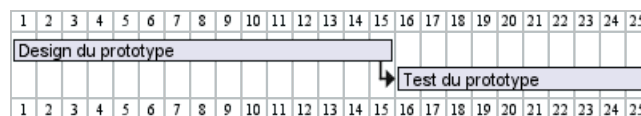

16.5 Choix des couleurs

Il est possible de changer les couleurs des tâches avec les mots clés `is colored in`.

```
@startgantt
[Design du prototype] lasts 13 days
[Test du prototype] lasts 4 days
[Test du prototype] starts at [Design du prototype]'s end
[Design du prototype] is colored in Fuchsia/FireBrick
[Test du prototype] is colored in GreenYellow/Green
@endgantt
```

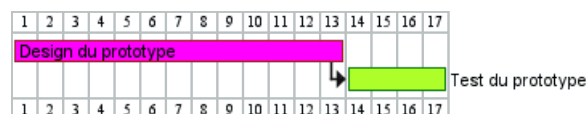

16.6 Complétion d'une tâche

16.6.1 Ajout du pourcentage d'achèvement

Vous pouvez définir l'état d'achèvement d'une tâche, par la commande :

- is xx% completed
- is xx% complete

```
@startgantt
[foo] lasts 21 days
[foo] is 40% completed
[bar] lasts 30 days and is 10% complete
@endgantt
```

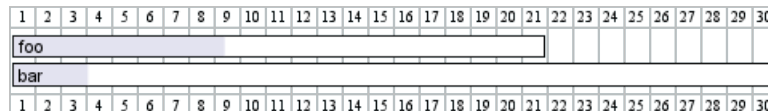

16.6.2 Changer la couleur de l'achèvement (par style)

```
@startgantt
```

```
<style>
ganttdiagram {
  task {
    BackgroundColor GreenYellow
    LineColor Green
    unstarted {
      BackgroundColor Fuchsia
      LineColor FireBrick
    }
  }
}
</style>
```

```
[Prototype design] lasts 7 days
[Test prototype 0] lasts 4 days
[Test prototype 10] lasts 4 days
[Test prototype 20] lasts 4 days
[Test prototype 30] lasts 4 days
[Test prototype 40] lasts 4 days
[Test prototype 50] lasts 4 days
[Test prototype 60] lasts 4 days
[Test prototype 70] lasts 4 days
[Test prototype 80] lasts 4 days
[Test prototype 90] lasts 4 days
[Test prototype 100] lasts 4 days
```

```
[Test prototype 0] starts at [Prototype design]'s end
[Test prototype 10] starts at [Prototype design]'s end
[Test prototype 20] starts at [Prototype design]'s end
[Test prototype 30] starts at [Prototype design]'s end
[Test prototype 40] starts at [Prototype design]'s end
[Test prototype 50] starts at [Prototype design]'s end
[Test prototype 60] starts at [Prototype design]'s end
[Test prototype 70] starts at [Prototype design]'s end
[Test prototype 80] starts at [Prototype design]'s end
[Test prototype 90] starts at [Prototype design]'s end
[Test prototype 100] starts at [Prototype design]'s end
```



```

[Test prototype 0] is 0% complete
[Test prototype 10] is 10% complete
[Test prototype 20] is 20% complete
[Test prototype 30] is 30% complete
[Test prototype 40] is 40% complete
[Test prototype 50] is 50% complete
[Test prototype 60] is 60% complete
[Test prototype 70] is 70% complete
[Test prototype 80] is 80% complete
[Test prototype 90] is 90% complete
[Test prototype 100] is 100% complete

```

```
@endgantt
```

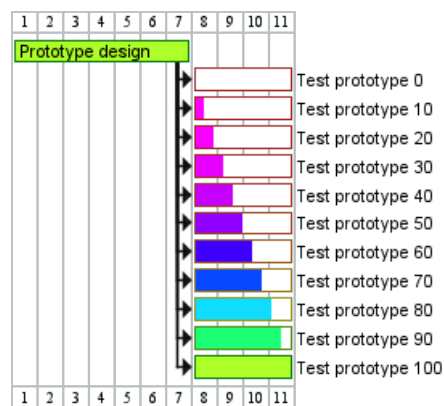

[Ref. QA-8297]

16.7 Jalon (avec le verbe : happen)

Vous pouvez définir des jalons à l'aide du verbe happen.

16.7.1 Jalon relatif (avec utilisation de contraintes sur des tâches)

```
@startgantt
```

```

[Test du prototype] lasts 10 days
[Prototype terminé] happens at [Test du prototype]'s end
[Mise en place production] lasts 12 days
[Mise en place production] starts at [Test du prototype]'s end
@endgantt

```



16.7.2 Jalon absolu (avec utilisation d'un date fixe)

```
@startgantt
```

```

language fr
Project starts 2020-07-01
[Test prototype] lasts 10 days
[Prototype completed] happens 2020-07-10
[Setup assembly line] lasts 12 days
[Setup assembly line] starts at [Test prototype]'s end
@endgantt

```



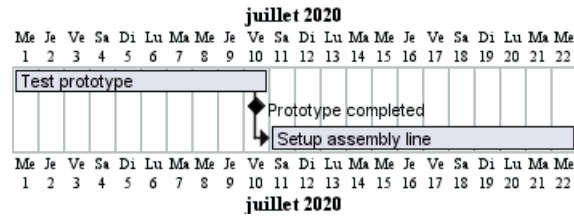

16.7.3 Jalon de fin maximale de tâches

```
@startgantt
[Task1] lasts 4 days
then [Task1.1] lasts 4 days
[Task1.2] starts at [Task1]'s end and lasts 7 days
```

```
[Task2] lasts 5 days
then [Task2.1] lasts 4 days
```

```
[MaxTaskEnd] happens at [Task1.1]'s end
[MaxTaskEnd] happens at [Task1.2]'s end
[MaxTaskEnd] happens at [Task2.1]'s end
```

```
@endgantt
```

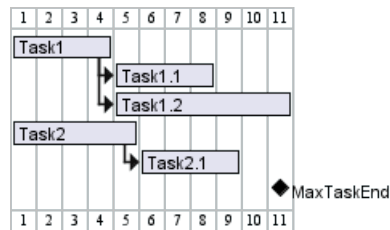

[Ref. QA-10764]

16.8 Lien hypertexte

On peut rajouter des liens aux tâches avec le mot clé `links to`.

```
@startgantt
[task1] lasts 10 days
[task1] links to [[http://plantuml.com]]
@endgantt
```

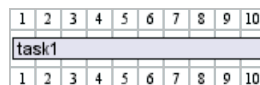

16.9 Calendrier

Vous pouvez spécifier une date de début pour l'ensemble du projet. Par défaut, la première tâche commence à cette date

```
@startgantt
language fr
Project starts the 20th of september 2017
[Prototype design] as [TASK1] lasts 13 days
[TASK1] is colored in Lavender/LightBlue
@endgantt
```





16.10 Journées en couleur

Il est possible d'ajouter des couleurs à certaines journées

```
@startgantt
Language fr
Project starts the 2020/09/01
```

```
2020/09/07 is colored in salmon
2020/09/13 to 2020/09/16 are colored in lightblue
```

```
[Prototype design] as [TASK1] lasts 22 days
[TASK1] is colored in Lavender/LightBlue
[Prototype completed] happens at [TASK1]'s end
@endgantt
```



16.11 Changement d'échelle

Vous pouvez changer d'échelle pour les projets de très longue durée, avec l'un des paramètres suivants :

- printscale
- ganttyscale
- projectyscale

et l'une des valeurs suivantes :

- daily (*par défaut*)
- weekly
- monthly
- quarterly
- yearly

(Voir QA-11272, QA-9041 et QA-10948)

16.11.1 Daily (*par défaut*)

```
@startgantt
Language fr
saturday are closed
sunday are closed
```

```
Project starts the 1st of january 2021
[Prototype design end] as [TASK1] lasts 19 days
[TASK1] is colored in Lavender/LightBlue
[Testing] lasts 14 days
[TASK1]->[Testing]
```



2021-01-18 to 2021-01-22 are named [End's committee]
 2021-01-18 to 2021-01-22 are colored in salmon
 @endgantt

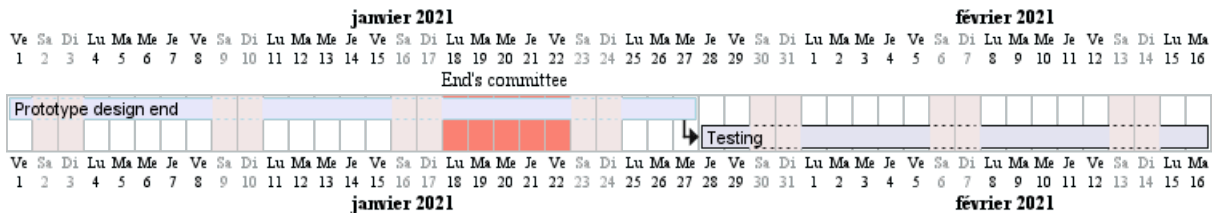

16.11.2 Hebdomadaire

@startgantt
 Language fr
 printscale weekly
 saturday are closed
 sunday are closed

Project starts the 1st of January 2021
 [Prototype design end] as [TASK1] lasts 19 days
 [TASK1] is colored in Lavender/LightBlue
 [Testing] lasts 14 days
 [TASK1]->[Testing]

2021-01-18 to 2021-01-22 are named [End's committee]
 2021-01-18 to 2021-01-22 are colored in salmon
 @endgantt

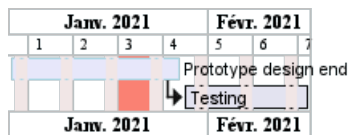

@startgantt
 Language fr
 printscale weekly
 Project starts the 20th of september 2020
 [Prototype design] as [TASK1] lasts 130 days
 [TASK1] is colored in Lavender/LightBlue
 [Testing] lasts 20 days
 [TASK1]->[Testing]

2021-01-18 to 2021-01-22 are named [End's committee]
 2021-01-18 to 2021-01-22 are colored in salmon
 @endgantt

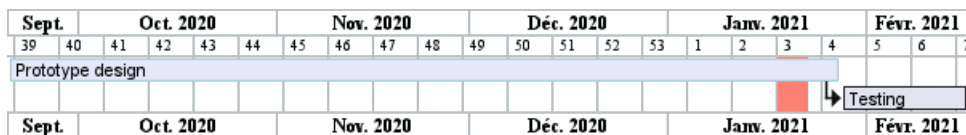

16.11.3 Mensuel

@startgantt
 Language fr
 projectscale monthly
 Project starts the 20th of september 2020



[Prototype design] as [TASK1] lasts 130 days
 [TASK1] is colored in Lavender/LightBlue
 [Testing] lasts 20 days
 [TASK1]->[Testing]

2021-01-18 to 2021-01-22 are named [End's committee]
 2021-01-18 to 2021-01-22 are colored in salmon
 @endganttt

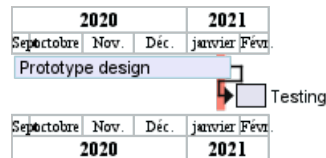

16.11.4 Trimestriel

@startganttt
 Language fr
 projectscale quarterly
 Project starts the 20th of september 2020
 [Prototype design] as [TASK1] lasts 130 days
 [TASK1] is colored in Lavender/LightBlue
 [Testing] lasts 20 days
 [TASK1]->[Testing]

2021-01-18 to 2021-01-22 are named [End's committee]
 2021-01-18 to 2021-01-22 are colored in salmon
 @endganttt

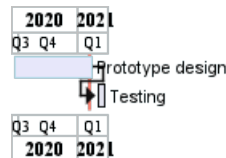

@startganttt
 Language fr
 projectscale quarterly
 Project starts the 1st of october 2020
 [Prototype design] as [TASK1] lasts 700 days
 [TASK1] is colored in Lavender/LightBlue
 [Testing] lasts 200 days
 [TASK1]->[Testing]

2021-01-18 to 2021-03-22 are colored in salmon
 @endganttt

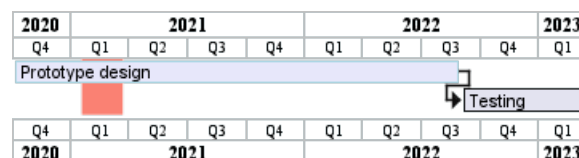

16.11.5 Annuel

@startganttt
 Language fr
 projectscale yearly
 Project starts the 1st of october 2020
 [Prototype design] as [TASK1] lasts 700 days



```
[TASK1] is colored in Lavender/LightBlue
[Testing] lasts 200 days
[TASK1]->[Testing]
```

```
2021-01-18 to 2021-03-22 are colored in salmon
@endgantt
```

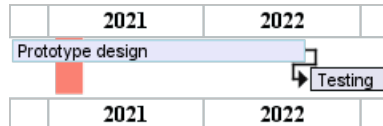

16.12 Zoom (exemple pour toutes les échelles)

Vous pouvez modifier le zoom, avec le paramètre :

- zoom <integer>

16.12.1 Zoom sur l'échelle hebdomadaire

16.12.2 Sans zoom

```
@startgantt
Language fr
printscale daily
saturday are closed
sunday are closed
```

```
Project starts the 1st of january 2021
[Prototype design end] as [TASK1] lasts 8 days
[TASK1] is colored in Lavender/LightBlue
[Testing] lasts 3 days
[TASK1]->[Testing]
```

```
2021-01-18 to 2021-01-22 are named [End's committee]
2021-01-18 to 2021-01-22 are colored in salmon
@endgantt
```

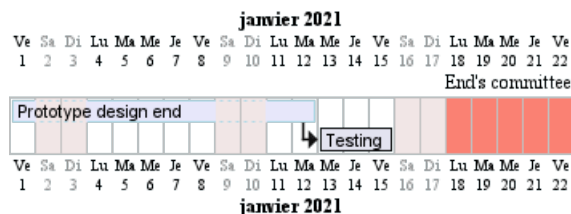

16.12.3 Avec zoom

```
@startgantt
Language fr
printscale daily zoom 2
saturday are closed
sunday are closed
```

```
Project starts the 1st of january 2021
[Prototype design end] as [TASK1] lasts 8 days
[TASK1] is colored in Lavender/LightBlue
[Testing] lasts 3 days
[TASK1]->[Testing]
```

```
2021-01-18 to 2021-01-22 are named [End's committee]
```



2021-01-18 to 2021-01-22 are colored in salmon
 @endgantt

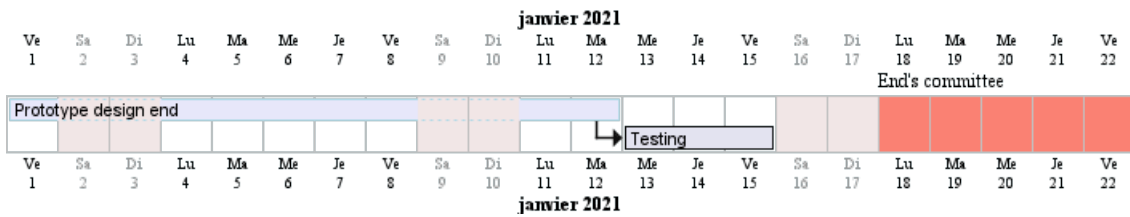

[Ref. QA-13725]

16.12.4 Zoom sur l'échelle hebdomadaire

16.12.5 Sans zoom

@startgantt
 Language fr
 printscale weekly
 saturday are closed
 sunday are closed

Project starts the 1st of January 2021
 [Prototype design end] as [TASK1] lasts 19 days
 [TASK1] is colored in Lavender/LightBlue
 [Testing] lasts 14 days
 [TASK1]->[Testing]

2021-01-18 to 2021-01-22 are named [End's committee]
 2021-01-18 to 2021-01-22 are colored in salmon
 @endgantt

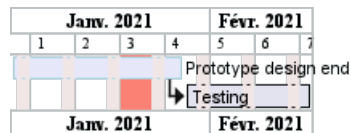

16.12.6 Avec zoom

@startgantt
 Language fr
 printscale weekly zoom 4
 saturday are closed
 sunday are closed

Project starts the 1st of January 2021
 [Prototype design end] as [TASK1] lasts 19 days
 [TASK1] is colored in Lavender/LightBlue
 [Testing] lasts 14 days
 [TASK1]->[Testing]

2021-01-18 to 2021-01-22 are named [End's committee]
 2021-01-18 to 2021-01-22 are colored in salmon
 @endgantt

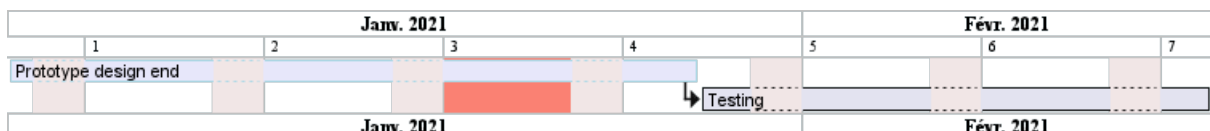

16.12.7 Zoom sur l'échelle mensuelle

16.12.8 Sans zoom

```
@startgantt
Language fr
projectscale monthly
Project starts the 20th of september 2020
[Prototype design] as [TASK1] lasts 130 days
[TASK1] is colored in Lavender/LightBlue
[Testing] lasts 20 days
[TASK1]->[Testing]
```

2021-01-18 to 2021-01-22 are named [End's committee]

2021-01-18 to 2021-01-22 are colored in salmon

```
@endgantt
```

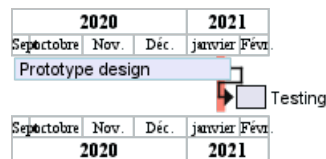

16.12.9 Avec zoom

```
@startgantt
Language fr
projectscale monthly zoom 3
Project starts the 20th of september 2020
[Prototype design] as [TASK1] lasts 130 days
[TASK1] is colored in Lavender/LightBlue
[Testing] lasts 20 days
[TASK1]->[Testing]
```

2021-01-18 to 2021-01-22 are named [End's committee]

2021-01-18 to 2021-01-22 are colored in salmon

```
@endgantt
```

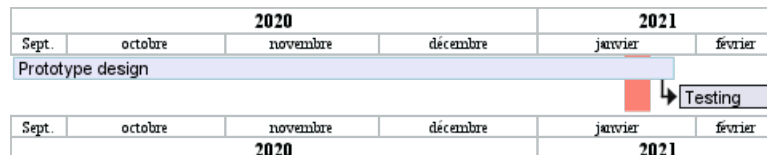

16.12.10 Zoom sur l'échelle trimestrielle

16.12.11 Sans zoom

```
@startgantt
Language fr
projectscale quarterly
Project starts the 20th of september 2020
[Prototype design] as [TASK1] lasts 130 days
[TASK1] is colored in Lavender/LightBlue
[Testing] lasts 20 days
[TASK1]->[Testing]
```

2021-01-18 to 2021-01-22 are named [End's committee]

2021-01-18 to 2021-01-22 are colored in salmon

```
@endgantt
```



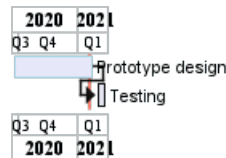

16.12.12 Avec zoom

```
@startgantt
Language fr
projectscale quarterly zoom 7
Project starts the 20th of september 2020
[Prototype design] as [TASK1] lasts 130 days
[TASK1] is colored in Lavender/LightBlue
[Testing] lasts 20 days
[TASK1]->[Testing]
```

2021-01-18 to 2021-01-22 are named [End's committee]

2021-01-18 to 2021-01-22 are colored in salmon

```
@endgantt
```

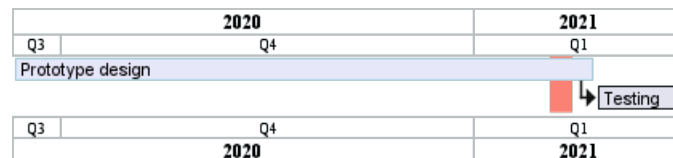

16.12.13 Zoom sur l'échelle annuelle

16.12.14 Sans zoom

```
@startgantt
Language fr
projectscale yearly
Project starts the 1st of october 2020
[Prototype design] as [TASK1] lasts 700 days
[TASK1] is colored in Lavender/LightBlue
[Testing] lasts 200 days
[TASK1]->[Testing]
```

2021-01-18 to 2021-03-22 are colored in salmon

```
@endgantt
```

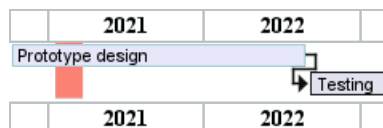

16.12.15 Avec zoom

```
@startgantt
Language fr
projectscale yearly zoom 2
Project starts the 1st of october 2020
[Prototype design] as [TASK1] lasts 700 days
[TASK1] is colored in Lavender/LightBlue
[Testing] lasts 200 days
[TASK1]->[Testing]
```

2021-01-18 to 2021-03-22 are colored in salmon



```
@endgantt
```

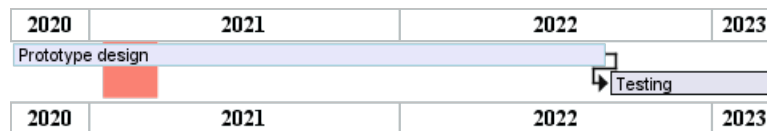

16.13 Weekscale with Weeknumbers or Calendar Date

16.13.1 With Weeknumbers (*by default*)

```
@startgantt
printscale weekly
Project starts the 6th of July 2020
[Task1] on {Alice} lasts 2 weeks
[Task2] on {Bob:50%} lasts 2 weeks
then [Task3] on {Alice:25%} lasts 3 days
@endgantt
```

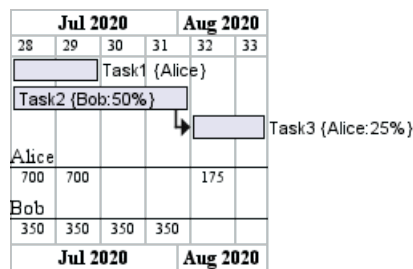

16.13.2 With Calendar Date

```
@startgantt
printscale weekly with calendar date
Project starts the 6th of July 2020
[Task1] on {Alice} lasts 2 weeks
[Task2] on {Bob:50%} lasts 2 weeks
then [Task3] on {Alice:25%} lasts 3 days
@endgantt
```

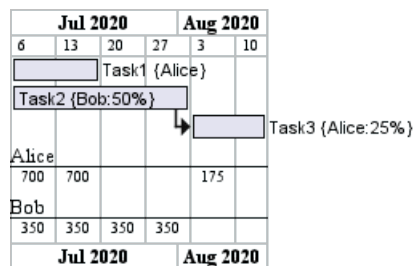

[Ref. QA-11630]

16.14 Jours non travaillés

Il est possible de déclarer certains jours comme non travaillés.

```
@startgantt
project starts the 2018/04/09
saturday are closed
sunday are closed
2018/05/01 is closed
2018/04/17 to 2018/04/19 is closed
[Prototype design] lasts 14 days
[Test prototype] lasts 4 days
```



```
[Test prototype] starts at [Prototype design]'s end
[Prototype design] is colored in Fuchsia/FireBrick
[Test prototype] is colored in GreenYellow/Green
@endganttt
```

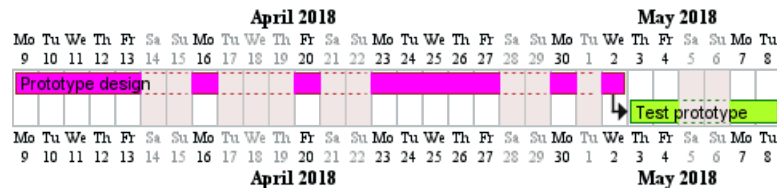

Puis il est possible de déclarer certains jours non travaillés, comme finalement, travaillés.

```
@startganttt
2020-07-07 to 2020-07-17 is closed
2020-07-13 is open
```

```
Project starts the 2020-07-01
[Prototype design] lasts 10 days
Then [Test prototype] lasts 10 days
@endganttt
```



16.15 Définition d'une semaine en fonction des jours fermés

Une **semaine** est un synonyme du nombre de jours non fermés qu'il y a dans une semaine, comme :

```
@startganttt
Language fr
Project starts 2021-03-29
[Review 01] happens at 2021-03-29
[Review 02 - 3 weeks] happens on 3 weeks after [Review 01]'s end
[Review 02 - 21 days] happens on 21 days after [Review 01]'s end
@endganttt
```

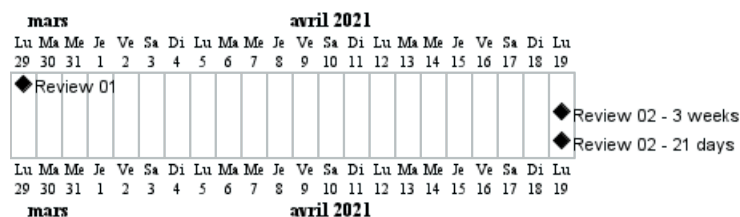

Ainsi, si vous spécifiez que le *samedi* et le *dimanche* sont fermés, une **semaine** équivaudra à 5 jours, comme :

```
@startganttt
Language fr
Project starts 2021-03-29
saturday are closed
sunday are closed
[Review 01] happens at 2021-03-29
[Review 02 - 3 weeks] happens on 3 weeks after [Review 01]'s end
[Review 02 - 21 days] happens on 21 days after [Review 01]'s end
@endganttt
```



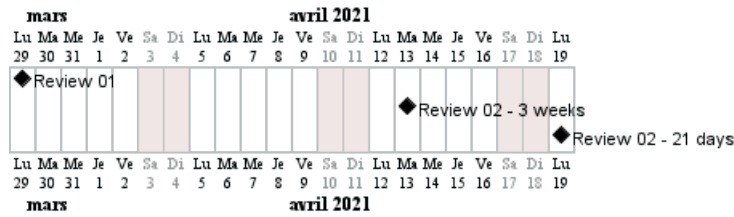

[Réf. QA-13434]

16.16 Working days

It is possible to manage working days.

```
@startgantt
```

```
saturday are closed
```

```
sunday are closed
```

```
2022-07-04 to 2022-07-15 is closed
```

```
Project starts 2022-06-27
```

```
[task1] starts at 2022-06-27 and lasts 1 week
```

```
[task2] starts 2 working days after [task1]'s end and lasts 3 days
```

```
@endgantt
```

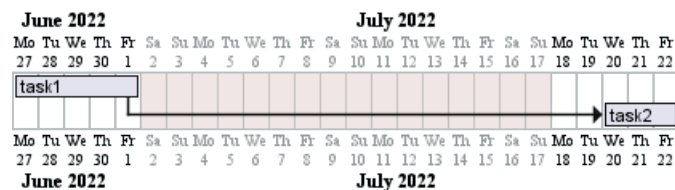

[Ref. QA-16188]

16.17 Succession des tâches simplifiée et dépendances

Il est possible d'utiliser le mot-clés `then` pour définir des tâches consécutives.

```
@startgantt
```

```
[Prototype design] lasts 14 days
```

```
then [Test prototype] lasts 4 days
```

```
then [Deploy prototype] lasts 6 days
```

```
@endgantt
```

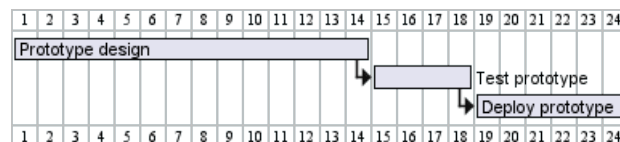

Vous pouvez aussi utiliser une flèche `->`.

```
@startgantt
```

```
[Prototype design] lasts 14 days
```

```
[Build prototype] lasts 4 days
```

```
[Prepare test] lasts 6 days
```

```
[Prototype design] -> [Build prototype]
```

```
[Prototype design] -> [Prepare test]
```

```
@endgantt
```



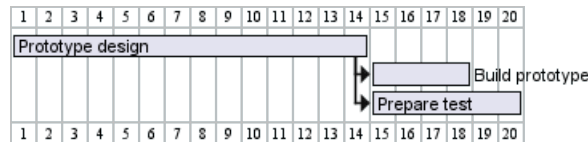

16.18 Travailler avec des ressources

Vous pouvez affecter des ressources aux tâches à l'aide du mot-clé `on` et en mettant le nom de la ressource entre accolades. Vous pouvez aussi rajouter un taux de charge en pourcentage.

```
@startgantt
[Task1] on {Alice} lasts 10 days
[Task2] on {Bob:50%} lasts 2 days
then [Task3] on {Alice:25%} lasts 1 days
@endgantt
```

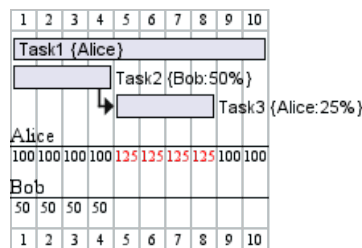

Plusieurs ressources peuvent être affectées à une tâche :

```
@startgantt
[Task1] on {Alice} {Bob} lasts 20 days
@endgantt
```

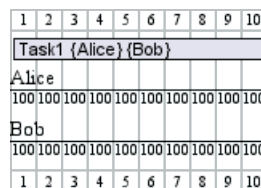

Les ressources peuvent être marquées comme inopérantes certains jours:

```
@startgantt
Language fr
project starts on 2020-06-19
[Task1] on {Alice} lasts 10 days
{Alice} is off on 2020-06-24 to 2020-06-26
@endgantt
```



16.19 Hide resources

16.19.1 Without any hiding (by default)

```
@startgantt
[Task1] on {Alice} lasts 10 days
[Task2] on {Bob:50%} lasts 2 days
then [Task3] on {Alice:25%} lasts 1 days
```



```
then [Task4] on {Alice:25%} {Bob} lasts 1 days
@endgantt
```



16.19.2 Hide resources names

You can hide resources names and percentage, on tasks, using the `hide resources names` keywords.

```
@startgantt
hide resources names
[Task1] on {Alice} lasts 10 days
[Task2] on {Bob:50%} lasts 2 days
then [Task3] on {Alice:25%} lasts 1 days
then [Task4] on {Alice:25%} {Bob} lasts 1 days
@endgantt
```

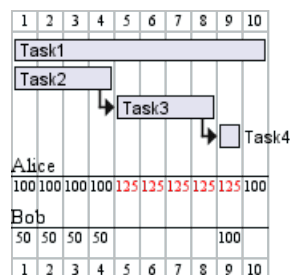

16.19.3 Hide resources footbox

You can also hide resources names on bottom of the diagram using the `hide resources footbox` keywords.

```
@startgantt
hide resources footbox
[Task1] on {Alice} lasts 10 days
[Task2] on {Bob:50%} lasts 2 days
then [Task3] on {Alice:25%} lasts 1 days
then [Task4] on {Alice:25%} {Bob} lasts 1 days
@endgantt
```

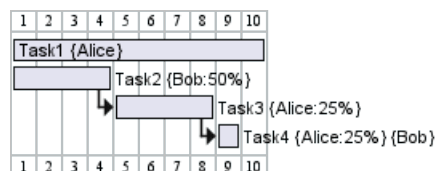

16.19.4 Hide the both (resources names and resources footbox)

You can also hide the both.

```
@startgantt
hide resources names
hide resources footbox
[Task1] on {Alice} lasts 10 days
```



```

[Task2] on {Bob:50%} lasts 2 days
then [Task3] on {Alice:25%} lasts 1 days
then [Task4] on {Alice:25%} {Bob} lasts 1 days
@endgantt

```

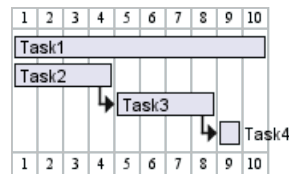

16.20 Séparateur

Il est possible d'utiliser `--` pour séparer ou grouper des tâches ensemble.

```

@startgantt
[Task1] lasts 10 days
then [Task2] lasts 4 days
-- Phase Two --
then [Task3] lasts 5 days
then [Task4] lasts 6 days
@endgantt

```

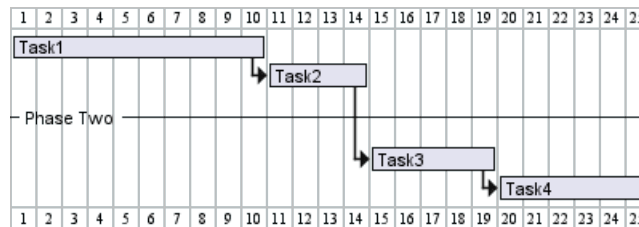

16.21 Vertical Separator

You can add Vertical Separators with the syntax: `Separator just [at]`.

```

@startgantt
[task1] lasts 1 week
[task2] starts 20 days after [task1]'s end and lasts 3 days

```

```

Separator just at [task1]'s end
Separator just 2 days after [task1]'s end

```

```

Separator just at [task2]'s start
Separator just 2 days before [task2]'s start
@endgantt

```

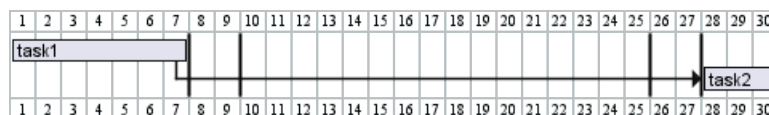

[Ref. QA-16247]

16.22 Exemple plus complexe

On peut se servir de la conjonction de coordination `and`.

Il est aussi possible de spécifier un délai (avec `before` ou `after`) dans les contraintes.

```

@startgantt
[Design du prototype] lasts 13 days and is colored in Lavender/LightBlue
[Test du prototype] lasts 9 days and is colored in Coral/Green and starts 3 days after [Design du pr

```



```

[Écriture des tests] lasts 5 days and ends at [Design du prototype]'s end
[Embauche rédacteurs] lasts 6 days and ends at [Écriture des tests]'s start
[Ecriture des rapports] is colored in Coral/Green
[Ecriture des rapports] starts 1 day before [Test du prototype]'s start and ends at [Test du prototype]'s end
@endgantt

```

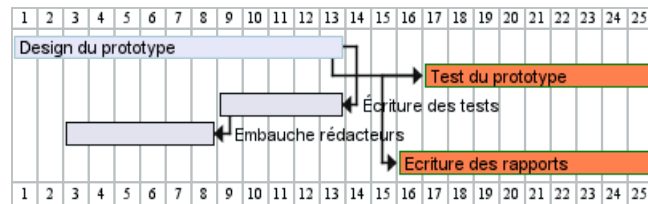

16.23 Comments

As is mentioned on Common Commands page: `blockquote` Everything that starts with `simple quote` ' is a comment.

You can also put comments on several lines using `/'` to start and `/'` to end. `blockquote` (i.e.: the first character (except space character) of a comment line must be a *simple quote* ')

```

@startgantt
' This is a comment

```

```

[T1] lasts 3 days

```

```

/' this comment
is on several lines '/'

```

```

[T2] starts at [T1]'s end and lasts 1 day
@endgantt

```

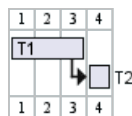

16.24 Avec style

16.24.1 Sans style (par défaut)

```

@startgantt
[Task1] lasts 20 days
note bottom
  memo1 ...
  memo2 ...
  explanations1 ...
  explanations2 ...
end note
[Task2] lasts 4 days
[Task1] -> [Task2]
-- Separator title --
[M1] happens on 5 days after [Task1]'s end
-- end --
@endgantt

```



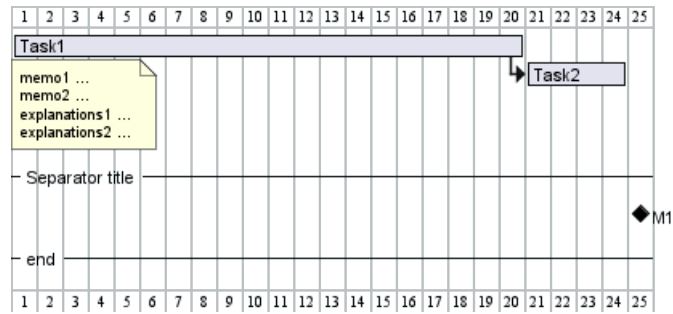

16.24.2 Avec style

Vous pouvez utiliser le style pour modifier le rendu des éléments

```

@startgantt
<style>
ganttdiagram {
task {
FontName Helvetica
FontColor red
FontSize 18
FontStyle bold
BackgroundColor GreenYellow
LineColor blue
}
milestone {
FontColor blue
FontSize 25
FontStyle italic
BackgroundColor yellow
LineColor red
}
note {
FontColor DarkGreen
FontSize 10
LineColor OrangeRed
}
arrow {
FontName Helvetica
FontColor red
FontSize 18
FontStyle bold
BackgroundColor GreenYellow
LineColor blue
}
separator {
LineColor red
BackgroundColor green
FontSize 16
FontStyle bold
FontColor purple
}
}
</style>
[Task1] lasts 20 days
note bottom
memo1 ...
memo2 ...

```



```

    explanations1 ...
    explanations2 ...
end note
[Task2] lasts 4 days
[Task1] -> [Task2]
-- Separator title --
[M1] happens on 5 days after [Task1]'s end
-- end --
@endgantt

```

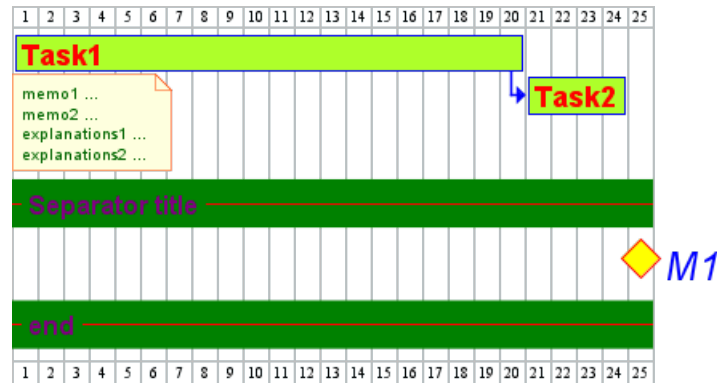

[Réf. QA-10835, QA-12045, QA-11877 et PR-438]

16.24.3 Avec style (exemple complet)

```

@startgantt
<style>
ganttDiagram {
task {
FontName Helvetica
FontColor red
FontSize 18
FontStyle bold
BackgroundColor GreenYellow
LineColor blue
}
milestone {
FontColor blue
FontSize 25
FontStyle italic
BackgroundColor yellow
LineColor red
}
note {
FontColor DarkGreen
FontSize 10
LineColor OrangeRed
}
arrow {
FontName Helvetica
FontColor red
FontSize 18
FontStyle bold
BackgroundColor GreenYellow
LineColor blue
LineStyle 8.0;13.0
LineThickness 3.0
}

```



```

separator {
  BackgroundColor lightGreen
  LineStyle 8.0;3.0
  LineColor red
  LineThickness 1.0
  FontSize 16
  FontStyle bold
  FontColor purple
  Margin 5
  Padding 20
}
timeline {
  BackgroundColor Bisque
}
closed {
  BackgroundColor pink
  FontColor red
}
}
</style>
Project starts the 2020-12-01

[Task1] lasts 10 days
sunday are closed

note bottom
  memo1 ...
  memo2 ...
  explanations1 ...
  explanations2 ...
end note

[Task2] lasts 20 days
[Task2] starts 10 days after [Task1]'s end
-- Separator title --
[M1] happens on 5 days after [Task1]'s end

<style>
separator {
  LineColor black
  Margin 0
  Padding 0
}
</style>

-- end --
@endgantt

```

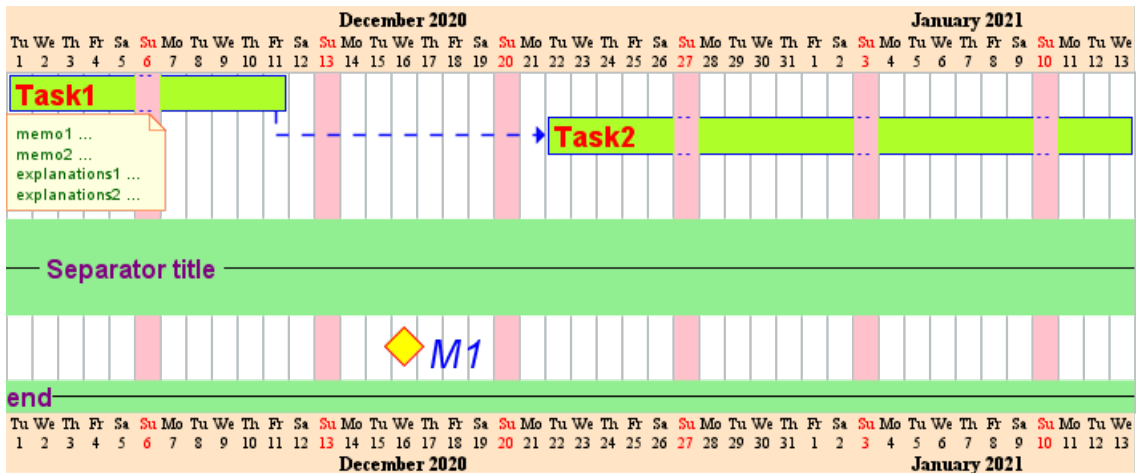

[Réf. QA-13570, QA-13672]

TODO: FAIT Merci pour le style pour le Séparateur et tous les styles pour la Flèche (épaisseur...)

16.24.4 Nettoyer le style

Avec le style, vous pouvez également nettoyer un diagramme de Gantt (montrant uniquement les tâches, les dépendances et les durées relatives - mais pas de date de début réelle et pas d'échelle réelle):

```
@startgantt
<style>
ganttdiagram {
  timeline {
    LineColor transparent
    FontColor transparent
  }
}
</style>

hide footbox
[Test prototype] lasts 7 days
[Prototype completed] happens at [Test prototype]'s end
[Setup assembly line] lasts 9 days
[Setup assembly line] starts at [Test prototype]'s end
then [Setup] lasts 5 days
[T2] lasts 2 days and starts at [Test prototype]'s end
then [T3] lasts 3 days
-- end task --
then [T4] lasts 2 days
@endgantt
```

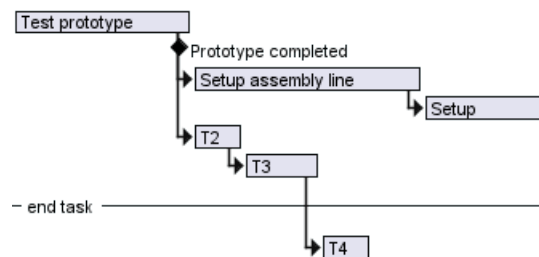

[Réf. QA-13971]

Ou :

```
@startgantt
```



```

<style>
ganttdiagram {
  timeline {
    LineColor transparent
    FontColor transparent
  }
  closed {
    FontColor transparent
  }
}
</style>

hide footbox
project starts the 2018/04/09
saturday are closed
sunday are closed
2018/05/01 is closed
2018/04/17 to 2018/04/19 is closed
[Prototype design] lasts 9 days
[Test prototype] lasts 5 days
[Test prototype] starts at [Prototype design]'s end
[Prototype design] is colored in Fuchsia/FireBrick
[Test prototype] is colored in GreenYellow/Green
@endganttt

```

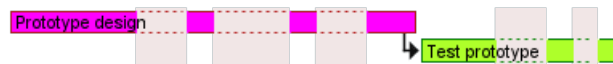

[Réf. QA-13464]

16.25 Ajouter des notes

```

@startgantt
[task01] lasts 15 days
note bottom
  memo1 ...
  memo2 ...
  explanations1 ...
  explanations2 ...
end note

[task01] -> [task02]

@endganttt

```

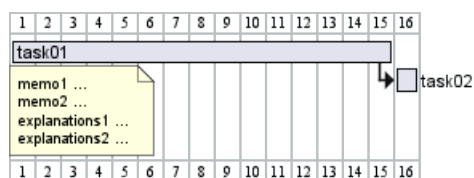

Exemple avec chevauchement

```

@startgantt
[task01] lasts 15 days
note bottom
  memo1 ...
  memo2 ...
end note

```



```

    explanations1 ...
    explanations2 ...
end note

```

```

[task01] -> [task02]
[task03] lasts 5 days

```

```
@endgantt
```

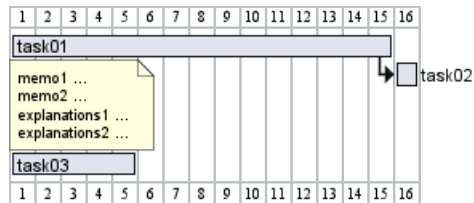

```
@startgantt
```

```
-- test01 --
```

```

[task01] lasts 4 days
note bottom
'note left
memo1 ...
memo2 ...
explanations1 ...
explanations2 ...
end note

```

```

[task02] lasts 8 days
[task01] -> [task02]
note bottom
'note left
memo1 ...
memo2 ...
explanations1 ...
explanations2 ...
end note
-- test02 --

```

```

[task03] as [t3] lasts 7 days
[t3] -> [t4]
@endgantt

```

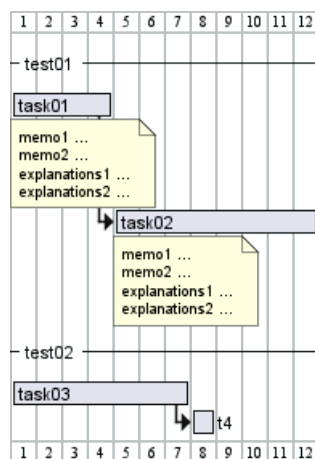

TODO: FAIT *Merci pour la correction (de #386 sur la v1.2020.18) lors d'un chevauchement*

```

@startgantt
Language fr
Project starts 2020-09-01

[taskA] starts 2020-09-01 and lasts 3 days
[taskB] starts 2020-09-10 and lasts 3 days
[taskB] displays on same row as [taskA]

[task01] starts 2020-09-05 and lasts 4 days

then [task02] lasts 8 days
note bottom
  note for task02
  more notes
end note

then [task03] lasts 7 days
note bottom
  note for task03
  more notes
end note

-- separator --

[taskC] starts 2020-09-02 and lasts 5 days
[taskD] starts 2020-09-09 and lasts 5 days
[taskD] displays on same row as [taskC]

[task 10] starts 2020-09-05 and lasts 5 days
then [task 11] lasts 5 days
note bottom
  note for task11
  more notes
end note
@endgantt
    
```

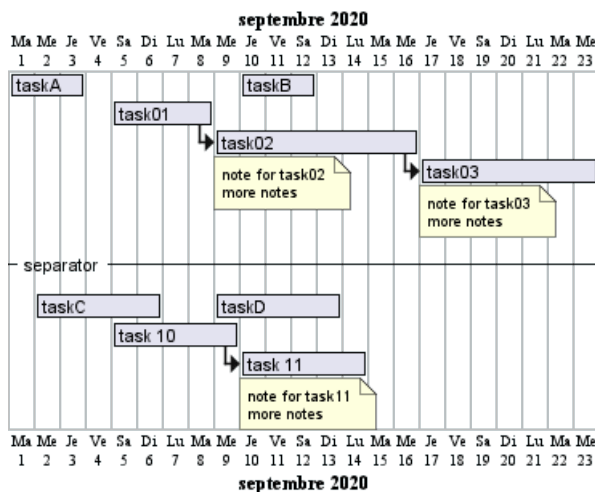

16.26 Pause des tâches

```

@startgantt
Language fr
Project starts the 5th of december 2018
    
```



```

saturday are closed
sunday are closed
2018/12/29 is opened
[Prototype design] lasts 17 days
[Prototype design] pauses on 2018/12/13
[Prototype design] pauses on 2018/12/14
[Prototype design] pauses on monday
[Test prototype] starts at [Prototype design]'s end and lasts 2 weeks
@endgant

```

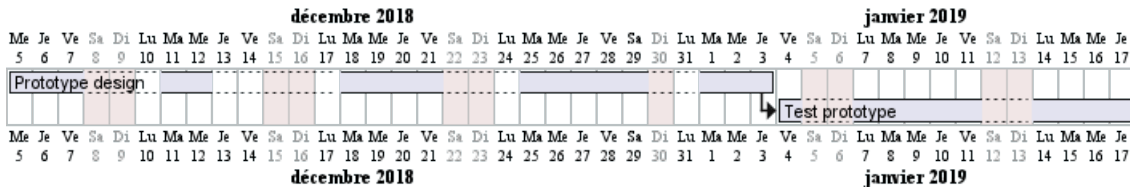

16.27 Modifier les couleurs des liens

Vous pouvez modifier les couleurs des liens :

- avec cette syntaxe : `with <color> <style> link`

```

@startgant
[T1] lasts 4 days
[T2] lasts 4 days and starts 3 days after [T1]'s end with blue dotted link
[T3] lasts 4 days and starts 3 days after [T2]'s end with green bold link
[T4] lasts 4 days and starts 3 days after [T3]'s end with green dashed link
@endgant

```

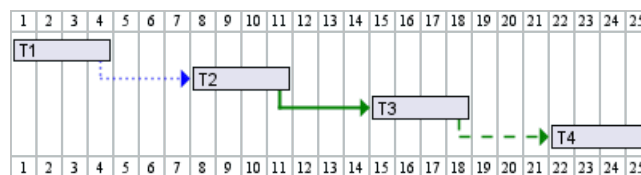

- ou directement en utilisant le style flèche

```

@startgant
<style>
gantDiagram {
  arrow {
    LineColor blue
  }
}
</style>
[Prototype design] lasts 7 days
[Build prototype] lasts 4 days
[Prepare test] lasts 6 days
[Prototype design] -[#FF00FF]-> [Build prototype]
[Prototype design] -[dotted]-> [Prepare test]
Then [Run test] lasts 4 days
@endgant

```

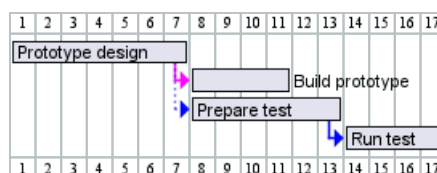

[Réf. QA-13693]



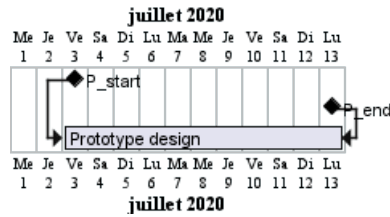

16.31 Grammar and verbal form

Verbal form	Example
[<i>T</i>] starts	
[<i>M</i>] happens	

16.32 Ajouter un titre, un en-tête, un pied de page, une légende ou un sous-titre

```
@startgantt
```

```
header some header
```

```
footer some footer
```

```
title My title
```

```
[Prototype design] lasts 13 days
```

```
legend
```

```
The legend
```

```
end legend
```

```
caption This is caption
```

```
@endgantt
```

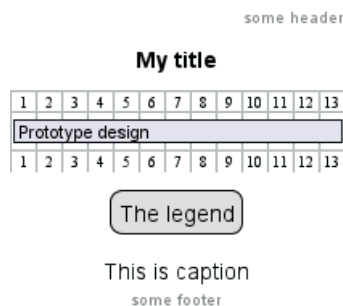

(Voir aussi : *Commandes communes*)

16.33 Suppression de l'encadré de pied de page (exemple pour toutes les échelles)

Vous pouvez utiliser les mots-clés `hide footbox` pour supprimer les boîtes de pied du diagramme de gantt (comme pour le diagramme de séquence).

Exemples sur :

- échelle quotidienne (*sans début de projet*)

```
@startgantt
```

```
hide footbox
```



```
title Foot Box removed

[Prototype design] lasts 15 days
[Test prototype] lasts 10 days
@endgantt
```

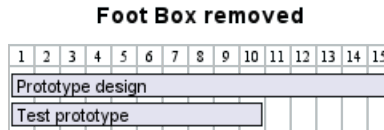

- échelle journalière

```
@startgantt
Language fr
Project starts the 20th of september 2017
[Prototype design] as [TASK1] lasts 13 days
[TASK1] is colored in Lavender/LightBlue
```

```
hide footbox
@endgantt
```

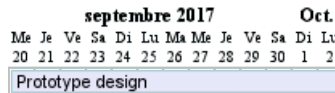

- échelle hebdomadaire

```
@startgantt
hide footbox
Language fr

printscale weekly
saturday are closed
sunday are closed

Project starts the 1st of january 2021
[Prototype design end] as [TASK1] lasts 19 days
[TASK1] is colored in Lavender/LightBlue
[Testing] lasts 14 days
[TASK1]->[Testing]
```

```
2021-01-18 to 2021-01-22 are named [End's committee]
2021-01-18 to 2021-01-22 are colored in salmon
@endgantt
```

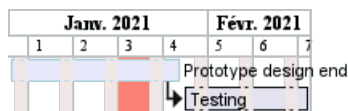

- échelle mensuelle

```
@startgantt

hide footbox

Language fr
projectscale monthly
Project starts the 20th of september 2020
[Prototype design] as [TASK1] lasts 130 days
[TASK1] is colored in Lavender/LightBlue
```

```
[Testing] lasts 20 days
[TASK1]->[Testing]
```

```
2021-01-18 to 2021-01-22 are named [End's committee]
2021-01-18 to 2021-01-22 are colored in salmon
@endgantt
```

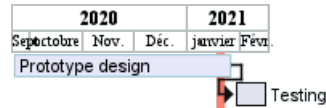

- échelle trimestrielle

```
@startgantt
```

```
hide footbox
```

```
Language fr
projectscale quarterly
Project starts the 1st of october 2020
[Prototype design] as [TASK1] lasts 700 days
[TASK1] is colored in Lavender/LightBlue
[Testing] lasts 200 days
[TASK1]->[Testing]
```

```
2021-01-18 to 2021-03-22 are colored in salmon
@endgantt
```

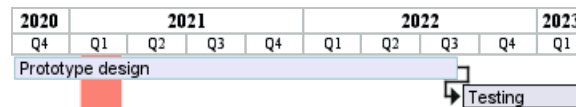

- échelle annuelle

```
@startgantt
```

```
hide footbox
```

```
Language fr
projectscale yearly
Project starts the 1st of october 2020
[Prototype design] as [TASK1] lasts 700 days
[TASK1] is colored in Lavender/LightBlue
[Testing] lasts 200 days
[TASK1]->[Testing]
```

```
2021-01-18 to 2021-03-22 are colored in salmon
@endgantt
```

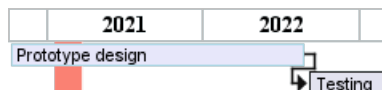

16.34 Langue du calendrier

Vous pouvez choisir la langue du calendrier Gantt, avec la commande `language <xx>` où `<xx>` est le code ISO 639 de la langue.

16.34.1 Anglais (*en*, par défaut)

```
@startgantt
```



saturday are closed
sunday are closed

Project starts 2021-01-01
[Prototype design end] as [TASK1] lasts 19 days
[TASK1] is colored in Lavender/LightBlue
[Testing] lasts 14 days
[TASK1]->[Testing]

2021-01-18 to 2021-01-22 are colored in salmon
@endgantt

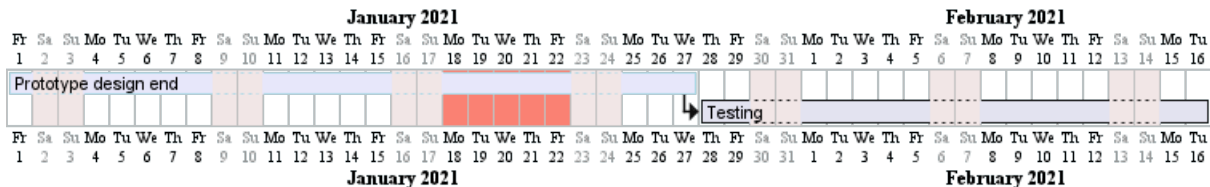

16.34.2 Français (fr)

@startgantt
language fr
saturday are closed
sunday are closed

Project starts 2021-01-01
[Prototype design end] as [TASK1] lasts 19 days
[TASK1] is colored in Lavender/LightBlue
[Testing] lasts 14 days
[TASK1]->[Testing]

2021-01-18 to 2021-01-22 are colored in salmon
@endgantt

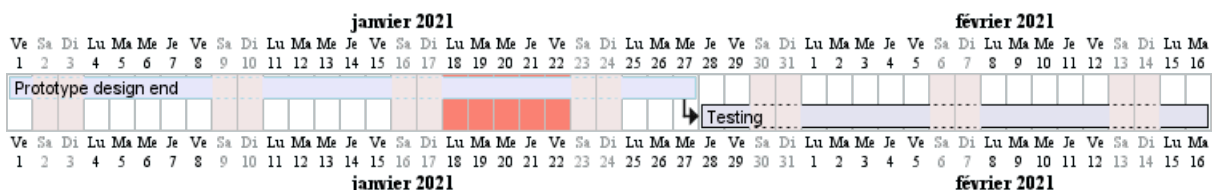

16.34.3 Allemand (de)

@startgantt
language de
saturday are closed
sunday are closed

Project starts 2021-01-01
[Prototype design end] as [TASK1] lasts 19 days
[TASK1] is colored in Lavender/LightBlue
[Testing] lasts 14 days
[TASK1]->[Testing]

2021-01-18 to 2021-01-22 are colored in salmon
@endgantt



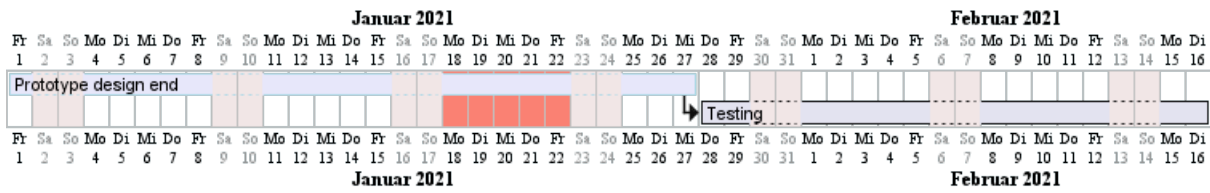

16.34.4 Japonais (ja)

```
@startgantt
language ja
saturday are closed
sunday are closed
```

```
Project starts 2021-01-01
[Prototype design end] as [TASK1] lasts 19 days
[TASK1] is colored in Lavender/LightBlue
[Testing] lasts 14 days
[TASK1]->[Testing]
```

```
2021-01-18 to 2021-01-22 are colored in salmon
@endgantt
```

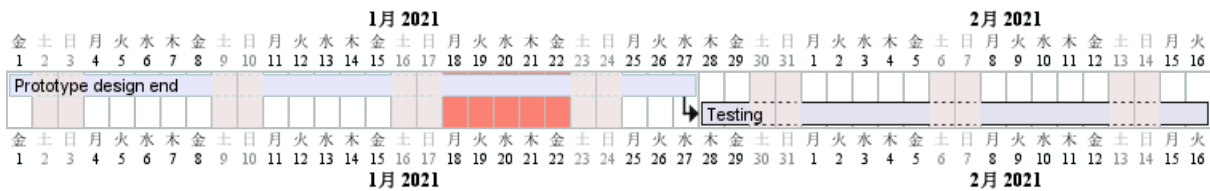

16.34.5 Chinois (zh)

```
@startgantt
language zh
saturday are closed
sunday are closed
```

```
Project starts 2021-01-01
[Prototype design end] as [TASK1] lasts 19 days
[TASK1] is colored in Lavender/LightBlue
[Testing] lasts 14 days
[TASK1]->[Testing]
```

```
2021-01-18 to 2021-01-22 are colored in salmon
@endgantt
```

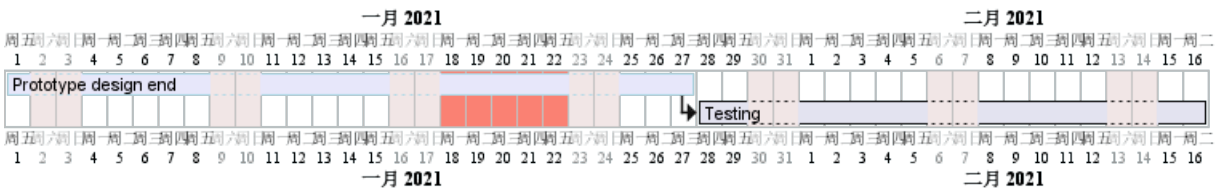

16.34.6 Coréen (ko)

```
@startgantt
language ko
saturday are closed
sunday are closed
```

```

Project starts 2021-01-01
[Prototype design end] as [TASK1] lasts 19 days
[TASK1] is colored in Lavender/LightBlue
[Testing] lasts 14 days
[TASK1]->[Testing]

```

```

2021-01-18 to 2021-01-22 are colored in salmon
@endgantt

```

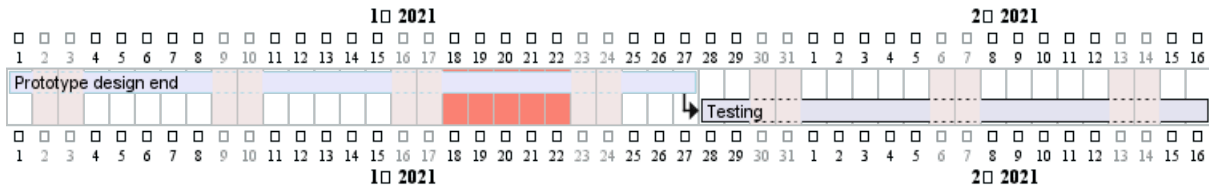

16.35 Supprimer des tâches ou des jalons

Vous pouvez marquer certaines tâches ou certains jalons comme `deleted` au lieu de normalement terminés pour distinguer les tâches qui ont pu être éventuellement écartées, reportées ou autres.

```

@startgantt
[Prototype design] lasts 1 weeks
then [Prototype completed] lasts 4 days
[End Prototype completed] happens at [Prototype completed]'s end
then [Test prototype] lasts 5 days
[End Test prototype] happens at [Test prototype]'s end

[Prototype completed] is deleted
[End Prototype completed] is deleted
@endgantt

```

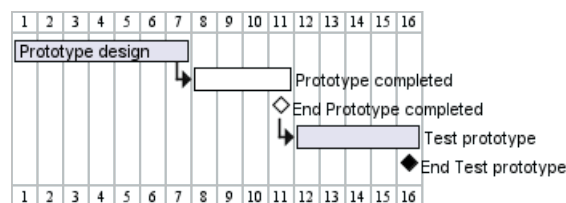

[Réf. QA-9129]

16.36 Start a project, a task or a milestone a number of days before or after today

You can start a project, a task or a milestone a number of days before or after today, using the builtin functions `%now` and `%date`:

```

@startgantt
title Today is %date("YYYY-MM-dd")
!$now = %now()
!$past = %date("YYYY-MM-dd", $now - 14*24*3600)
Project starts $past
today is colored in pink
[foo] lasts 10 days
[bar] lasts 5 days and starts %date("YYYY-MM-dd", $now + 4*24*3600)
[Tomorrow] happens %date("YYYY-MM-dd", $now + 1*24*3600)
@endgantt

```



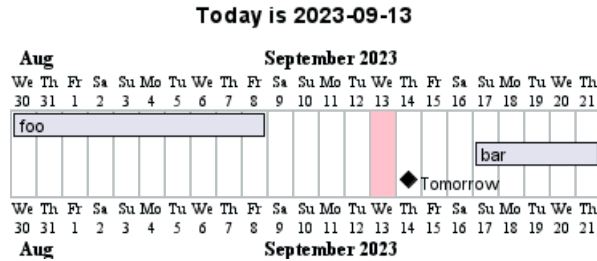

[Ref. QA-16285]

16.37 Change Label position

16.37.1 The labels are near elements (*by default*)

```
@startgantt
[Task1] lasts 1 days
then [Task2_long_long_long] as [T2] lasts 2 days
-- Phase Two --
then [Task3] as [T3] lasts 2 days
[Task4] as [T4] lasts 1 day
[Task5] as [T5] lasts 2 days
[T2] -> [T4]
[T2] -> [T5]
[Task6_long_long_long] as [T6] lasts 4 days
[T3] -> [T6]
[T5] -> [T6]
[End] happens 1 day after [T6]'s end
@endgantt
```

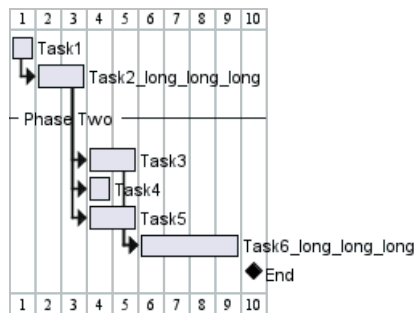

To change the label position, you can use the command `label`:

16.37.2 Label on first column

- Left aligned

```
@startgantt
Label on first column and left aligned
[Task1] lasts 1 days
then [Task2_long_long_long] as [T2] lasts 2 days
-- Phase Two --
then [Task3] as [T3] lasts 2 days
[Task4] as [T4] lasts 1 day
[Task5] as [T5] lasts 2 days
[T2] -> [T4]
[T2] -> [T5]
[Task6_long_long_long] as [T6] lasts 4 days
[T3] -> [T6]
[T5] -> [T6]
[End] happens 1 day after [T6]'s end
```



```
@endgantt
```

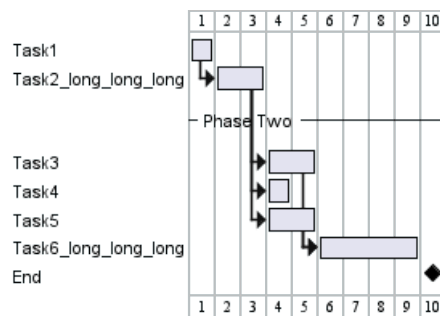

- Right aligned

```
@startgantt
```

```
Label on first column and right aligned
```

```
[Task1] lasts 1 days
then [Task2_long_long_long] as [T2] lasts 2 days
-- Phase Two --
then [Task3] as [T3] lasts 2 days
[Task4] as [T4] lasts 1 day
[Task5] as [T5] lasts 2 days
[T2] -> [T4]
[T2] -> [T5]
[Task6_long_long_long] as [T6] lasts 4 days
[T3] -> [T6]
[T5] -> [T6]
[End] happens 1 day after [T6]'s end
@endgantt
```

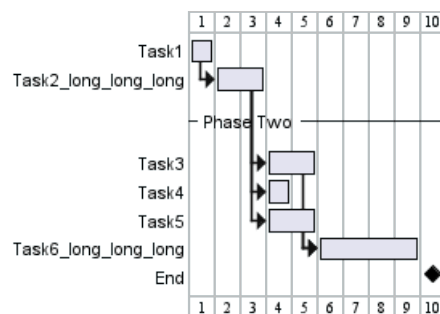

16.37.3 Label on last column

- Left aligned

```
@startgantt
```

```
Label on last column and left aligned
```

```
[Task1] lasts 1 days
then [Task2_long_long_long] as [T2] lasts 2 days
-- Phase Two --
then [Task3] as [T3] lasts 2 days
[Task4] as [T4] lasts 1 day
[Task5] as [T5] lasts 2 days
[T2] -> [T4]
[T2] -> [T5]
[Task6_long_long_long] as [T6] lasts 4 days
[T3] -> [T6]
[T5] -> [T6]
[End] happens 1 day after [T6]'s end
@endgantt
```



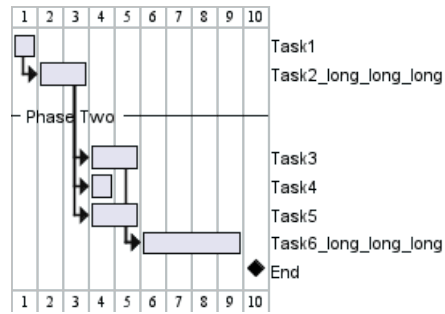

- Right aligned

```

@startgantt
Label on last column and right aligned
[Task1] lasts 1 days
then [Task2_long_long_long] as [T2] lasts 2 days
-- Phase Two --
then [Task3] as [T3] lasts 2 days
[Task4] as [T4] lasts 1 day
[Task5] as [T5] lasts 2 days
[T2] -> [T4]
[T2] -> [T5]
[Task6_long_long_long] as [T6] lasts 4 days
[T3] -> [T6]
[T5] -> [T6]
[End] happens 1 day after [T6]'s end
@endgantt

```

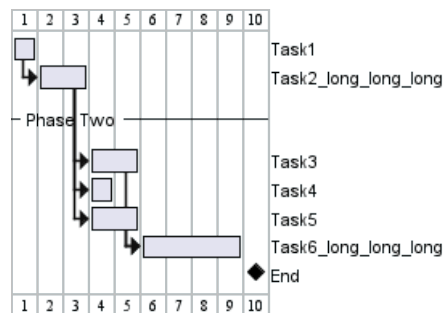

[Ref. QA-12433]



17 MindMap

Les cartes MindMap sont encore en beta : la syntaxe peut être amenée à évoluer.

17.1 Syntaxe OrgMode

La syntaxe OrgMode est supportée.

```
@startmindmap
* Debian
** Ubuntu
*** Linux Mint
*** Kubuntu
*** Lubuntu
*** KDE Neon
** LMDE
** SolydXK
** SteamOS
** Raspbian with a very long name
*** <s>Raspmbc</s> => OSMC
*** <s>Raspyfi</s> => Volumio
@endmindmap
```

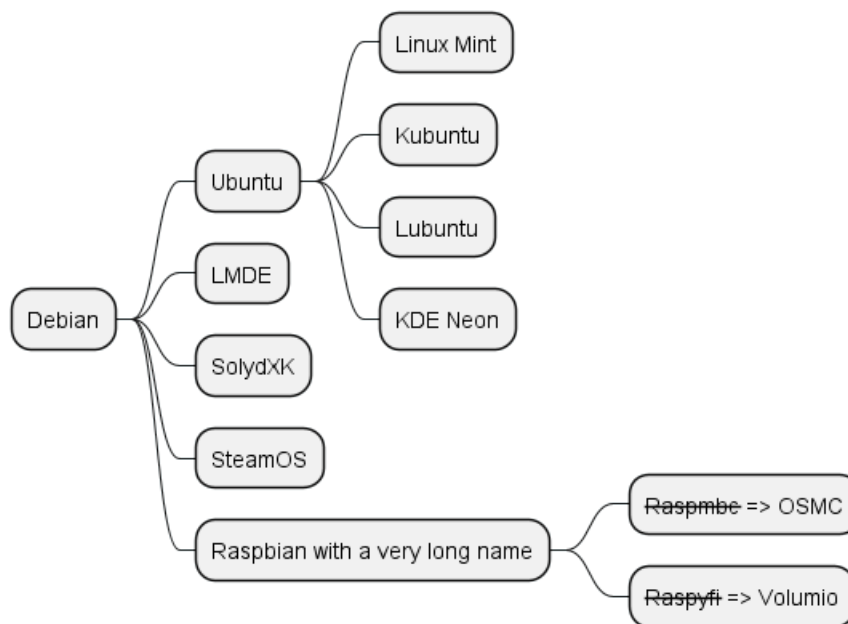

17.2 Syntaxe Markdown

La syntaxe Markdown est supportée.

```
@startmindmap
* root node
* some first level node
* second level node
* another second level node
* another first level node
@endmindmap
```



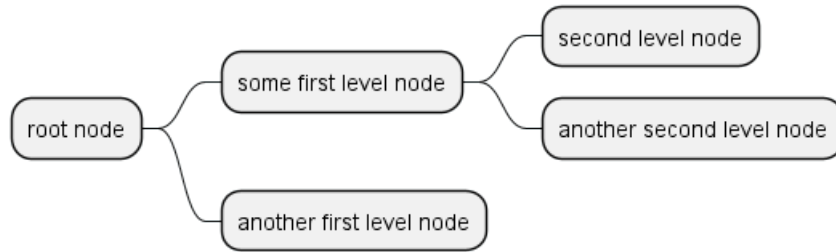

17.3 Notation arithmétique [+ , -]

Vous pouvez utiliser la notation suivante pour orienter votre diagramme.

```

@startmindmap
+ OS
++ Ubuntu
+++ Linux Mint
+++ Kubuntu
+++ Lubuntu
+++ KDE Neon
++ LMDE
++ SolydXK
++ SteamOS
++ Raspbian
-- Windows 95
-- Windows 98
-- Windows NT
--- Windows 8
--- Windows 10
@endmindmap
  
```

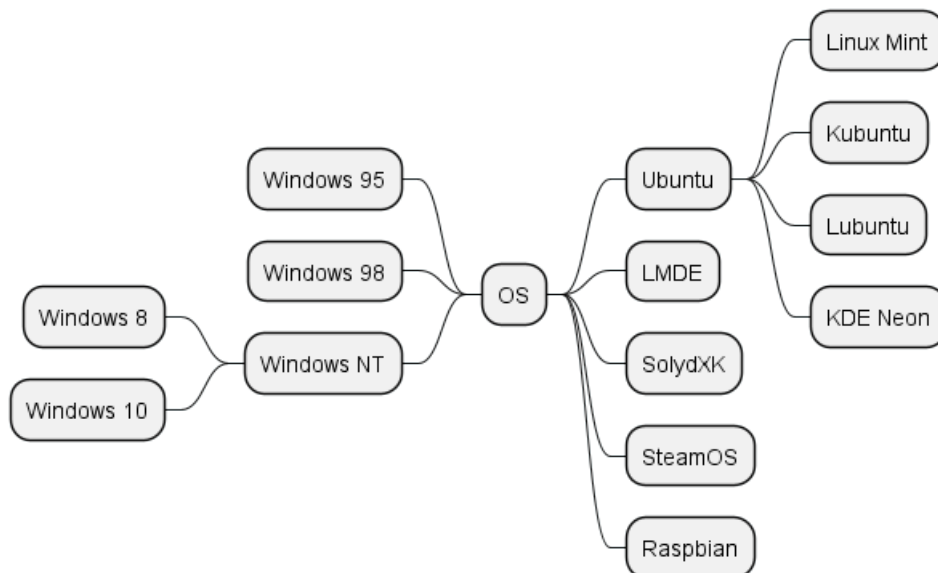

17.4 Multilignes

Le contenu multiligne des boîtes commence avec : et finisse avec ;.

```

@startmindmap
* Class Templates
  
```



```

**:Example 1
<code>
template <typename T>
class cname{
void f1()<U+003B>
...
}
</code>
;
**:Example 2
<code>
other template <typename T>
class cname{
...
</code>
;
@endmindmap

```

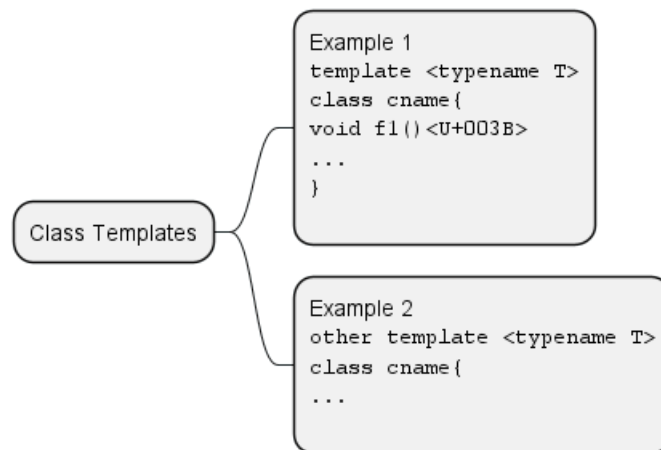

(Penser à échapper le ;, s'il apparait en fin de ligne intermédiaire dans le contenu, par exemple par son correspondant unicode <U+003B>)

17.5 Multiroot Mindmap

You can create multiroot mindmap, as:

```

@startmindmap
* Root 1
** Foo
** Bar
* Root 2
** Lorem
** Ipsum
@endmindmap

```



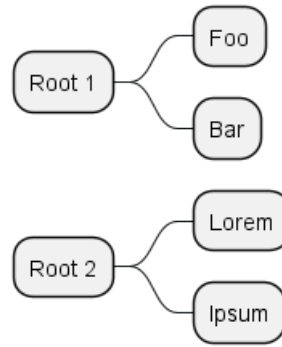

[Ref. QH-773]

17.6 Couleurs

Il est possible de changer la couleur des nœuds.

17.6.1 Avec couleur en ligne

- OrgMode syntaxe mindmap

```

@startmindmap
* [#Orange] Colors
** [#lightgreen] Green
** [#FFBCC] Rose
** [#lightblue] Blue
@endmindmap

```

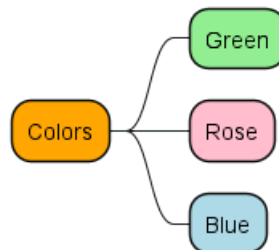

- Syntaxe de la notation arithmétique mindmap

```

@startmindmap
+ [#Orange] Colors
++ [#lightgreen] Green
++ [#FFBCC] Rose
-- [#lightblue] Blue
@endmindmap

```

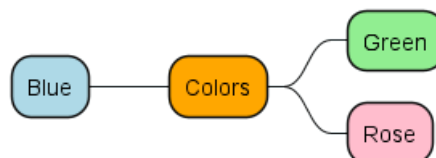

- Carte heuristique de la syntaxe Markdown

```

@startmindmap
* [#Orange] root node

```



```

*[#lightgreen] some first level node
*[#FFBBCC] second level node
*[#lightblue] another second level node
*[#lightgreen] another first level node
@endmindmap

```

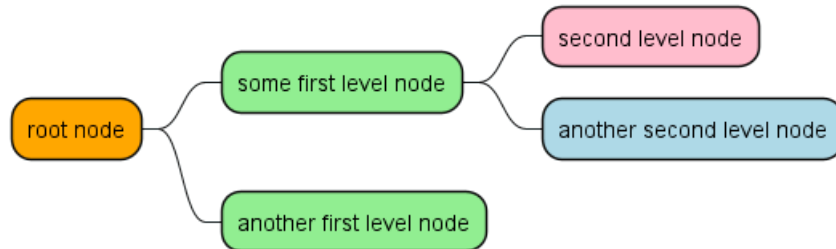

17.6.2 Avec couleur de style

- Carte mentale de syntaxe OrgMode

```

@startmindmap
<style>
mindmapDiagram {
  .green {
    BackgroundColor lightgreen
  }
  .rose {
    BackgroundColor #FFBBCC
  }
  .your_style_name {
    BackgroundColor lightblue
  }
}
</style>
* Colors
** Green <<green>>
** Rose <<rose>>
** Blue <<your_style_name>>
@endmindmap

```

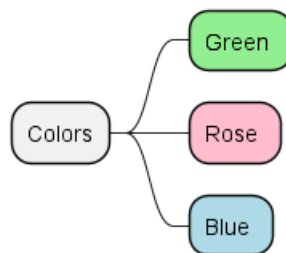

- Cartographie de la syntaxe de la notation arithmétique

```

@startmindmap
<style>
mindmapDiagram {
  .green {
    BackgroundColor lightgreen
  }
  .rose {

```



```

    BackgroundColor #FFBBCC
  }
  .your_style_name {
    BackgroundColor lightblue
  }
}
</style>
+ Colors
++ Green <<green>>
++ Rose <<rose>>
-- Blue <<your_style_name>>
@endmindmap

```

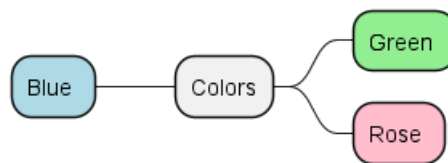

- Carte heuristique de la syntaxe Markdown

```

@startmindmap
<style>
mindmapDiagram {
  .green {
    BackgroundColor lightgreen
  }
  .rose {
    BackgroundColor #FFBBCC
  }
  .your_style_name {
    BackgroundColor lightblue
  }
}
</style>
* root node
* some first level node <<green>>
  * second level node <<rose>>
  * another second level node <<your_style_name>>
* another first level node <<green>>
@endmindmap

```

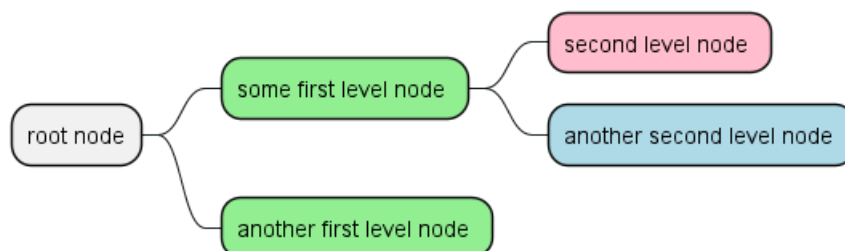

[Ref. GA-920]

17.7 Masquer les bordures []

Vous pouvez enlever les contours des boîtes en utilisant le caractère tiret bas (`_`), comme pour les diagrammes de type WBS.



```

@startmindmap
* root node
** some first level node
***_ second level node
***_ another second level node
***_ foo
***_ bar
***_ foobar
** another first level node
@endmindmap

```

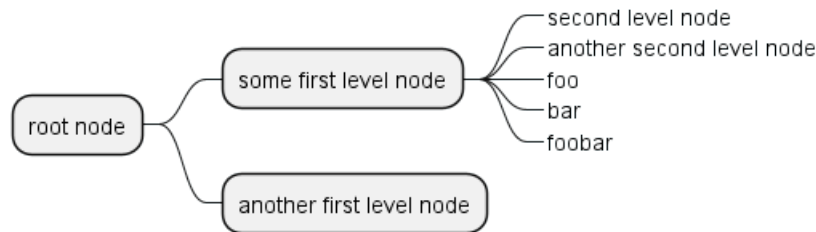

```

@startmindmap
*_ root node
**_ some first level node
***_ second level node
***_ another second level node
***_ foo
***_ bar
***_ foobar
**_ another first level node
@endmindmap

```

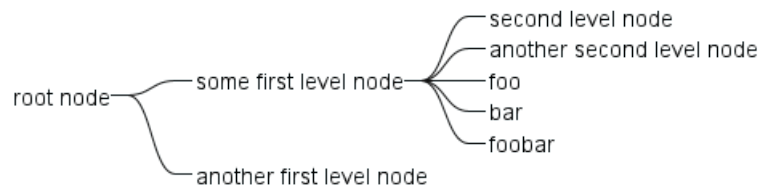

```

@startmindmap
+ root node
++ some first level node
++_ second level node
++_ another second level node
++_ foo
++_ bar
++_ foobar
++_ another first level node
-- some first right level node
--_ another first right level node
@endmindmap

```

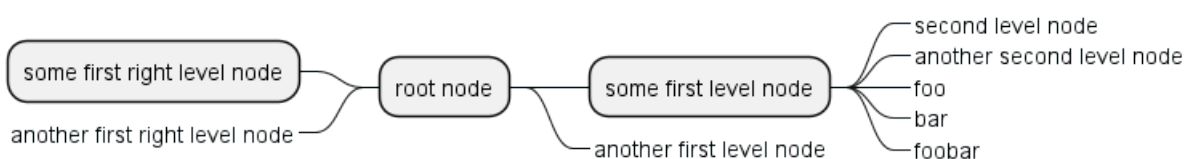

17.8 Diagramme multi-directionnel

Il est possible d'utiliser les deux côtés du diagramme.

```
@startmindmap
* count
** 100
*** 101
*** 102
** 200

left side
** A
*** AA
*** AB
** B
@endmindmap
```

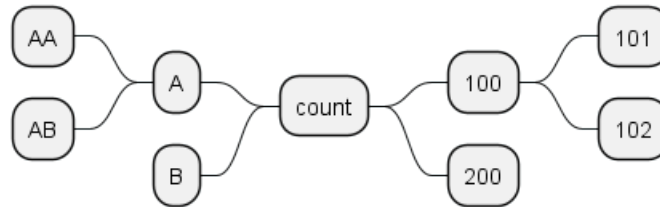

17.9 Exemple complet

```
@startmindmap
caption figure 1
title My super title

* <&flag>Debian
** <&globe>Ubuntu
*** Linux Mint
*** Kubuntu
*** Lubuntu
*** KDE Neon
** <&graph>LMDE
** <&pulse>SolydXK
** <&people>SteamOS
** <&star>Raspbian with a very long name
*** <s>Raspmbc</s> => OSMC
*** <s>Raspyfi</s> => Volumio

header
My super header
endheader

center footer My super footer

legend right
Short
legend
endlegend
@endmindmap
```



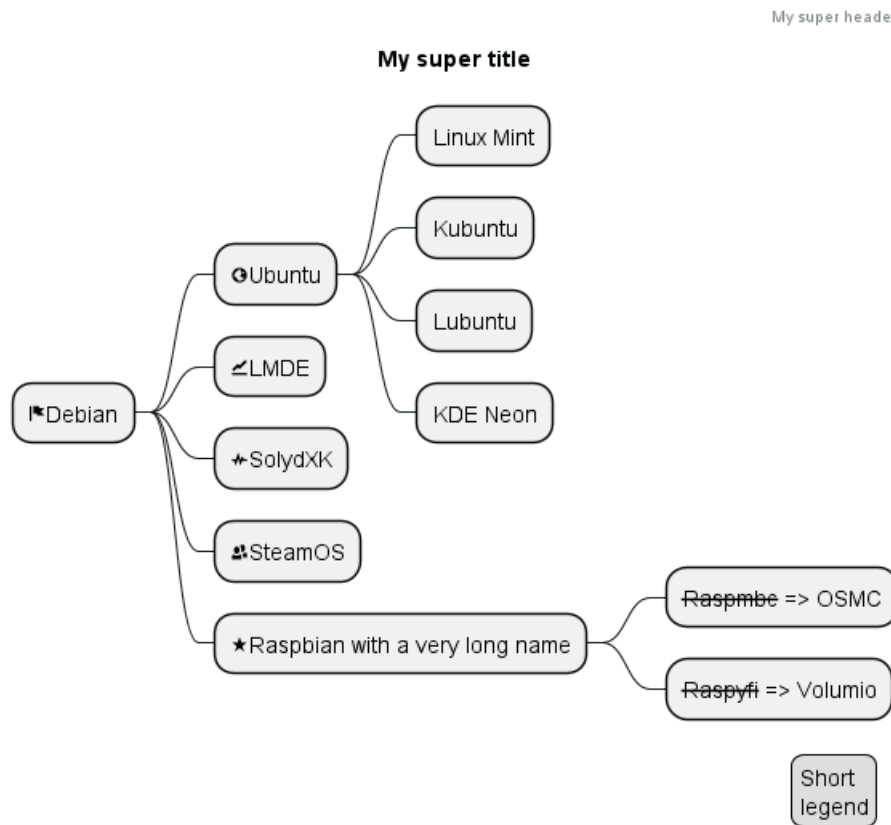

figure 1
My super footer

17.10 Changement de style

17.10.1 nœud, profondeur

```

@startmindmap
<style>
mindmapDiagram {
  node {
    BackgroundColor lightGreen
  }
  :depth(1) {
    BackGroundColor white
  }
}
</style>
* Linux
** NixOS
** Debian
*** Ubuntu
**** Linux Mint
**** Kubuntu
**** Lubuntu
**** KDE Neon
@endmindmap
  
```



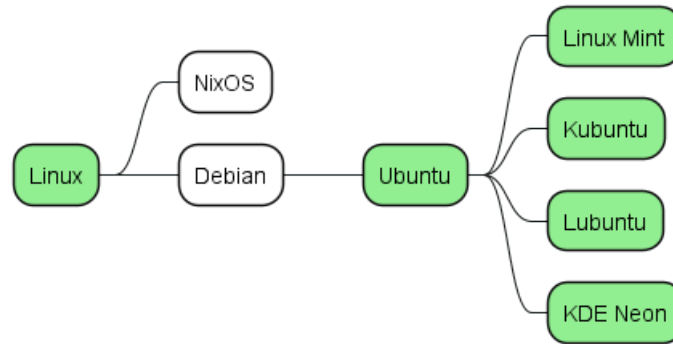

17.10.2 sans boîte

```

@startmindmap
<style>
mindmapDiagram {
  node {
    BackgroundColor lightGreen
  }
  boxless {
    FontColor darkgreen
  }
}
</style>
* Linux
** NixOS
** Debian
***_ Ubuntu
**** Linux Mint
**** Kubuntu
**** Lubuntu
**** KDE Neon
@endmindmap
  
```

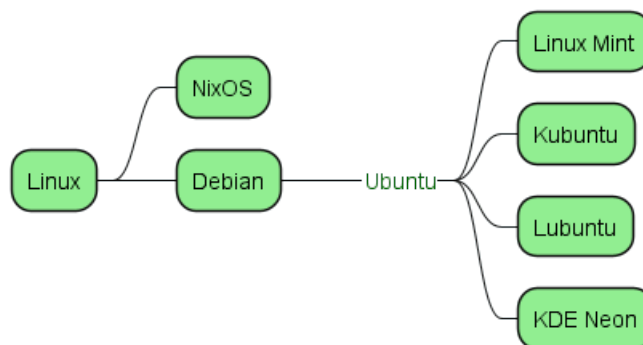

17.11 Word Wrap

Le paramètre `MaximumWidth` permet de contrôler le retour à ligne automatique. L'unité utilisée est le pixel

```
@startmindmap
```

```
<style>
```

```

node {
  Padding 12
  Margin 3
  HorizontalAlignment center
  LineColor blue
  LineThickness 3.0
  BackgroundColor gold
  RoundCorner 40
  MaximumWidth 100
}

rootNode {
 LineStyle 8.0;3.0
  LineColor red
  BackgroundColor white
  LineThickness 1.0
  RoundCorner 0
  Shadowing 0.0
}

leafNode {
  LineColor gold
  RoundCorner 0
  Padding 3
}

arrow {
  LineStyle 4
  LineThickness 0.5
  LineColor green
}
</style>

* Hi =)
** sometimes i have node in wich i want to write a long text
*** this results in really huge diagram
**** of course, i can explicit split with a\nnew line
**** but it could be cool if PlantUML was able to split long lines, maybe with an option

@endmindmap

```

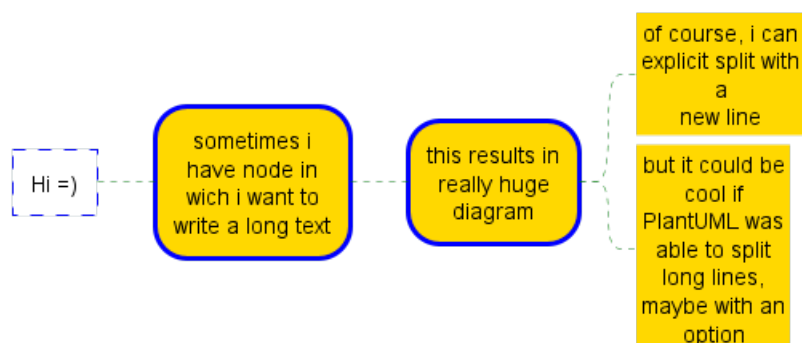

17.12 Creole on Mindmap diagram

You can use Creole or HTML Creole on Mindmap:

```
@startmindmap
```



```

* Creole on Mindmap
left side
**::=Creole
  This is bold
  This is italics
  This is "monospaced"
  This is stricken-out
  This is underlined
  This is wave-underlined
--test Unicode and icons--
  This is <U+221E> long
  This is a <&code> icon
  Use image : <img:http://plantuml.com/logo3.png>
;
**: <b>HTML Creole
  This is <b>bold</b>
  This is <i>italics</i>
  This is <font:monospaced>monospaced</font>
  This is <s>stroked</s>
  This is <u>underlined</u>
  This is <w>waved</w>
  This is <s:green>stroked</s>
  This is <u:red>underlined</u>
  This is <w:#0000FF>waved</w>
-- other examples --
  This is <color:blue>Blue</color>
  This is <back:orange>Orange background</back>
  This is <size:20>big</size>
;
right side
**::=Creole line
You can have horizontal line
----
Or double line
====
Or strong line
-----
Or dotted line
..My title..
Or dotted title
//and title... //
==Title==
Or double-line title
--Another title--
Or single-line title
Enjoy!;
**::=Creole list item
**test list 1**
* Bullet list
* Second item
** Sub item
*** Sub sub item
* Third item
----
**test list 2**
# Numbered list
# Second item
## Sub item

```



```
## Another sub item
# Third item
;
@endmindmap
```

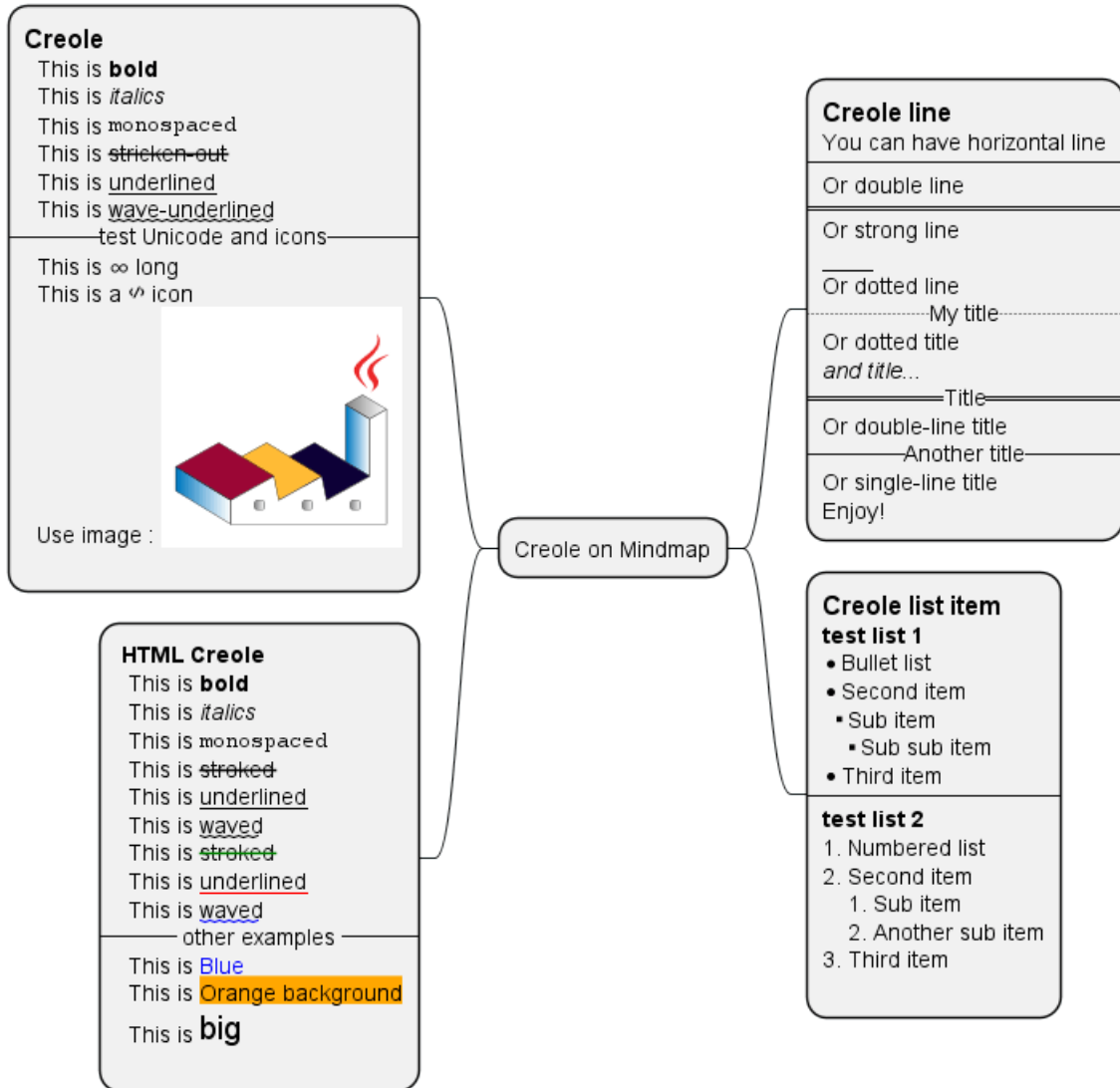

[Ref. QA-17838]



18 Work Breakdown Structure (WBS)

Les diagrammes de type *organigramme des tâches du projet (OTP)* ou *structure de découpage du projet (SDP)*, ou encore *Work Breakdown Structure (WBS)* (en anglais) sont encore en phase de test : leur syntaxe peut évoluer sans aucune garantie.

18.1 Syntaxe OrgMode

La syntaxe est compatible avec celle de OrgMode.

```
@startwbs
* Business Process Modelling WBS
** Launch the project
*** Complete Stakeholder Research
*** Initial Implementation Plan
** Design phase
*** Model of AsIs Processes Completed
**** Model of AsIs Processes Completed1
**** Model of AsIs Processes Completed2
*** Measure AsIs performance metrics
*** Identify Quick Wins
** Complete innovate phase
@endwbs
```

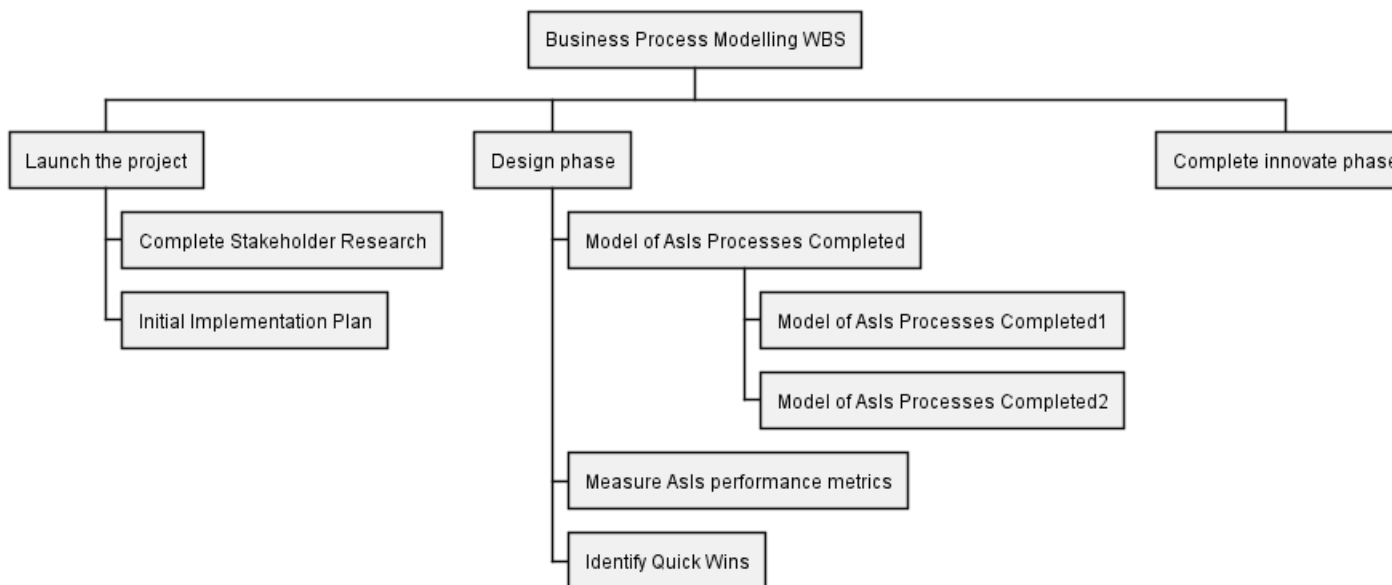

18.2 Changement de direction [\leftarrow , \rightarrow]

Vous pouvez changer de direction en utilisant :

- \leftarrow
- \rightarrow

```
@startwbs
* Business Process Modelling WBS
** Launch the project
*** Complete Stakeholder Research
*** Initial Implementation Plan
** Design phase
*** Model of AsIs Processes Completed
****< Model of AsIs Processes Completed1
```



```

****> Model of AsIs Processes Completed2
***< Measure AsIs performance metrics
***< Identify Quick Wins
@endwbs

```

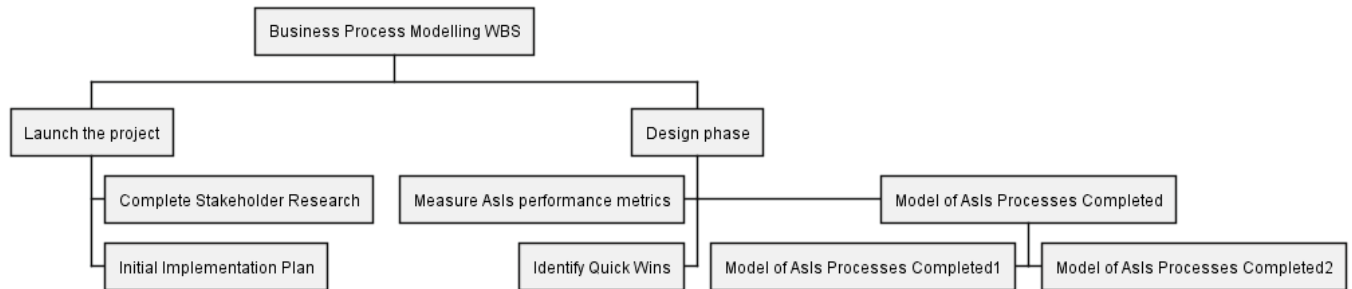

18.3 Notation arithmétique [+ , -]

Vous pouvez utiliser la notation suivante (avec des + ou des -) pour choisir le côté du diagramme.

```

@startwbs
+ New Job
++ Decide on Job Requirements
+++ Identity gaps
+++ Review JDs
++++ Sign-Up for courses
++++ Volunteer
++++ Reading
+- Checklist
+++- Responsibilities
+++- Location
++ CV Upload Done
+++ CV Updated
++++ Spelling & Grammar
++++ Check dates
---- Skills
+++ Recruitment sites chosen
@endwbs

```

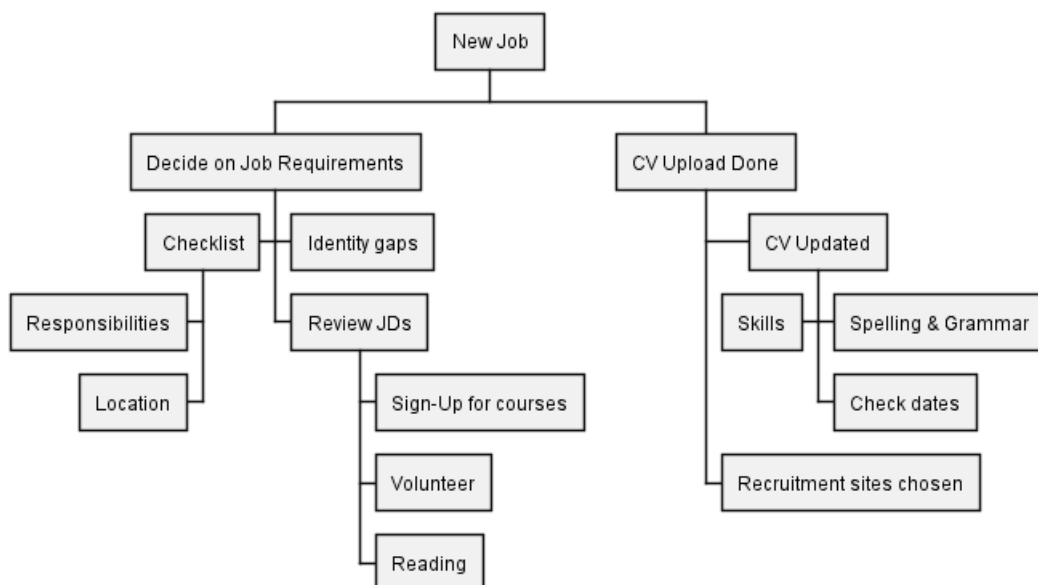

18.4 Multi-lignes

Vous pouvez utiliser : et ; pour obtenir une boîte multi-lignes, comme sur MindMap.

```
@startwbs
* <&flag> Debian
** <&globe> Ubuntu

***:Linux Mint
Open Source;

*** Kubuntu
*** ...
@endwbs
```

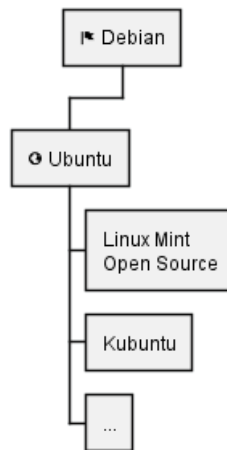

[Réf. QA-13945]

18.5 Masquer les bordures []

Vous pouvez enlever les contours des boîtes en utilisant le caractère tiret bas (`_`), comme pour les cartes MindMap.

```
@startwbs
+ Project
+ Part One
+ Task 1.1
- LeftTask 1.2
+ Task 1.3
+ Part Two
+ Task 2.1
+ Task 2.2
- _ Task 2.2.1 To the left boxless
- _ Task 2.2.2 To the Left boxless
+ _ Task 2.2.3 To the right boxless
@endwbs
```



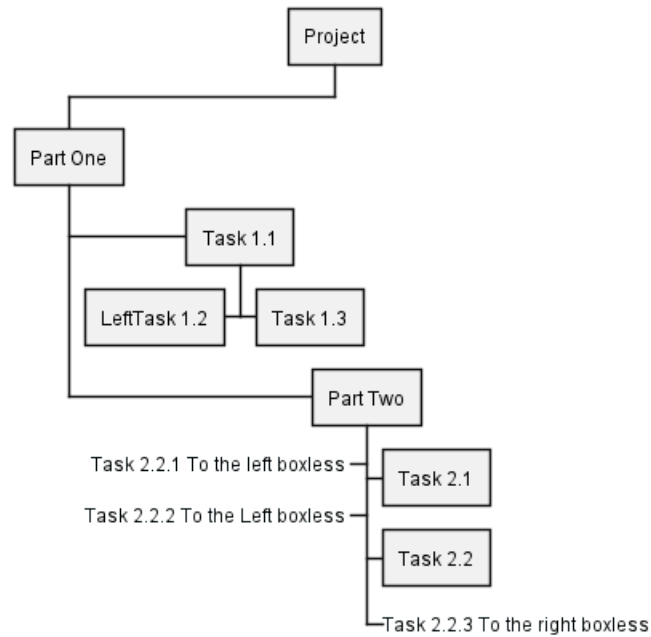

[Ref. QA-13297] [Ref. QA-13355]

18.6 Colors (with inline or style color)

It is possible to change node color:

- with inline color

```

@startwbs
* [#SkyBlue] this is the partner workpackage
** [#pink] this is my workpackage
** this is another workpackage
@endwbs
  
```

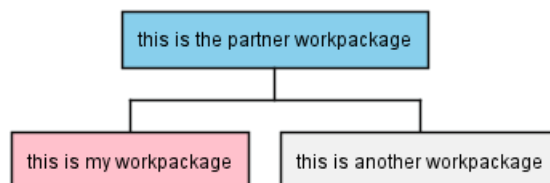

```

@startwbs
+ [#SkyBlue] this is the partner workpackage
++ [#pink] this is my workpackage
++ this is another workpackage
@endwbs
  
```

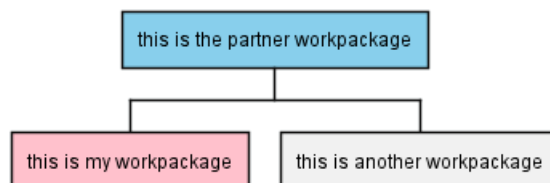

[Ref. QA-12374, only from v1.2020.20]

- with style color

```

@startwbs
<style>
  
```



```
wbsDiagram {
  .pink {
    BackgroundColor pink
  }
  .your_style_name {
    BackgroundColor SkyBlue
  }
}
</style>
* this is the partner workpackage <<your_style_name>>
** this is my workpackage <<pink>>
** this is another workpackage
@endwbs
```

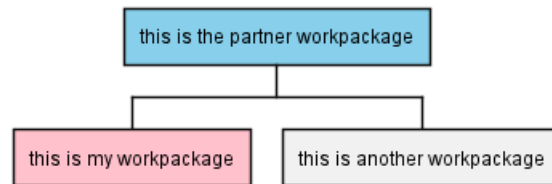

```
@startwbs
<style>
wbsDiagram {
  .pink {
    BackgroundColor pink
  }
  .your_style_name {
    BackgroundColor SkyBlue
  }
}
</style>
+ this is the partner workpackage <<your_style_name>>
++ this is my workpackage <<pink>>
++ this is another workpackage
@endwbs
```

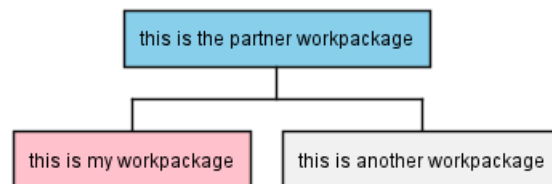

18.7 Using style

It is possible to change diagram style.

```
@startwbs
<style>
wbsDiagram {
  // all lines (meaning connector and borders, there are no other lines in WBS) are black by default
  LineColor black
  arrow {
    // note that connector are actually "arrow" even if they don't look like as arrow
    // This is to be consistent with other UML diagrams. Not 100% sure that it's a good idea
    // So now connector are green
    LineColor green
  }
}
</style>
```



```

:depth(0) {
  // will target root node
  BackgroundColor White
  RoundCorner 10
  LineColor red
  // Because we are targetting depth(0) for everything, border and connector for level 0 will be
}
arrow {
  :depth(2) {
    // Targetting only connector between Mexico-Chihuahua and USA-Texas
    LineColor blue
   LineStyle 4
    LineThickness .5
  }
}
node {
  :depth(2) {
   LineStyle 2
    LineThickness 2.5
  }
}
boxless {
  // will target boxless node with '_'
  FontColor darkgreen
}
}
</style>
* World
** America
*** Canada
*** Mexico
**** Chihuahua
*** USA
**** Texas
***< New York
** Europe
***_ England
***_ Germany
***_ Spain
@endwbs

```

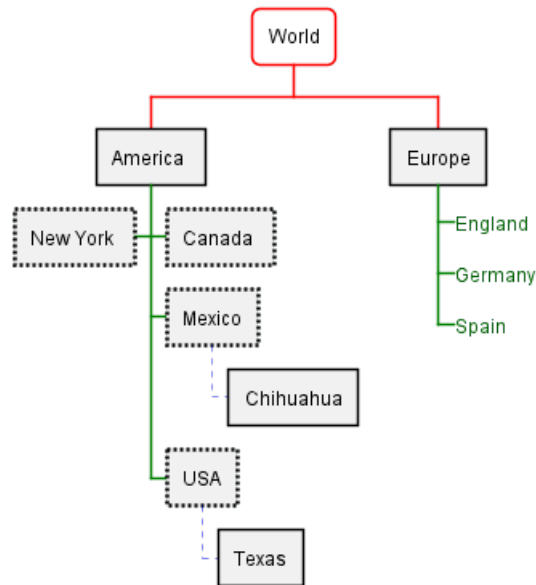

18.8 Word Wrap

Using `MaximumWidth` setting you can control automatic word wrap. Unit used is pixel.

```
@startwbs
```

```

<style>
node {
    Padding 12
    Margin 3
    HorizontalAlignment center
    LineColor blue
    LineThickness 3.0
    BackgroundColor gold
    RoundCorner 40
    MaximumWidth 100
}

rootNode {
    LineStyle 8.0;3.0
    LineColor red
    BackgroundColor white
    LineThickness 1.0
    RoundCorner 0
    Shadowing 0.0
}

leafNode {
    LineColor gold
    RoundCorner 0
    Padding 3
}

arrow {
    LineStyle 4
    LineThickness 0.5
    LineColor green
}

```



```
</style>
```

```
* Hi =)
```

```
** sometimes i have node in wich i want to write a long text
```

```
*** this results in really huge diagram
```

```
**** of course, i can explicit split with a\nnew line
```

```
**** but it could be cool if PlantUML was able to split long lines, maybe with an option who specify
```

```
@endwbs
```

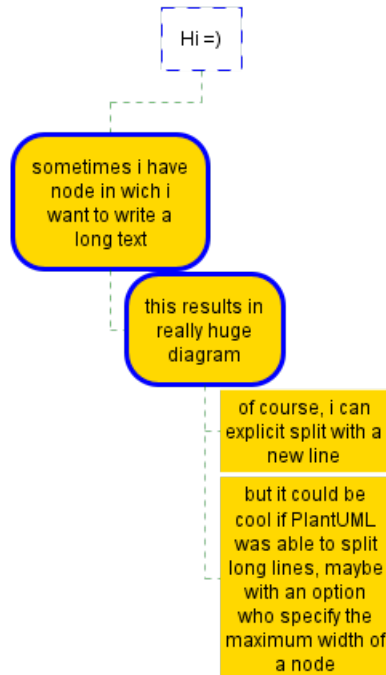

18.9 Add arrows between WBS elements

You can add arrows between WBS elements.

Using alias with as:

```
@startwbs
<style>
.foo {
  LineColor #00FF00;
}
</style>
* Test
** A topic
*** "common" as c1
*** "common2" as c2
** "Another topic" as t2
t2 -> c1 <<foo>>
t2 ..> c2 #blue
@endwbs
```



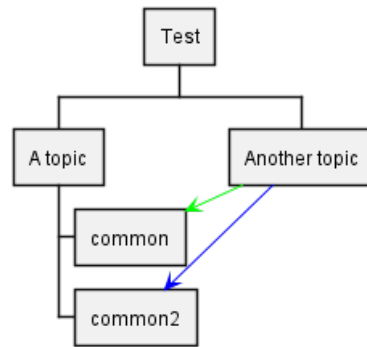

Using alias in parentheses:

```

@startwbs
* Test
**(b) A topic
**(c1) common
**(t2) Another topic
t2 --> c1
b -> t2 #blue
@endwbs
  
```

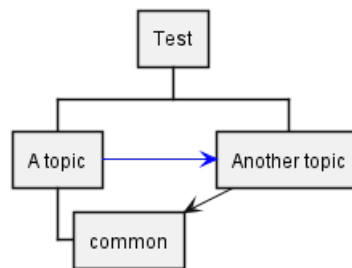

[Ref. QA-16251]

18.10 Creole on WBS diagram

You can use Creole or HTML Creole on WBS:

```

@startwbs
* Creole on WBS
**::=Creole
  This is bold
  This is italics
  This is "monospaced"
  This is stricken-out
  This is underlined
  This is wave-underlined
--test Unicode and icons--
  This is  long
  This is a code icon
  Use image : 

```



```

This is <s:green>stroked</s>
This is <u:red>underlined</u>
This is <w:#0000FF>waved</w>
-- other examples --
This is <color:blue>Blue</color>
This is <back:orange>Orange background</back>
This is <size:20>big</size>
;
**::=Creole line
You can have horizontal line
----
Or double line
=====
Or strong line
-----
Or dotted line
..My title..
Or dotted title
//and title... //
==Title==
Or double-line title
--Another title--
Or single-line title
Enjoy!;
**::=Creole list item
**test list 1**
* Bullet list
* Second item
** Sub item
*** Sub sub item
* Third item
----
**test list 2**
# Numbered list
# Second item
## Sub item
## Another sub item
# Third item
;
@endwbs

```

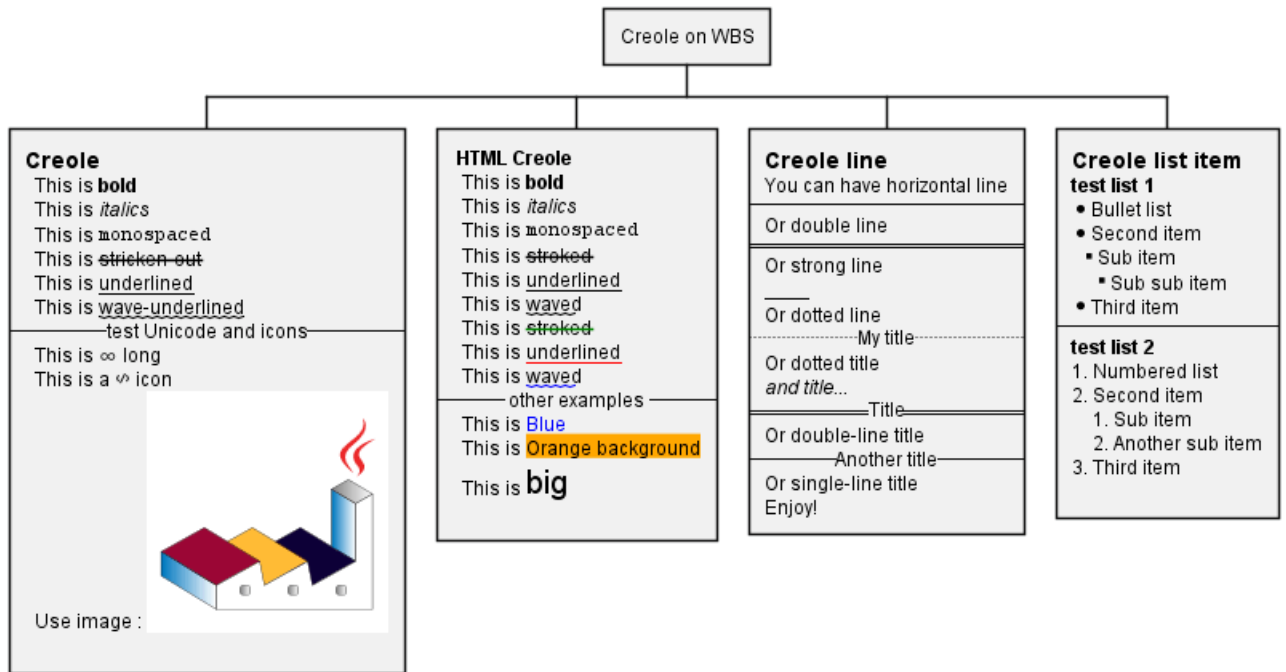

19 Mathématiques

Dans PlantUML, vous pouvez utiliser :

- les notations AsciiMath :

```
@startuml
:<math>int_0^1 f(x) dx</math>;
:<math>x^2+y_1+z_{12}^{34}</math>;
note right
Try also
<math>d/dx f(x)=lim_{(h->0)} (f(x+h)-f(x))/h</math>
<math>P(y|bb"x") or f(bb"x")+epsilon</math>
end note
@enduml
```

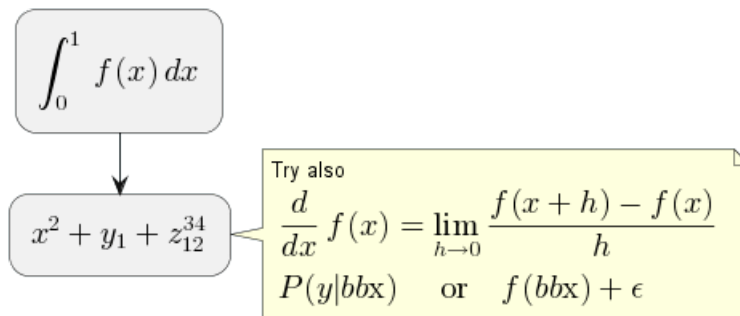

- les notations JLaTeXMath :

```
@startuml
:<latex>\int_0^1 f(x) dx</latex>;
:<latex>x^2+y_1+z_{12}^{34}</latex>;
note right
Try also
<latex>\dfrac{d}{dx} f(x)=\lim\limits_{h \to 0} \dfrac{f(x+h)-f(x)}{h}</latex>
<latex>P(y|\mathbf{x}) \mbox{ or } f(\mathbf{x})+\epsilon</latex>
end note
@enduml
```

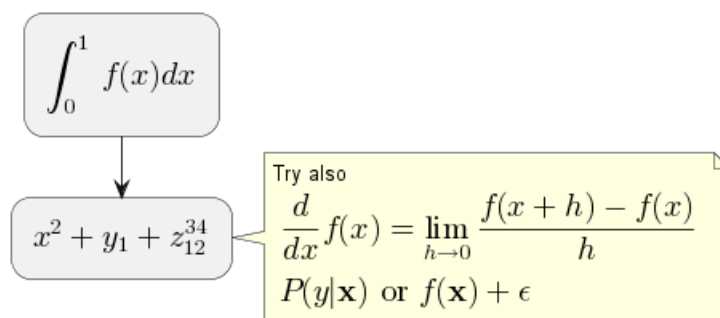

Autre exemple :

```
@startuml
Bob -> Alice : Peux-tu résoudre: <math>ax^2+bx+c=0</math>
Alice --> Bob: <math>x = (-b+-sqrt(b^2-4ac))/(2a)</math>
@enduml
```



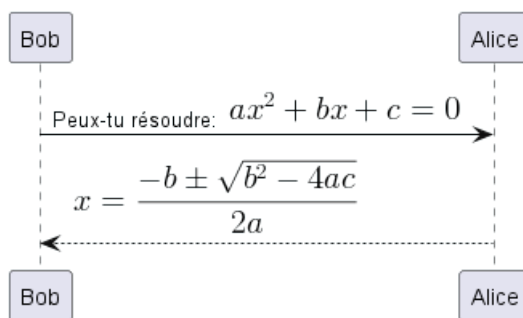

19.1 Diagramme indépendant

Il est possible d'utiliser `@startmath/@endmath` pour créer des formules AsciiMath.

```

@startmath
f(t)=(a_0)/2 + sum_(n=1)^oo a_n cos((npi t)/L)+sum_(n=1)^oo b_n sin((npi t)/L)
@endmath
  
```

$$f(t) = \frac{a_0}{2} + \sum_{n=1}^{\infty} a_n \cos\left(\frac{n\pi t}{L}\right) + \sum_{n=1}^{\infty} b_n \sin\left(\frac{n\pi t}{L}\right)$$

Ou bien utiliser `@startlatex/@endlatex` pour créer des formules JLaTeXMath.

```

@startlatex
\sum_{i=0}^{n-1} (a_i + b_i^2)
@endlatex
  
```

$$\sum_{i=0}^{n-1} (a_i + b_i^2)$$

19.2 Comment cela fonctionne ?

Pour dessiner ces formules, PlantUML utilise deux projets OpenSource:

- AsciiMath qui convertit la notation AsciiMath vers une expression LaTeX.
- JLatexMath qui dessine une formule mathématique écrite en LaTeX. JLaTeXMath est le meilleur projet Java pour dessiner du code LaTeX.

ASCIIMathTeXImg.js est suffisamment petit pour être intégré dans la distribution standard de PlantUML.

Comme JLatexMath est plus gros, vous devez le télécharger séparément, puis extraire les 4 fichiers (*batik-all-1.7.jar*, *jlatexmath-minimal-1.0.3.jar*, *jlm_cyrillic.jar* et *jlm_greek.jar*) dans le même répertoire que PlantUML.jar.



20 Entity Relationship Diagram

Based on the Information Engineering notation.

This is an extension to the existing Class Diagram. This extension adds:

- Additional relations for the Information Engineering notation.
- An **entity** alias that maps to the class diagram **class**.
- An additional visibility modifier ***** to identify mandatory attributes.

Otherwise, the syntax for drawing diagrams is the same as for class diagrams. All other features of class diagrams are also supported.

20.1 Information Engineering Relations

Type	Symbol
Zero or One	o--
Exactly One	--
Zero or Many	}o--
One or Many	} --

Examples:

```
@startuml
Entity01 }|..|| Entity02
Entity03 }o..o| Entity04
Entity05 ||--o{ Entity06
Entity07 |o--|| Entity08
@enduml
```

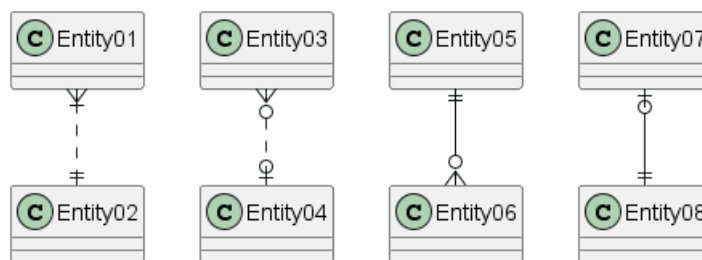

20.2 Entities

```
@startuml
entity Entity01 {
  * identifying_attribute
  --
  * mandatory_attribute
  optional_attribute
}
@enduml
```

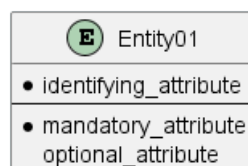

Again, this is the normal class diagram syntax (aside from use of **entity** instead of **class**). Anything that you can do in a class diagram can be done here.



The * visibility modifier can be used to identify mandatory attributes. A space can be used after the modifier character to avoid conflicts with the creole bold:

```
@startuml
entity Entity01 {
  optional attribute
  **optional bold attribute**
  * **mandatory bold attribute**
}
@enduml
```

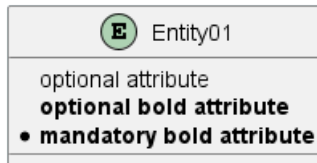

20.3 Complete Example

```
@startuml

' hide the spot
' hide circle

' avoid problems with angled crows feet
skinparam linetype ortho

entity "Entity01" as e01 {
  *e1_id : number <<generated>>
  --
  *name : text
  description : text
}

entity "Entity02" as e02 {
  *e2_id : number <<generated>>
  --
  *e1_id : number <<FK>>
  other_details : text
}

entity "Entity03" as e03 {
  *e3_id : number <<generated>>
  --
  e1_id : number <<FK>>
  other_details : text
}

entity "Entity04" as e04 {
  *e4_id : number <<generated>>
  --
  e1_id : number <<FK>>
  other_details : text
}

e01 ||..o{ e02
e01 |o..o{ e03
e01 |o..o{ e04
```



@enduml

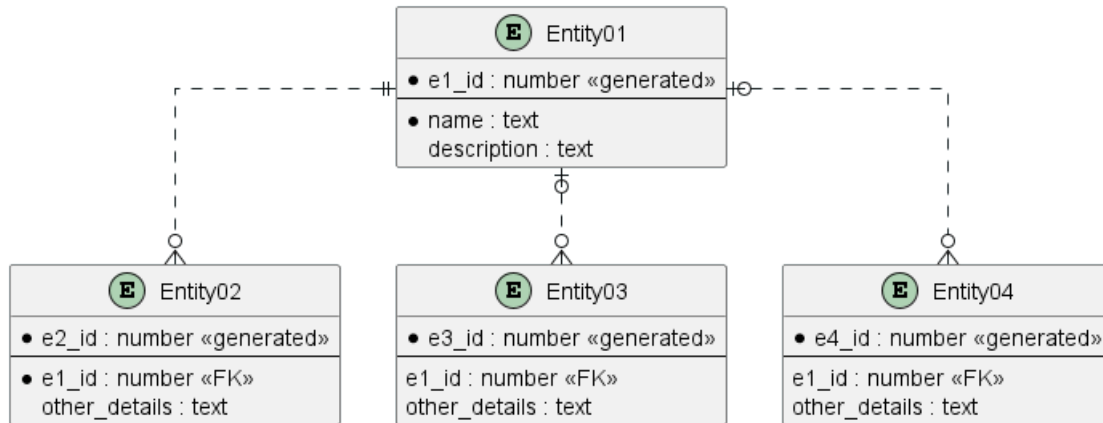

Currently the crows feet do not look very good when the relationship is drawn at an angle to the entity. This can be avoided by using the `linetype ortho` skinparam.

21 Commandes communes dans PlantUML

Découvrez les commandes fondamentales universellement applicables à tous les types de diagrammes dans PlantUML. Ces commandes vous permettent d'injecter de la polyvalence et des détails personnalisés dans vos diagrammes. Ci-dessous, nous répartissons ces commandes communes en trois catégories principales :

21.0.1 Global Elements

- **Comments** : Ajoutez des remarques ou des notes explicatives dans le script de votre diagramme pour transmettre des informations supplémentaires ou pour laisser des rappels en vue de modifications ultérieures.
- **Notes** : Incorporez des informations supplémentaires directement dans votre diagramme pour faciliter la compréhension ou pour mettre en évidence des aspects importants.
- **Size Control (Contrôle de la taille)** : Ajustez les dimensions des différents éléments en fonction de vos préférences, afin d'obtenir un diagramme équilibré et bien proportionné.
- **Titre et légendes** : Définissez un titre approprié et ajoutez des légendes pour clarifier le contexte ou pour annoter des parties spécifiques de votre diagramme.

21.0.2 Description de la syntaxe créole

Exploitez la puissance de la syntaxe créole pour formater davantage le contenu de n'importe quel élément de votre diagramme. Ce style de balisage wiki permet :

- **Formatage du texte** : Personnalisez l'apparence de votre texte avec différents styles et alignements.
- **Listes** : Créez des listes ordonnées ou non ordonnées pour présenter les informations de manière claire.
- **Liens** : Intégrez des hyperliens pour faciliter la navigation rapide vers les ressources pertinentes.

21.0.3 Commande de contrôle du style

Contrôlez entièrement le style de présentation de vos éléments de diagramme à l'aide de la commande `style`. Utilisez-la pour :

- **Définir des styles** : Définir des styles uniformes pour les éléments afin de maintenir un thème visuel cohérent.
- **Personnaliser les couleurs** : Choisir des couleurs spécifiques pour divers éléments afin d'améliorer l'attrait visuel et de créer des classifications distinctes.

Explorez ces commandes pour créer des diagrammes à la fois fonctionnels et esthétiques, en adaptant chaque élément à vos spécifications exactes.

21.1 Comments

21.1.1 Simple comment

Everything that starts with `simple quote ' is a comment.`

```
@startuml
'Line comments use a single apostrophe
@enduml
```

21.1.2 Block comment

Block comment use C-style comments except that instead of `*` you use an apostrophe `'`, then you can also put comments on several lines using `/'` to start and `/'` to end.



```
@startuml
/'
many lines comments
here
'/
@enduml
```

[Ref. QA-1353]

Then you can also put block comment on the same line, as:

```
@startuml
/' case 1 '/ A -> B : AB-First step
           B -> C : BC-Second step
/' case 2 '/ D -> E : DE-Third step
@enduml
```

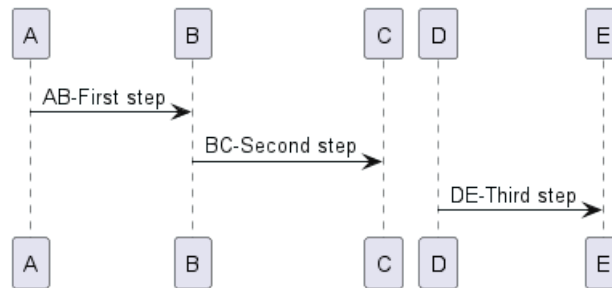

[Ref. QA-3906 and QA-3910]

21.1.3 Full example

```
@startuml
skinparam activity {
  ' this is a comment
  BackgroundColor White
  BorderColor Black /' this is a comment '/
  BorderColor Red ' this is not a comment and this line is ignored
}

start
:foo1;
@enduml
```



[Ref. GH-214]

21.2 Zoom

You can use the `scale` command to zoom the generated image.

You can use either *a number* or *a fraction* to define the scale factor. You can also specify either `width` or `height` (*in pixel*). And you can also give both `width` and `height`: the image is scaled to fit inside the specified dimension.

- `scale 1.5`
- `scale 2/3`
- `scale 200 width`



- scale 200 height
- scale 200*100
- scale max 300*200
- scale max 1024 width
- scale max 800 height

```
@startuml
scale 180*90
Bob->Alice : hello
@enduml
```

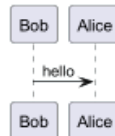

21.3 Title

The `title` keywords is used to put a title. You can add newline using `\n` in the title description.

Some `skinparam` settings are available to put borders on the title.

```
@startuml
skinparam titleBorderRoundCorner 15
skinparam titleBorderThickness 2
skinparam titleBorderColor red
skinparam titleBackgroundColor Aqua-CadetBlue
```

```
title Simple communication\nexample
```

```
Alice -> Bob: Authentication Request
Bob --> Alice: Authentication Response
```

```
@enduml
```

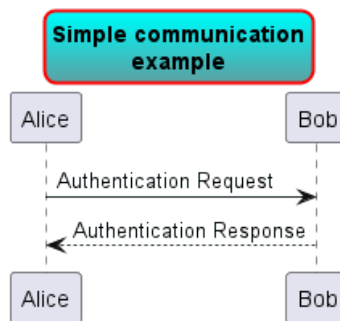

You can use creole formatting in the title.

You can also define title on several lines using `title` and `end title` keywords.

```
@startuml

title
  <u>Simple</u> communication example
  on <i>several</i> lines and using <back:cadetblue>creole tags</back>
end title
```

```
Alice -> Bob: Authentication Request
Bob -> Alice: Authentication Response
```



```
@enduml
```

**Simple communication example
on several lines and using creole tags**

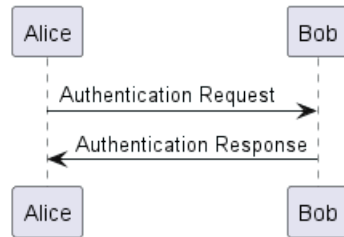

21.4 Caption

There is also a caption keyword to put a caption under the diagram.

```
@startuml
```

```
caption figure 1
Alice -> Bob: Hello
```

```
@enduml
```

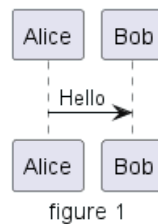

21.5 Footer and header

You can use the commands `header` or `footer` to add a footer or a header on any generated diagram.

You can optionally specify if you want a `center`, `left` or `right` footer/header, by adding a keyword.

As with title, it is possible to define a header or a footer on several lines.

It is also possible to put some HTML into the header or footer.

```
@startuml
```

```
Alice -> Bob: Authentication Request
```

```
header
```

```
<font color=red>Warning:</font>
```

```
Do not use in production.
```

```
endheader
```

```
center footer Generated for demonstration
```

```
@enduml
```



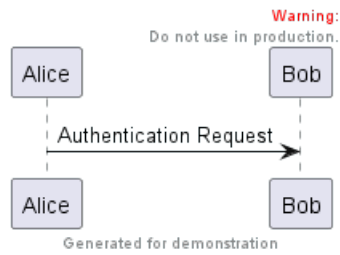

21.6 Legend the diagram

The legend and end legend are keywords is used to put a legend.

You can optionally specify to have `left`, `right`, `top`, `bottom` or `center` alignment for the legend.

```

@startuml
Alice -> Bob : Hello
legend right
  Short
  legend
endlegend
@enduml
  
```

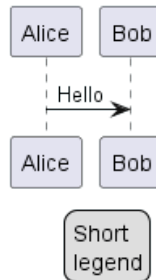

```

@startuml
Alice -> Bob : Hello
legend top left
  Short
  legend
endlegend
@enduml
  
```

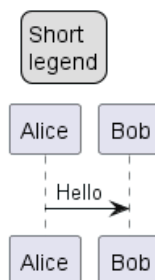

21.7 Appendix: Examples on all diagram

21.7.1 Activity

```

@startuml
header some header

footer some footer
  
```



```

title My title

caption This is caption

legend
The legend
end legend

start
:Hello world;
:This is defined on
several lines;
stop

@enduml

```

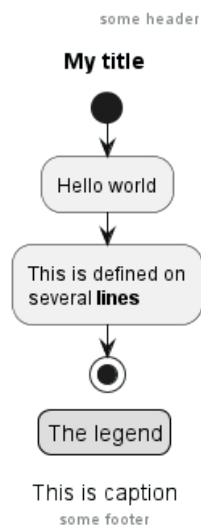

21.7.2 Archimate

```

@startuml
header some header

footer some footer

title My title

caption This is caption

legend
The legend
end legend

archimate #Technology "VPN Server" as vpnServerA <<technology-device>>

rectangle GO #lightgreen
rectangle STOP #red
rectangle WAIT #orange

@enduml

```



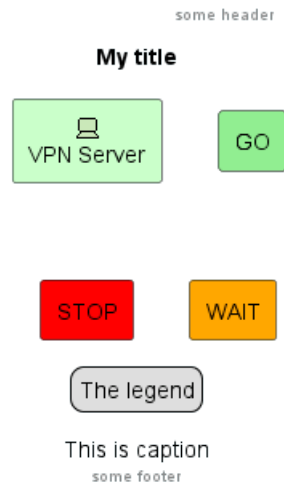

21.7.3 Class

```

@startuml
header some header

footer some footer

title My title

caption This is caption

legend
The legend
end legend

a -- b

@enduml

```

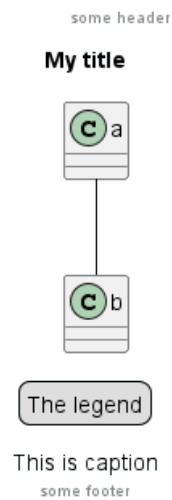

21.7.4 Component, Deployment, Use-Case

```

@startuml
header some header

footer some footer

```



```

title My title

caption This is caption

legend
The legend
end legend

node n
(u) -> [c]

@enduml

```

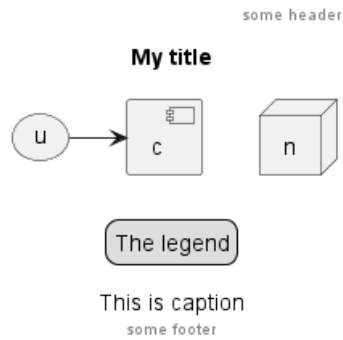

21.7.5 Gantt project planning

```

@startgantt
header some header

footer some footer

title My title

caption This is caption

legend
The legend
end legend

[t] lasts 5 days

@endgantt

```

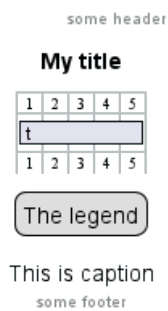

TODO: DONE [(Header, footer) corrected on V1.2020.18]

21.7.6 Object

```

@startuml

```



```

header some header

footer some footer

title My title

caption This is caption

legend
The legend
end legend

object user {
  name = "Dummy"
  id = 123
}

@enduml

```

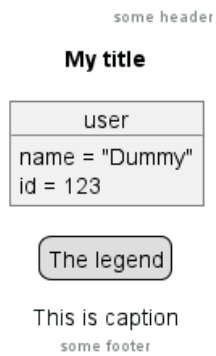

21.7.7 MindMap

```

@startmindmap
header some header

footer some footer

title My title

caption This is caption

legend
The legend
end legend

* r
** d1
** d2

@endmindmap

```



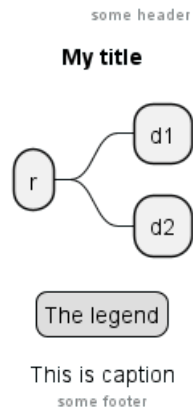

21.7.8 Network (nwdiag)

```

@startuml
header some header

footer some footer

title My title

caption This is caption

legend
The legend
end legend

nwdiag {
  network inet {
    web01 [shape = cloud]
  }
}

@enduml
  
```

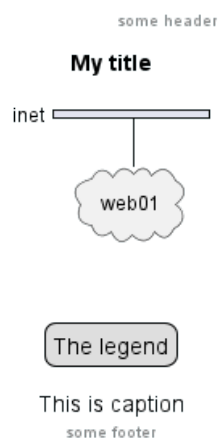

21.7.9 Sequence

```

@startuml
header some header

footer some footer
  
```



```

title My title

caption This is caption

legend
The legend
end legend

a->b
@enduml

```

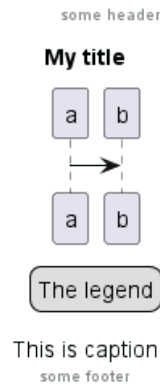

21.7.10 State

```

@startuml
header some header

footer some footer

title My title

caption This is caption

legend
The legend
end legend

[*] --> State1
State1 -> State2

@enduml

```

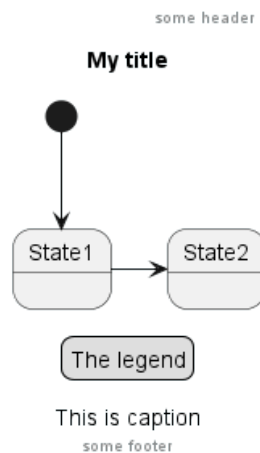

21.7.11 Timing

```

@startuml
header some header

footer some footer

title My title

caption This is caption

legend
The legend
end legend

robust "Web Browser" as WB
concise "Web User" as WU

@0
WU is Idle
WB is Idle

@100
WU is Waiting
WB is Processing

@300
WB is Waiting

@enduml

```

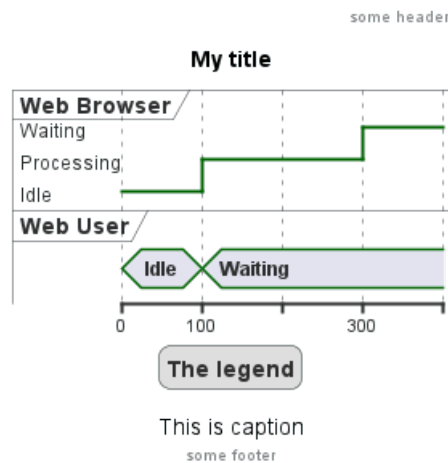

21.7.12 Work Breakdown Structure (WBS)

```

@startwbs
header some header

footer some footer

title My title

caption This is caption

legend

```



```
The legend
end legend
```

```
* r
** d1
** d2
```

```
@endwbs
```

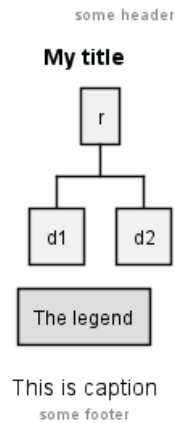

TODO: DONE [Corrected on V1.2020.17]

21.7.13 Wireframe (SALT)

```
@startsalt
header some header
```

```
footer some footer
```

```
title My title
```

```
caption This is caption
```

```
legend
The legend
end legend
```

```
{+
  Login    | "MyName  "
  Password | "****    "
  [Cancel] | [ OK    ]
}
@endsalt
```



TODO: DONE [Corrected on V1.2020.18]

21.8 Appendix: Examples on all diagram with style

TODO: DONE

FYI:

- all is only good for **Sequence diagram**
- title, caption and legend are good for all diagrams except for **salt diagram**

TODO: FIXME

- Now (*test on 1.2020.18-19*) header, footer are not good for **all other diagrams** except only for **Sequence diagram**.

To be fix; Thanks

TODO: FIXME

Here are tests of title, header, footer, caption or legend on all the diagram with the debug style:

```
<style>
title {
  HorizontalAlignment right
  FontSize 24
  FontColor blue
}

header {
  HorizontalAlignment center
  FontSize 26
  FontColor purple
}

footer {
  HorizontalAlignment left
  FontSize 28
  FontColor red
}

legend {
  FontSize 30
  BackGroundColor yellow
  Margin 30
  Padding 50
}

caption {
  FontSize 32
}
</style>
```

21.8.1 Activity

```
@startuml
<style>
title {
  HorizontalAlignment right
  FontSize 24
  FontColor blue
}

```



```
header {
  HorizontalAlignment center
  FontSize 26
  FontColor purple
}
```

```
footer {
  HorizontalAlignment left
  FontSize 28
  FontColor red
}
```

```
legend {
  FontSize 30
  BackGroundColor yellow
  Margin 30
  Padding 50
}
```

```
caption {
  FontSize 32
}
```

`</style>`

header some header

footer some footer

title My title

caption This is caption

```
legend
The legend
end legend
```

```
start
:Hello world;
:This is defined on
several lines;
stop
```

`@enduml`

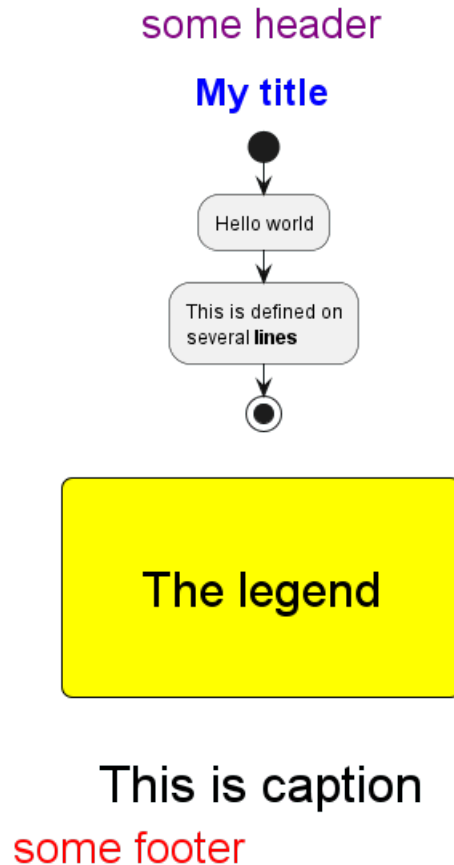

21.8.2 Archimate

```

@startuml
<style>
title {
  HorizontalAlignment right
  FontSize 24
  FontColor blue
}

header {
  HorizontalAlignment center
  FontSize 26
  FontColor purple
}

footer {
  HorizontalAlignment left
  FontSize 28
  FontColor red
}

legend {
  FontSize 30
  BackGroundColor yellow
  Margin 30
  Padding 50
}
  
```



```

caption {
  FontSize 32
}
</style>
header some header

footer some footer

title My title

caption This is caption

legend
The legend
end legend

archimate #Technology "VPN Server" as vpnServerA <<technology-device>>

rectangle GO #lightgreen
rectangle STOP #red
rectangle WAIT #orange

@enduml

```

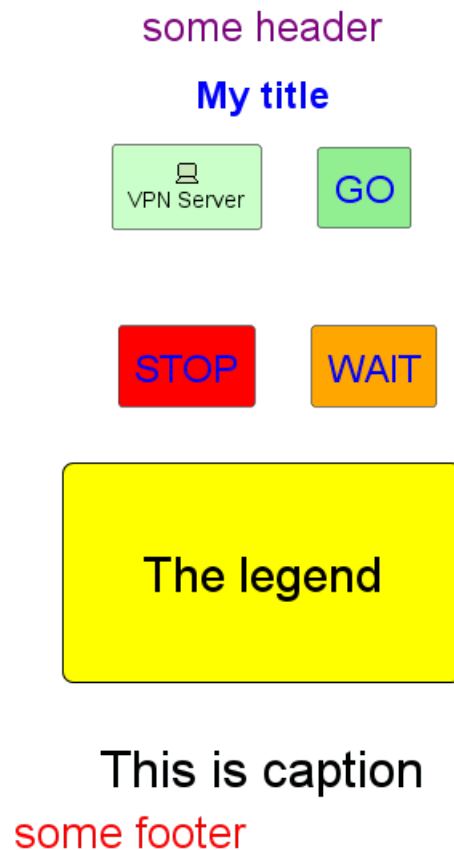

21.8.3 Class

```

@startuml
<style>
title {
  HorizontalAlignment right
  FontSize 24

```



```
    FontColor blue
}

header {
    HorizontalAlignment center
    FontSize 26
    FontColor purple
}

footer {
    HorizontalAlignment left
    FontSize 28
    FontColor red
}

legend {
    FontSize 30
    BackGroundColor yellow
    Margin 30
    Padding 50
}

caption {
    FontSize 32
}
</style>
header some header

footer some footer

title My title

caption This is caption

legend
The legend
end legend

a -- b

@enduml
```

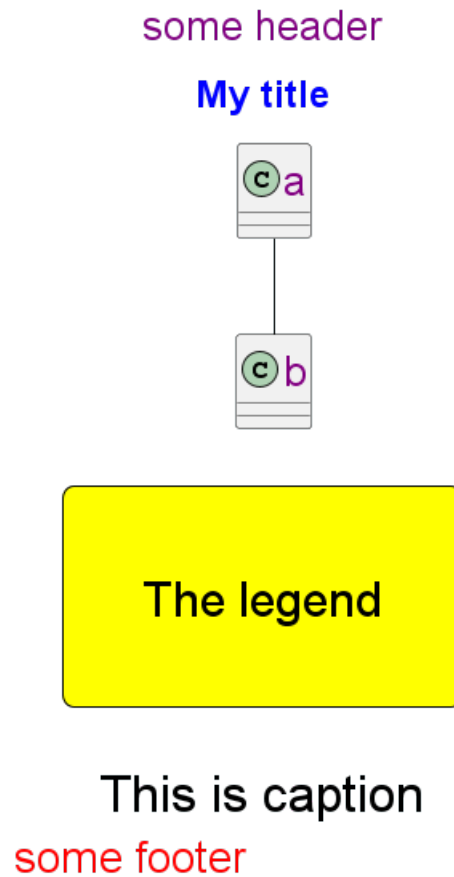

21.8.4 Component, Deployment, Use-Case

```

@startuml
<style>
title {
  HorizontalAlignment right
  FontSize 24
  FontColor blue
}

header {
  HorizontalAlignment center
  FontSize 26
  FontColor purple
}

footer {
  HorizontalAlignment left
  FontSize 28
  FontColor red
}

legend {
  FontSize 30
  BackGroundColor yellow
  Margin 30
  Padding 50
}
  
```



```
caption {
  FontSize 32
}
</style>
header some header

footer some footer

title My title

caption This is caption

legend
The legend
end legend

node n
(u) -> [c]

@enduml
```

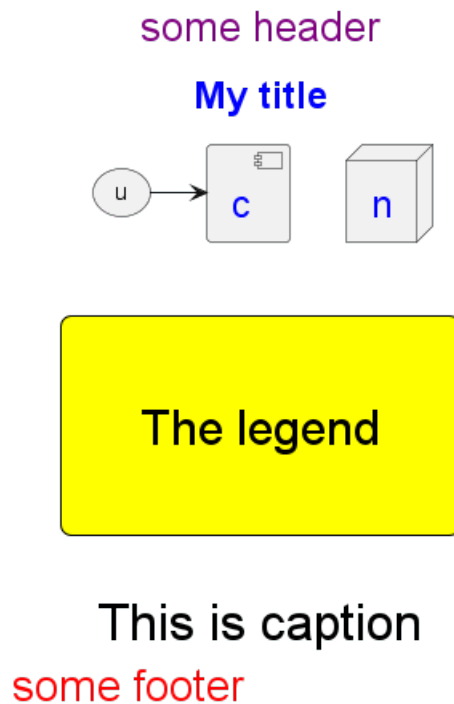

21.8.5 Gantt project planning

```
@startgantt
<style>
title {
  HorizontalAlignment right
  FontSize 24
  FontColor blue
}

header {
  HorizontalAlignment center
  FontSize 26
  FontColor purple
}
```



```

}

footer {
  HorizontalAlignment left
  FontSize 28
  FontColor red
}

legend {
  FontSize 30
  BackGroundColor yellow
  Margin 30
  Padding 50
}

caption {
  FontSize 32
}
</style>
header some header

footer some footer

title My title

caption This is caption

legend
The legend
end legend

[t] lasts 5 days

@endgantt

```

some header

My title

1	2	3	4	5
t				
1	2	3	4	5

The legend

This is caption
some footer



21.8.6 Object

```

@startuml
<style>
title {
  HorizontalAlignment right
  FontSize 24
  FontColor blue
}

header {
  HorizontalAlignment center
  FontSize 26
  FontColor purple
}

footer {
  HorizontalAlignment left
  FontSize 28
  FontColor red
}

legend {
  FontSize 30
  BackGroundColor yellow
  Margin 30
  Padding 50
}

caption {
  FontSize 32
}
</style>
header some header

footer some footer

title My title

caption This is caption

legend
The legend
end legend

object user {
  name = "Dummy"
  id = 123
}

@enduml

```

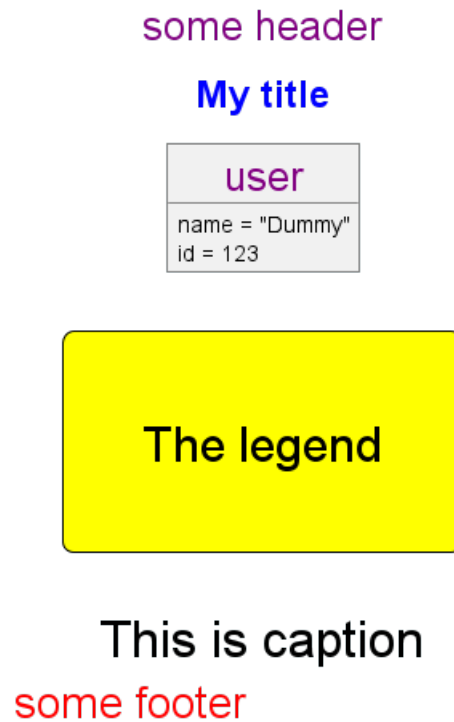

21.8.7 MindMap

```

@startmindmap
<style>
title {
  HorizontalAlignment right
  FontSize 24
  FontColor blue
}

header {
  HorizontalAlignment center
  FontSize 26
  FontColor purple
}

footer {
  HorizontalAlignment left
  FontSize 28
  FontColor red
}

legend {
  FontSize 30
  BackGroundColor yellow
  Margin 30
  Padding 50
}

caption {
  FontSize 32
}
</style>
header some header

```

```

footer some footer

title My title

caption This is caption

legend
The legend
end legend

* r
** d1
** d2

@endmindmap

```

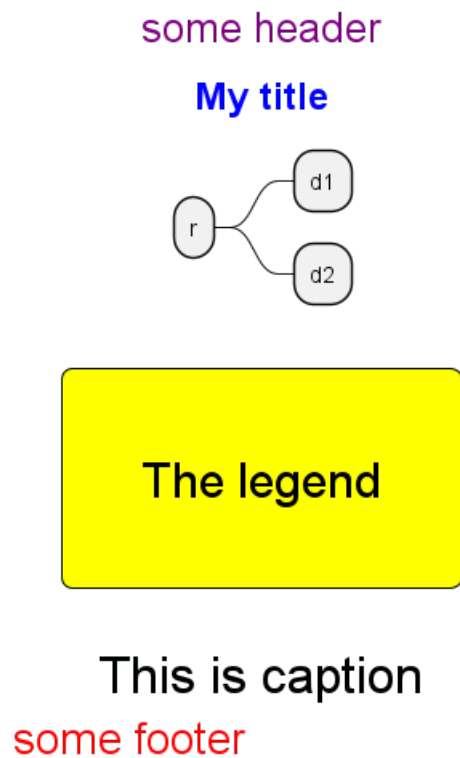

21.8.8 Network (nwdiag)

```

@startuml
<style>
title {
  HorizontalAlignment right
  FontSize 24
  FontColor blue
}

header {
  HorizontalAlignment center
  FontSize 26
  FontColor purple
}

```



```
footer {
  HorizontalAlignment left
  FontSize 28
  FontColor red
}

legend {
  FontSize 30
  BackGroundColor yellow
  Margin 30
  Padding 50
}

caption {
  FontSize 32
}
</style>
header some header

footer some footer

title My title

caption This is caption

legend
The legend
end legend

nwdiag {
  network inet {
    web01 [shape = cloud]
  }
}

@enduml
```

some header

My title

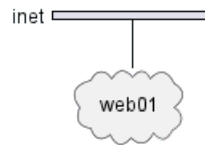

The legend

This is caption
some footer

21.8.9 Sequence

```

@startuml
<style>
title {
  HorizontalAlignment right
  FontSize 24
  FontColor blue
}

header {
  HorizontalAlignment center
  FontSize 26
  FontColor purple
}

footer {
  HorizontalAlignment left
  FontSize 28
  FontColor red
}

legend {
  FontSize 30
  BackGroundColor yellow
  Margin 30
  Padding 50
}

caption {
  FontSize 32
}
</style>
  
```



```

header some header

footer some footer

title My title

caption This is caption

legend
The legend
end legend

a->b
@enduml

```

some header

My title

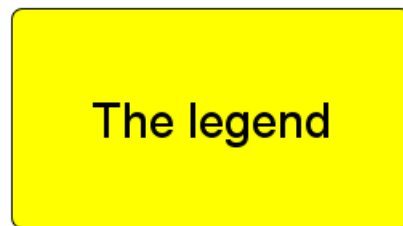
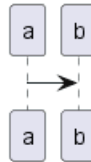

This is caption

some footer

21.8.10 State

```

@startuml
<style>
title {
  HorizontalAlignment right
  FontSize 24
  FontColor blue
}

header {
  HorizontalAlignment center
  FontSize 26
  FontColor purple
}

footer {
  HorizontalAlignment left
  FontSize 28

```



```

    FontColor red
}

legend {
    FontSize 30
    BackGroundColor yellow
    Margin 30
    Padding 50
}

caption {
    FontSize 32
}
</style>
header some header

footer some footer

title My title

caption This is caption

legend
The legend
end legend

[*] --> State1
State1 -> State2

@enduml

```

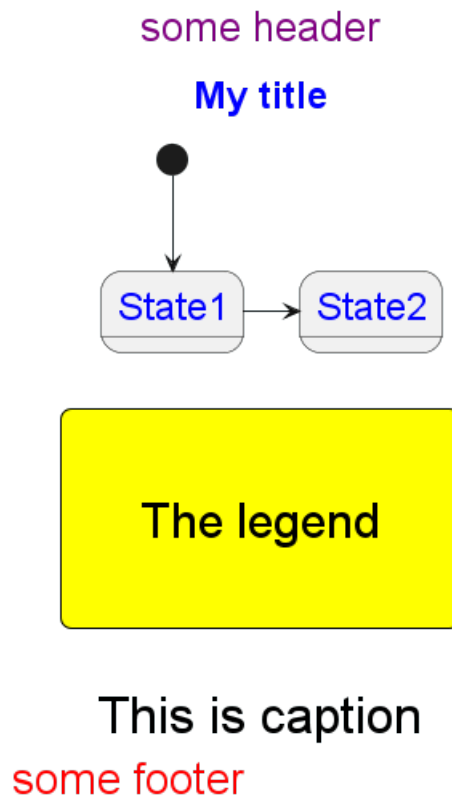

21.8.11 Timing

```

@startuml
<style>
title {
  HorizontalAlignment right
  FontSize 24
  FontColor blue
}

header {
  HorizontalAlignment center
  FontSize 26
  FontColor purple
}

footer {
  HorizontalAlignment left
  FontSize 28
  FontColor red
}

legend {
  FontSize 30
  BackGroundColor yellow
  Margin 30
  Padding 50
}

caption {
  FontSize 32
}
</style>
header some header

footer some footer

title My title

caption This is caption

legend
The legend
end legend

robust "Web Browser" as WB
concise "Web User" as WU

@0
WU is Idle
WB is Idle

@100
WU is Waiting
WB is Processing

@300
WB is Waiting

```



```
@enduml
```

some header

My title

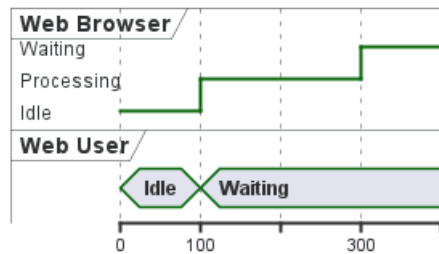

The legend

This is caption

some footer

21.8.12 Work Breakdown Structure (WBS)

```
@startwbs
<style>
title {
  HorizontalAlignment right
  FontSize 24
  FontColor blue
}

header {
  HorizontalAlignment center
  FontSize 26
  FontColor purple
}

footer {
  HorizontalAlignment left
  FontSize 28
  FontColor red
}

legend {
  FontSize 30
  BackGroundColor yellow
  Margin 30
  Padding 50
}
```



```
caption {
  FontSize 32
}
</style>
header some header

footer some footer

title My title

caption This is caption

legend
The legend
end legend

* r
** d1
** d2

@endwbs
```

some header

My title

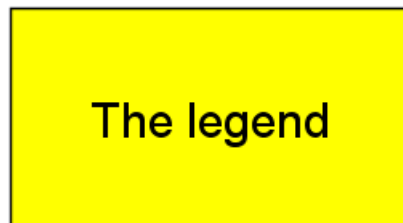
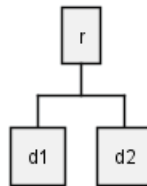

This is caption

some footer

21.8.13 Wireframe (SALT)

TODO: FIXME Fix all (title, caption, legend, header, footer) for salt. **TODO: FIXME**

```
@startsalt
<style>
title {
  HorizontalAlignment right
  FontSize 24
  FontColor blue
}

```



```

header {
  HorizontalAlignment center
  FontSize 26
  FontColor purple
}

footer {
  HorizontalAlignment left
  FontSize 28
  FontColor red
}

legend {
  FontSize 30
  BackGroundColor yellow
  Margin 30
  Padding 50
}

caption {
  FontSize 32
}
</style>
@startsalt
header some header

footer some footer

title My title

caption This is caption

legend
The legend
end legend

{+
  Login | "MyName  "
  Password | "****  "
  [Cancel] | [ OK ]
}
@endsalt

```



21.9 Mainframe

```

@startuml
mainframe This is a mainframe

```



```
Alice->Bob : Hello
@enduml
```

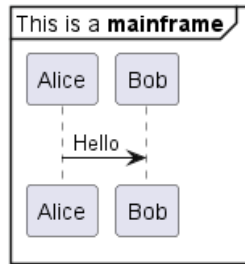

[Ref. QA-4019 and Issue#148]

21.10 Appendix: Examples of Mainframe on all diagram

21.10.1 Activity

```
@startuml
mainframe This is a **mainframe**

start
:Hello world;
:This is defined on
several **lines**;
```

```
stop
@enduml
```

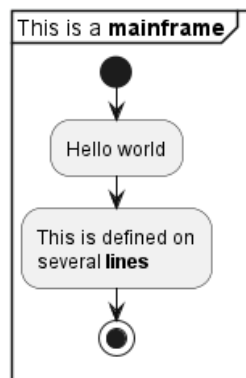

21.10.2 Archimate

```
@startuml
mainframe This is a **mainframe**

archimate #Technology "VPN Server" as vpnServerA <<technology-device>>
rectangle GO #lightgreen
rectangle STOP #red
rectangle WAIT #orange
@enduml
```



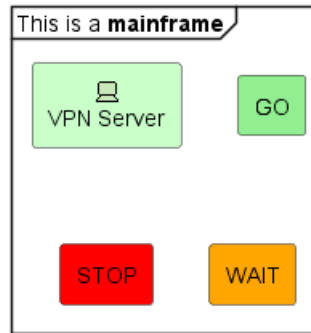

TODO: FIXME Cropped on the top and on the left **TODO: FIXME**

21.10.3 Class

```
@startuml
mainframe This is a **mainframe**

a -- b
@enduml
```

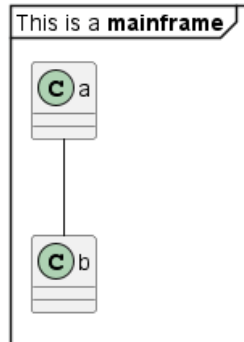

TODO: FIXME Cropped on the top and on the left **TODO: FIXME**

21.10.4 Component, Deployment, Use-Case

```
@startuml
mainframe This is a **mainframe**

node n
(u) -> [c]
@enduml
```

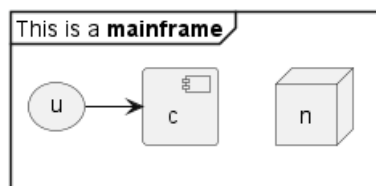

TODO: FIXME Cropped on the top and on the left **TODO: FIXME**

21.10.5 Gantt project planning

```
@startgantt
mainframe This is a **mainframe**

[t] lasts 5 days
@endgantt
```

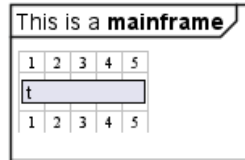

TODO: FIXME Cropped on the top and on the left **TODO: FIXME**

21.10.6 Object

```
@startuml
mainframe This is a mainframe

object user {
    name = "Dummy"
    id = 123
}
@enduml
```

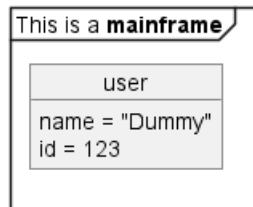

TODO: FIXME Cropped on the top! **TODO: FIXME**

21.10.7 MindMap

```
@startmindmap
mainframe This is a mainframe

* r
** d1
** d2
@endmindmap
```

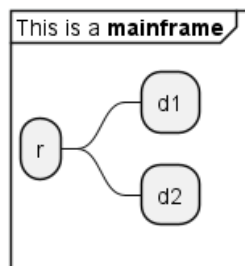

21.10.8 Network (nwdiag)

```
@startuml
mainframe This is a mainframe

nwdiag {
    network inet {
        web01 [shape = cloud]
    }
}
@enduml
```

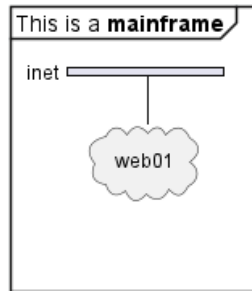

TODO: FIXME Cropped on the top! **TODO: FIXME**

21.10.9 Sequence

```
@startuml
mainframe This is a mainframe

a->b
@enduml
```

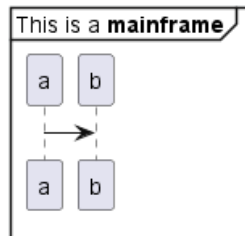

21.10.10 State

```
@startuml
mainframe This is a mainframe

[*] --> State1
State1 -> State2
@enduml
```

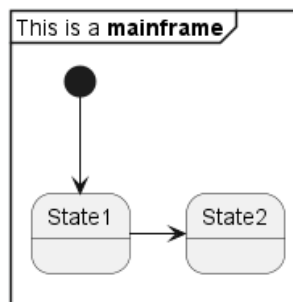

TODO: FIXME Cropped on the top and on the left **TODO: FIXME**

21.10.11 Timing

```
@startuml
mainframe This is a mainframe

robust "Web Browser" as WB
concise "Web User" as WU
@0
WU is Idle
```

```
WB is Idle
@100
WU is Waiting
WB is Processing
@300
WB is Waiting
@enduml
```

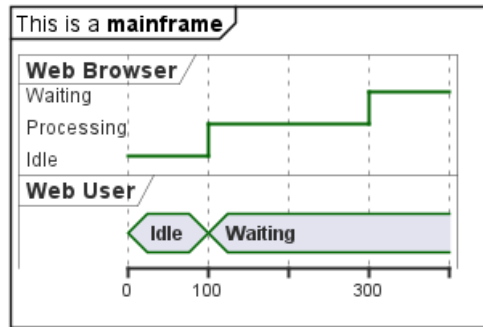

21.10.12 Work Breakdown Structure (WBS)

```
@startwbs
mainframe This is a mainframe
* r
** d1
** d2
@endwbs
```

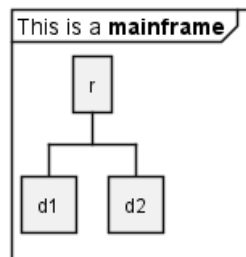

21.10.13 Wireframe (SALT)

```
@startsalt
mainframe This is a mainframe
{+
  Login | "MyName" |
  Password | "****" |
  [Cancel] | [ OK ]
}
@endsalt
```

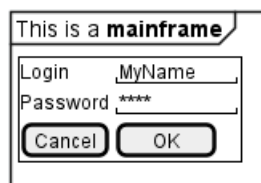

21.11 Appendix: Examples of title, header, footer, caption, legend and mainframe on all diagram

21.11.1 Activity

```
@startuml
mainframe This is a **mainframe**
header some header

footer some footer

title My title

caption This is caption

legend
The legend
end legend

start
:Hello world;
:This is defined on
several **lines**;
stop

@enduml
```

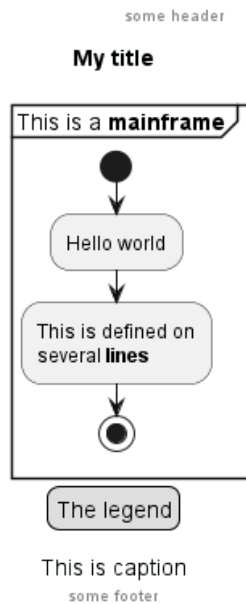

21.11.2 Archimate

```
@startuml
mainframe This is a **mainframe**
header some header

footer some footer

title My title

caption This is caption
```



```

legend
The legend
end legend

archimate #Technology "VPN Server" as vpnServerA <<technology-device>>

rectangle GO #lightgreen
rectangle STOP #red
rectangle WAIT #orange

@enduml

```

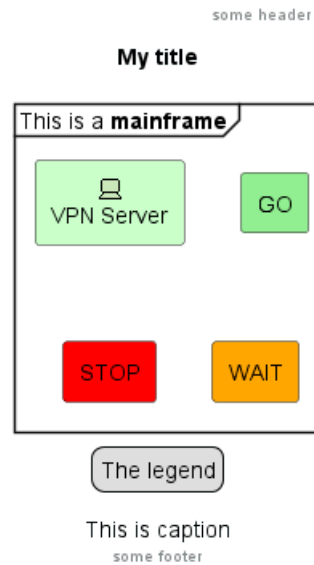

21.11.3 Class

```

@startuml
mainframe This is a mainframe
header some header

footer some footer

title My title

caption This is caption

legend
The legend
end legend

a -- b

@enduml

```



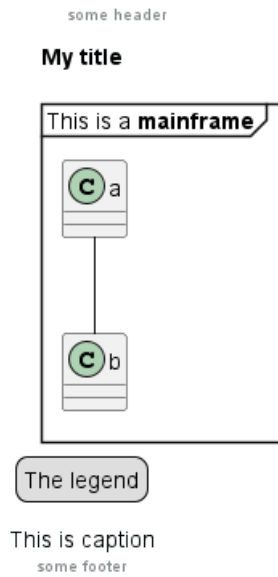

21.11.4 Component, Deployment, Use-Case

```

@startuml
mainframe This is a **mainframe**
header some header

footer some footer

title My title

caption This is caption

legend
The legend
end legend

node n
(u) -> [c]

@enduml

```

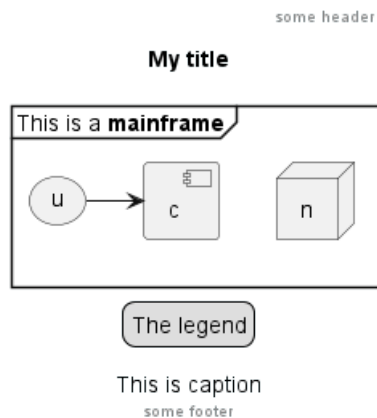

21.11.5 Gantt project planning

```

@startgantt
mainframe This is a **mainframe**
header some header

```



```

footer some footer

title My title

caption This is caption

legend
The legend
end legend

[t] lasts 5 days

@endgantt

```

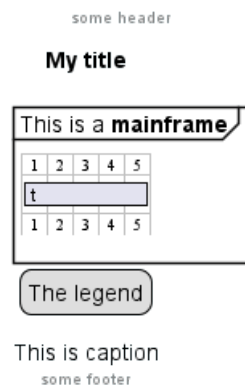

21.11.6 Object

```

@startuml
mainframe This is a mainframe
header some header

footer some footer

title My title

caption This is caption

legend
The legend
end legend

object user {
    name = "Dummy"
    id = 123
}

@enduml

```



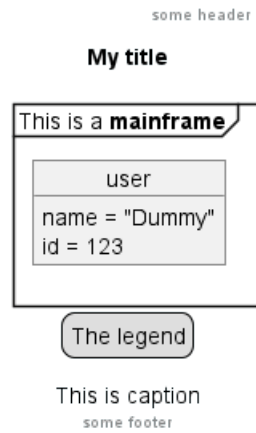

21.11.7 MindMap

```

@startmindmap
mainframe This is a mainframe
header some header

footer some footer

title My title

caption This is caption

legend
The legend
end legend

* r
** d1
** d2

@endmindmap
    
```

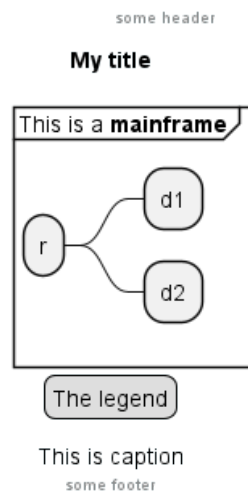

21.11.8 Network (nwdiag)

```

@startuml
mainframe This is a mainframe
header some header
    
```

```

footer some footer

title My title

caption This is caption

legend
The legend
end legend

nwdiag {
  network inet {
    web01 [shape = cloud]
  }
}

@enduml

```

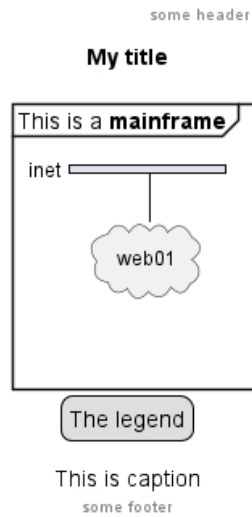

21.11.9 Sequence

```

@startuml
mainframe This is a mainframe
header some header

footer some footer

title My title

caption This is caption

legend
The legend
end legend

a->b
@enduml

```

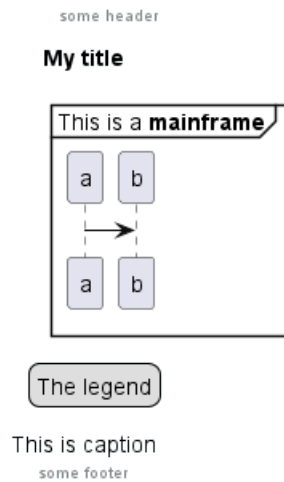

21.11.10 State

```
@startuml
mainframe This is a mainframe
header some header

footer some footer

title My title

caption This is caption

legend
The legend
end legend

[*] --> State1
State1 -> State2

@enduml
```

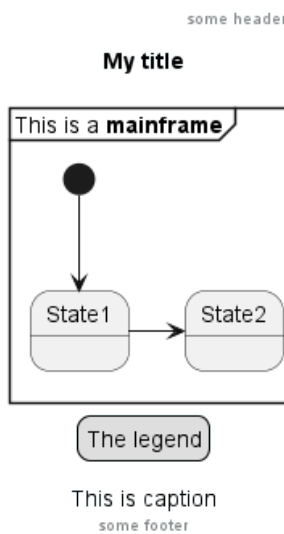

21.11.11 Timing

```
@startuml
mainframe This is a mainframe
```



```
legend
The legend
end legend
```

```
* r
** d1
** d2
```

```
@endwbs
```

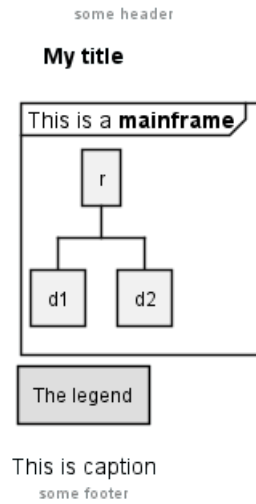

21.11.13 Wireframe (SALT)

```
@startsalt
mainframe This is a mainframe
header some header
```

```
footer some footer
```

```
title My title
```

```
caption This is caption
```

```
legend
The legend
end legend
```

```
{+
  Login    | "MyName  "
  Password | "****   "
  [Cancel] | [ OK   ]
}
@endsalt
```



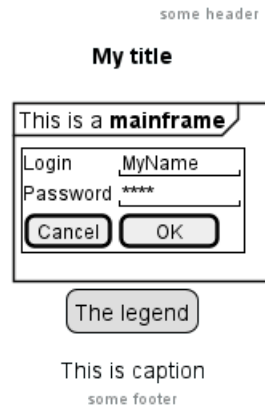

22 Créole

Le créole est un langage de balisage léger commun à divers wikis. Un moteur créole léger est intégré à PlantUML afin de disposer d'un moyen normalisé d'émettre du texte stylé.

Tous les diagrammes prennent en charge cette syntaxe.

Notez que la compatibilité avec la syntaxe HTML est préservée.

22.1 Texte mis en évidence

```
@startuml
Alice -> Bob : hello there here
... Some long delay ...
Bob -> Alice : ok
note left
  This is bold
  This is italics
  This is "monospaced"
  This is stricken-out
  This is underlined
  This is wave-underlined
end note
@enduml
```

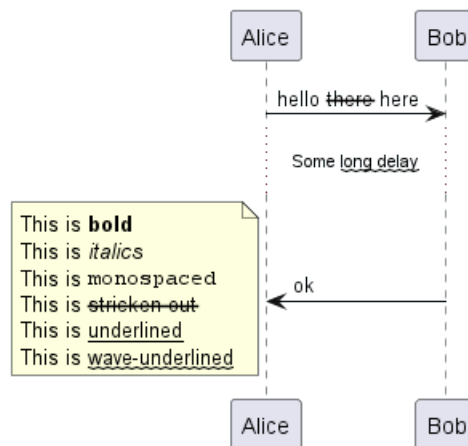

22.2 Listes

Vous pouvez utiliser des listes numérotées et à puces dans le texte des nœuds, les notes, etc.

TODO: FIXME Vous ne pouvez pas tout à fait mélanger les chiffres et les puces dans une liste et sa sous-liste

```
@startuml
object demo {
  * Bullet list
  * Second item
}
note left
  * Bullet list
  * Second item
  ** Sub item
end note

legend
  # Numbered list
  # Second item
```



```

## Sub item
## Another sub item
    * Can't quite mix
    * Numbers and bullets
# Third item
end legend
@enduml

```

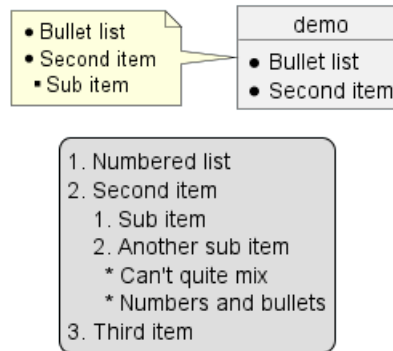

22.3 Caractère d'échappement

Vous pouvez utiliser le tilde ~ pour échapper les caractères Créoles spéciaux.

```

@startuml
object demo {
  This is not ~___underscored___.
  This is not ~'"monospaced"'.
}
@enduml

```

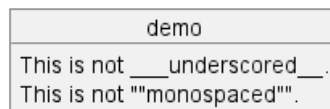

22.4 Entêtes

```

@startuml
usecase UC1 as "
= Extra-large heading
Some text
== Large heading
Other text
=== Medium heading
Information
...
==== Small heading"
@enduml

```

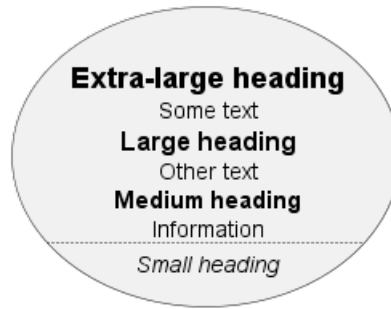

22.5 Emoji

All emojis from Twemoji (see `EmojiTwo` on Github) are available using the following syntax:

```
@startuml
Alice -> Bob : Hello <:1f600:>
return <:innocent:>
Alice -> Bob : Without color: <#0:sunglasses:>
Alice -> Bob : Change color: <#green:sunny:>
@enduml
```

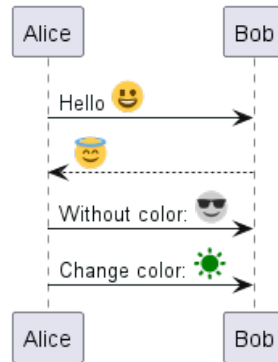

Unlike Unicode Special characters that depend on installed fonts, the emoji are always available. Furthermore, emoji are already colored, but you can recolor them if you like (see examples above).

One can pick emoji from the emoji cheat sheet, the Unicode full-emoji-list, or the flat list `emoji.txt` in the `plantuml` source.

You can also use the following PlantUML command to list available emoji:

```
@startuml
emoji <block>
@enduml
```

As of 13 April 2023, you can select between 1174 emoji from the following Unicode blocks:

- Unicode block 26: 83 emoji
- Unicode block 27: 33 emoji
- Unicode block 1F3: 246 emoji
- Unicode block 1F4: 255 emoji
- Unicode block 1F5: 136 emoji
- Unicode block 1F6: 181 emoji
- Unicode block 1F9: 240 emoji



22.5.1 Unicode block 26

```
@startuml
emoji 26
@enduml
```

Emoji available on Unicode Block 26

(Blocks available: 26, 27, 1F3, 1F4, 1F6, 1F9)

```
<:2600:> ☀️ ☁️ <:sunny:>
<:2601:> ☁️ <:cloud:>
<:2602:> ☂️ <:open_umbrella:>
<:2603:> 🧑‍❄️ <:snowman_with_snow:>
<:2604:> 🌠 <:comet:>
<:260e:> 📱 <:phone:>
<:2611:> 🗳️ <:ballot_box_with_check:>
<:2614:> ☂️ <:umbrella:>
<:2615:> ☕ <:coffee:>
<:2618:> 🍀 <:shamrock:>
<:261d:> 👉 <:point_up:>
<:2620:> ☠️ <:skull_and_crossbones:>
<:2622:> ☢️ <:radioactive:>
<:2623:> ☣️ <:biohazard:>
<:2626:> ✚️ <:orthodox_cross:>
<:262a:> 🌠 <:star_and_crescent:>
<:262e:> ☮️ <:peace_symbol:>
<:262f:> ☯️ <:yin_yang:>
<:2638:> 🌀 <:wheel_of_dharma:>
<:2639:> ☹️ <:frowning_face:>
<:263a:> 😌 <:relaxed:>
<:2640:> ♀️ <:female_sign:>
<:2642:> ♂️ <:male_sign:>
<:2648:> ♈️ <:aries:>
<:2649:> ♉️ <:taurus:>
<:264a:> ♊️ <:gemini:>
<:264b:> ♋️ <:cancer:>
<:264c:> ♌️ <:leo:>
<:264d:> ♍️ <:virgo:>
<:264e:> ♎️ <:libra:>
<:264f:> ♏️ <:scorpius:>
<:2650:> ♐️ <:sagittarius:>
<:2651:> ♑️ <:capricorn:>
<:2652:> ♒️ <:aquarius:>
<:2653:> ♓️ <:pisces:>
<:265f:> ♟️ <:chess_pawn:>
<:2660:> ♠️ <:spades:>
<:2663:> ♣️ <:clubs:>
<:2665:> ♥️ <:hearts:>
<:2666:> ♦️ <:diamonds:>
<:2668:> 🌋 <:hotsprings:>
<:267b:> ♻️ <:recycle:>
<:267e:> ∞ <:infinity:>
<:267f:> ♿️ <:wheelchair:>
<:2692:> ⚒️ <:hammer_and_pick:>
<:2693:> ⚓️ <:anchor:>
<:2694:> ⚔️ <:crossed_swords:>
<:2695:> 🏥 <:medical_symbol:>
<:2696:> ⚖️ <:balance_scale:>
<:2697:> ⚙️ <:alembic:>
<:2699:> ⚙️ <:gear:>
<:269b:> ⚛️ <:atom_symbol:>
<:269c:> 🌹 <:fleur_de_lis:>
<:26a0:> ⚠️ <:warning:>
<:26a1:> ⚡️ <:zap:>
<:26a7:> 🏳️‍⚧️ <:transgender_symbol:>
<:26aa:> ⬤ <:white_circle:>
<:26ab:> ⬤ <:black_circle:>
<:26b0:> ☠️ <:coffin:>
<:26b1:> 🪦 <:funeral_urn:>
<:26bd:> ⚽️ <:soccer:>
<:26be:> ⚾️ <:baseball:>
<:26c4:> 🧑‍❄️ <:snowman:>
<:26c5:> ☀️ <:partly_sunny:>
<:26c8:> ⚡️ <:cloud_with_lightning_and_rain:>
<:26ce:> 🐍 <:ophiuchus:>
<:26cf:> 🛠️ <:pick:>
<:26d1:> 🧑‍🚒 <:rescue_worker_helmet:>
<:26d3:> ⛔️ <:chains:>
<:26d4:> 🚫 <:no_entry:>
<:26e9:> 🏯 <:shinto_shrine:>
<:26ea:> 🏪 <:church:>
<:26f0:> 🏔️ <:mountain:>
<:26f1:> 🌂 <:parasol_on_ground:>
<:26f2:> 🏞️ <:fountain:>
<:26f3:> 🏌️ <:golf:>
<:26f4:> 🚢 <:ferry:>
<:26f5:> 🚤 <:boat:>
<:26f7:> 🏂 <:skier:>
<:26f8:> 🛼 <:ice_skate:>
<:26f9:> 🏀 <:bouncing_ball_person:>
<:26fa:> 🏠 <:tent:>
<:26fd:> 🚰 <:fuelpump:>
```

22.6 Lignes horizontales

```
@startuml
database DB1 as "
You can have horizontal line
----
Or double line
=====
Or strong line
-----
Or dotted line
..My title..
Enjoy!
"
note right
  This is working also in notes
  You can also add title in all these lines
  ==Title==
  --Another title--
end note
@enduml
```



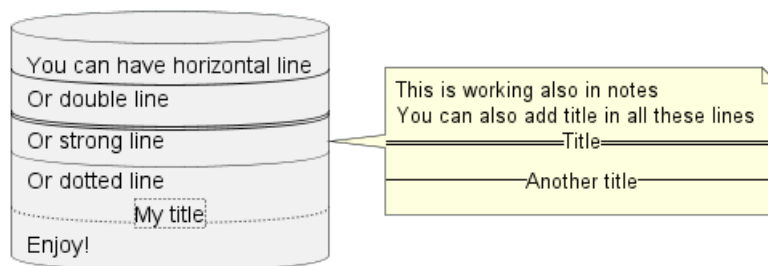

22.7 Links

You can also use URL and links.

Simple links are define using two square brackets (or three square brackets for field or method on class diagram).

Example:

- `[[http://plantuml.com]]`
- `[[http://plantuml.com This label is printed]]`
- `[[http://plantuml.com{Optional tooltip} This label is printed]]`

URL can also be authenticated.

22.8 Code

Vous pouvez utiliser `<code>` pour afficher du code de programmation dans votre diagramme (désolé, la coloration syntaxique n'est pas encore supportée)

```
@startuml
Alice -> Bob : hello
note right
<code>
main() {
    printf("Hello world");
}
</code>
end note
@enduml
```

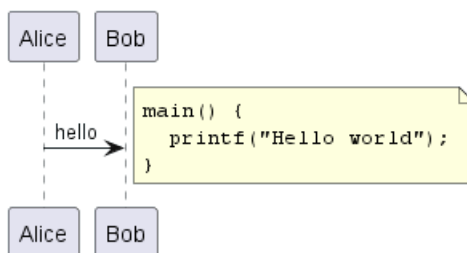

C'est particulièrement utile pour illustrer un code PlantUML et le rendu qui en résulte

```
@startuml
Alice -> Bob : hello
note left
<code>
    This is bold
    This is italics
    This is "monospaced"
    This is stricken-out
    This is underlined
</code>
end note
@enduml
```



```

This is ~-wave-underlined~-
--test Unicode and icons--
This is <U+221E> long
This is a <&code> icon
</code>
end note
note right
This is **bold**
This is //italics//
This is "monospaced"
This is --stricken-out--
This is __underlined__
This is ~-wave-underlined~-
--test Unicode and icons--
This is <U+221E> long
This is a <&code> icon
end note
@enduml

```

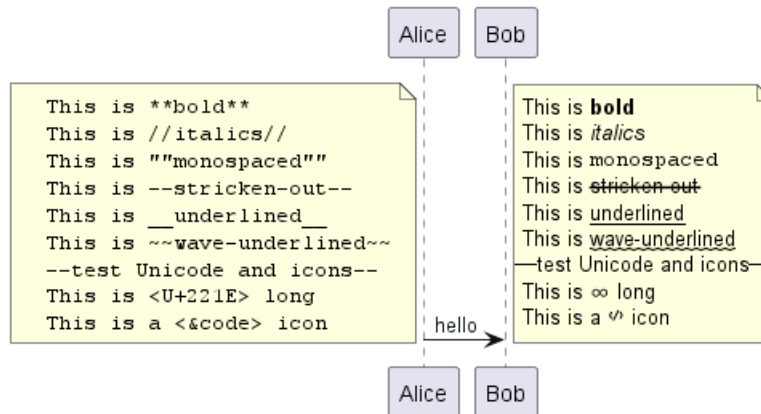

22.9 Tableau

22.9.1 Créer un tableau

Il est possible de construire un tableau, avec le séparateur |

```

@startuml
skinparam titleFontSize 14
title
Example of simple table
|= |= table |= header |
| a | table | row |
| b | table | row |
end title
[*] --> State1
@enduml

```



Example of simple table

	table	header
a	table	row
b	table	row

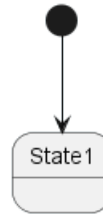

22.9.2 Ajouter une couleur sur les lignes ou les cellules

Vous pouvez spécifier les couleurs de fond des lignes et des cellules

```

@startuml
start
:Here is the result
|= |= table |= header |
| a | table | row |
|<#FF8080> red |<#80FF80> green |<#8080FF> blue |
<#yellow>| b | table | row |;
@enduml
  
```

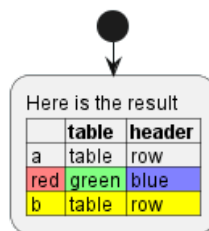

22.9.3 Ajouter une couleur sur la bordure et le texte

Vous pouvez également spécifier les couleurs du texte et des bordures

```

@startuml
title
<#lightblue,#red>|= Step |= Date |= Name |= Status |= Link |
<#lightgreen>| 1.1 | TBD | plantuml news |<#Navy><color:OrangeRed><b> Unknown | [[https://plantuml.org]]
end title
@enduml
  
```

Step	Date	Name	Status	Link
1.1	TBD	plantuml news	Unknown	plantuml news

[Réf. QA-7184]

22.9.4 Pas de bordure ou même couleur que le fond

Vous pouvez également définir la couleur de la bordure sur la même couleur que le fond

```

@startuml
node n
note right of n
  <#FBFB77,#FBFB77>|= Husky / Yorkie |= Foo |
  | SourceTree1 | foo1 |
  | ST2 | foo2 |
@enduml
  
```



```
end note
@enduml
```

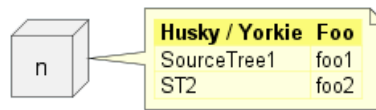

[Réf. QA-12448]

22.9.5 En-tête en gras ou non

= comme premier caractère d'une cellule indique s'il faut la mettre en gras (généralement utilisé pour les en-têtes) ou non

```
@startuml
note as deepCSS0
  |<#white> Husky / Yorkie |
  |=<#gainsboro> SourceTree0 |
endnote

note as deepCSS1
  |= <#white> Husky / Yorkie |= Foo |
  |<#gainsboro><r> SourceTree1 | foo1 |
endnote

note as deepCSS2
  |= Husky / Yorkie |
  |<#gainsboro> SourceTree2 |
endnote

note as deepCSS3
  <#white>|= Husky / Yorkie |= Foo |
  |<#gainsboro> SourceTree1 | foo1 |
endnote
@enduml
```

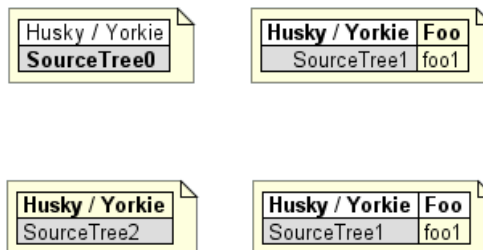

[Réf. QA-10923]

22.10 Arbre

Vous pouvez utiliser les caractères |_ pour construire un arbre.

Sur les commandes courantes, comme le titre

```
@startuml
skinparam titleFontSize 14
title
  Example of Tree
  |_ First line
  |_ Bom (Model)
    |_ prop1
    |_ prop2
```



```

    |_ prop3
  |_ Last line
end title
[*] --> State1
@enduml

```

Example of Tree

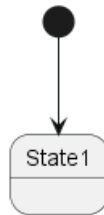
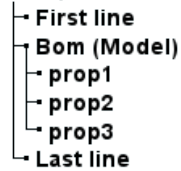

Sur un diagramme de classes.

(Veuillez noter que nous devons utiliser un deuxième compartiment vide, sinon les parenthèses dans (**Modèle**) font que le texte est déplacé dans un premier compartiment séparé)

```

@startuml
class Foo {
**Bar (Model)**
|_ prop
|_ **Bom (Model)**
  |_ prop2
  |_ prop3
    |_ prop3.1
|_ prop4 :(
--
}
@enduml

```

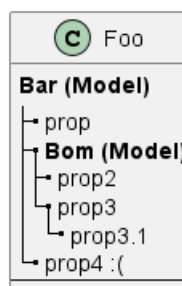

[Réf. QA-3448]

Sur les diagrammes de composants ou de déploiement

```

@startuml
[A] as A
rectangle "Box B" {
  component B [
    Level 1
    |_ Level 2a
      |_ Level 3a
      |_ Level 3b

```



```

    |_ Level 3c
      |_ Level 4a
    |_ Level 3d
  |_ Level 2b
    |_ Level 3e
]
}
A -> B
@enduml

```

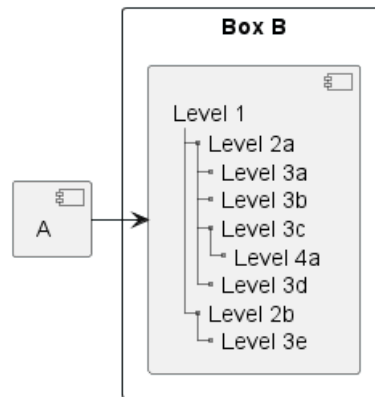

[Réf. QA-11365]

22.11 Caractères spéciaux

Il est possible d'utiliser n'importe quel caractère unicode, soit directement soit avec la syntaxe `&#XXX` ou `<U+XXXX>`

```

@startuml
usecase direct as "this is ∞ long"
usecase ampHash as "this is also &#8734; long"
usecase angleBrackets as "this is also <U+221E> long"
@enduml

```

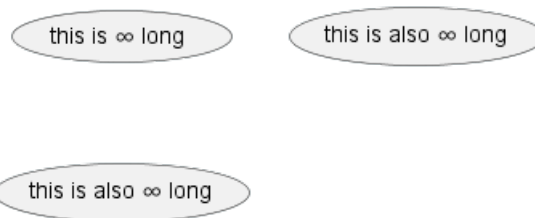

Please note that not all Unicode chars appear correctly, depending on what fonts are installed (on your local system or the PlantUML server, depending on which one you use). For characters that are emoji, it's better to use the [Emoji](<https://plantuml.com/creole#68305e25f5788db0>) notation. See [Issue 72](<https://github.com/plantuml/plantuml/issues/72>) for more details.

22.12 Tag HTML

Certains tag HTML sont encore fonctionnels:

- `` pour du texte en gras
- `<u>` ou `<u:#AAAAAA>` ou `<u:[[color|colorName]]>` pour souligner
- `<i>` pour de l'italique
- `<s>` ou `<s:#AAAAAA>` ou `<s:[[color|colorName]]>` pour barrer du texte
- `<w>` ou `<w:#AAAAAA>` ou `<w:[[color|colorName]]>` pour souligner en vague



- `<color:#AAAAAA>` ou `<color:[[color|colorName]]>` pour la couleur
- `<back:#AAAAAA>` ou `<back:[[color|colorName]]>` pour la couleur de fond
- `<size:nn>` pour changer la taille des caractères
- `<img:file>` : le fichier doit être accessible sur le système de fichier
- `<img:http://plantuml.com/logo3.png>` : l'URL doit être accessible

```
@startuml
:* You can change <color:red>text color</color>
* You can change <back:cadetblue>background color</back>
* You can change <size:18>size</size>
* You use <u>legacy</u> <b>HTML <i>tag</i></b>
* You use <u:red>color</u> <s:green>in HTML</s> <w:#0000FF>tag</w>
----
* Use image : <img:http://plantuml.com/logo3.png>
;
@enduml
```



22.12.1 Common HTML element

```
@startuml
hide footbox
note over Source
<code>
  This is <b>bold</b>
  This is <i>italics</i>
  This is <font:monospaced>monospaced</font>
  This is <s>stroked</s>
  This is <u>underlined</u>
  This is <w>waved</w>
  This is <s:green>stroked</s>
  This is <u:red>underlined</u>
  This is <w:#0000FF>waved</w>
  -- other examples --
  This is <color:blue>Blue</color>
  This is <back:orange>Orange background</back>
  This is <size:20>big</size>
</code>
end note
/note over Output
  This is <b>bold</b>
  This is <i>italics</i>
```



```

This is <font:monospaced>monospaced</font>
This is <s>stroked</s>
This is <u>underlined</u>
This is <w>waved</w>
This is <s:green>stroked</s>
This is <u:red>underlined</u>
This is <w:#0000FF>waved</w>
-- other examples --
This is <color:blue>Blue</color>
This is <back:orange>Orange background</back>
This is <size:20>big</size>
end note
@enduml

```

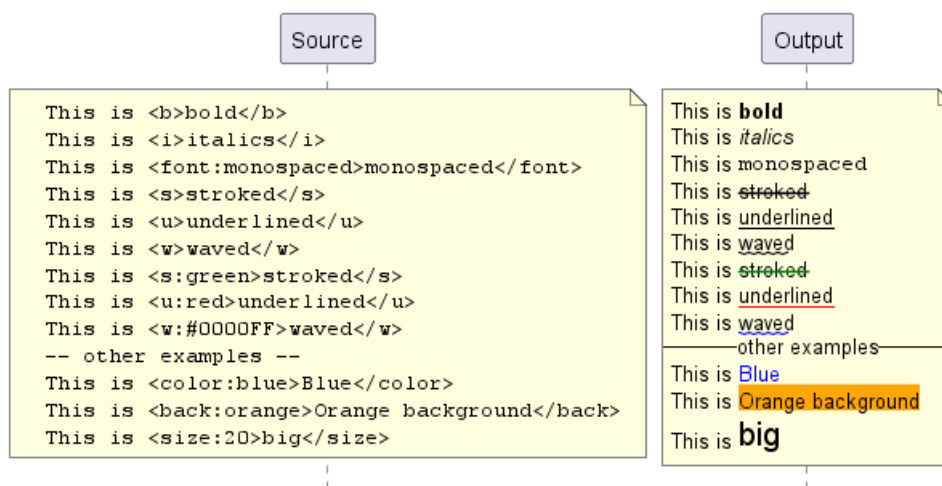

22.12.2 Subscript and Superscript element [sub, sup]

```

@startuml
: <code>
This is the "caffeine" molecule: C<sub>8</sub>H<sub>10</sub>N<sub>4</sub>O<sub>2</sub>
</code>
This is the "caffeine" molecule: C<sub>8</sub>H<sub>10</sub>N<sub>4</sub>O<sub>2</sub>
----
<code>
This is the Pythagorean theorem: a<sup>2</sup> + b<sup>2</sup> = c<sup>2</sup>
</code>
This is the Pythagorean theorem: a<sup>2</sup> + b<sup>2</sup> = c<sup>2</sup>;
@enduml

```

<pre> This is the "caffeine" molecule: C<sub>8</sub>H<sub>10</sub>N<sub>4</sub>O<sub>2</sub> This is the "caffeine" molecule: C₈H₁₀N₄O₂ </pre>
<pre> This is the Pythagorean theorem: a<sup>2</sup> + b<sup>2</sup> = c<sup>2</sup> This is the Pythagorean theorem: a² + b² = c² </pre>

22.13 OpenIconic

OpenIconic est un jeu d'icônes open-source très agréable. Ces icônes sont intégrées dans l'analyseur créole, vous pouvez donc les utiliser directement.

Utilisez la syntaxe suivante `<&ICON_NAME>`

```

@startuml
title: <size:20>&heart>Use of OpenIconic</size>

```



```
class Wifi
note left
  Click on <&wifi>
end note
@enduml
```

♥Use of OpenIconic♥



La liste complète est disponible sur le site web d'OpenIconic, ou vous pouvez utiliser la commande spéciale suivante pour les lister

```
@startuml
listopeniconic
@enduml
```

List Open Iconic

Credit to
<https://useiconic.com/open>

☰ account-login	🔔 bell	☁ cloud	☰ excerpt	☰ justify-right	🎵 musical-note	★ star
☰ account-logout	📶 bluetooth	☁ cloudy	☰ expand-down	🔑 key	📄 paperclip	☀ sun
↶ action-redo	🔩 bolt	📄 code	☰ expand-left	💻 laptop	✍ pencil	📱 tablet
↷ action-undo	📖 book	⚙ cog	☰ expand-right	📂 layers	👤 people	🏷 tag
☰ align-center	🔖 bookmark	☰ collapse-down	☰ expand-up	💡 lightbulb	👤 person	🏷 tags
☰ align-left	📦 box	☰ collapse-left	🔗 external-link	🔗 link-broken	📱 phone	🎯 target
☰ align-right	📁 briefcase	☰ collapse-right	👁 eye	🔗 link-intact	📱 pie-chart	📁 task
🔍 aperture	🇬🇧 british-pound	☰ collapse-up	👉 eyedropper	📋 list-rich	📌 pin	🖨 terminal
↓ arrow-bottom	🗂 browser	⌘ command	📁 file	☰ list	🎮 play-circle	📄 text
🕒 arrow-circle-bottom	🖱 brush	📐 comment-square	🔥 fire	📍 location	➕ plus	👇 thumb-down
🕒 arrow-circle-left	🐛 bug	📏 compass	🚩 flag	🔒 lock-locked	🕒 power-standby	👍 thumb-up
🕒 arrow-circle-right	📣 bullhorn	© copyright	⚡ flash	🔓 lock-unlocked	🖨 print	⌚ timer
🕒 arrow-circle-top	📊 calculator	© copywriting	📁 folder	🔄 loop-circular	📁 project	🔄 transfer
← arrow-left	📅 calendar	💳 credit-card	🔗 fork	☰ loop-square	➕ pulse	🗑 trash
→ arrow-right	📷 camera-slr	🗂 crop	🖱 fullscreen-enter	☰ loop	🧩 puzzle-piece	📁 underline
↓ arrow-thick-bottom	📏 caret-bottom	📊 dashboard	🖱 fullscreen-exit	🔍 magnifying-glass	? question-mark	📁 vertical-align-bottom
← arrow-thick-left	⏪ caret-left	⬇ data-transfer-download	🌐 globe	📍 map-marker	🌧 rain	📁 vertical-align-center
→ arrow-thick-right	⏩ caret-right	↕ data-transfer-upload	📊 graph	📍 map	✳ random	📁 vertical-align-top
↑ arrow-thick-top	⬆ caret-top	🗑 delete	📊 grid-four-up	⏸ media-pause	🔄 reload	📁 video
↶ arrow-top	🗑 cart	📞 dial	📊 grid-three-up	▶ media-play	↕ resize-both	🔊 volume-high
📊 audio-spectrum	💬 chat	📄 document	📊 grid-two-up	📄 media-record	↕ resize-height	🔊 volume-low
🔊 audio	✓ check	💰 dollar	📁 hard-drive	⏮ media-skip-backward	↔ resize-width	🔊 volume-off
📌 badge	📄 chevron-bottom	” double-quote-sans-left	📁 header	▶ media-skip-forward	📡 rss-alt	⚠ warning
📊 bar-chart	📄 chevron-left	” double-quote-sans-right	📁 headphones	⏪ media-step-backward	📡 rss	📶 wifi
🔋 battery-empty	📄 chevron-right	” double-quote-serif-left	♥ heart	▶ media-step-forward	📄 script	✂ wrench
🔋 battery-full	📄 chevron-top	” double-quote-serif-right	🏠 home	⏹ media-stop	📄 share-boxed	✂ x
🧪 beaker	📄 cloud-download	💧 droplet	🖼 image	🏥 medical-cross	📄 share	¥ yen
	📄 circle-check	📄 eject	📁 inbox	☰ menu	🛡 shield	🔍 zoom-in
	📄 circle-x	📄 elevator	∞ infinity	🎤 microphone	📶 signal	🔍 zoom-out
	📄 clipboard	” ellipses	📄 info	➖ minus	📌 signpost	
	🕒 clock	✉ envelope-closed	📄 italic	📱 monitor	📈 sort-ascending	
	☁ cloud-download	✉ envelope-open	☰ justify-center	🌙 moon	📈 sort-descending	
	☁ cloud-upload	€ euro	☰ justify-left	➡ move	📊 spreadsheet	

22.14 Annexe : Exemples de "liste créée" sur tous les diagrammes

22.14.1 Activité

```
@startuml
start
:**test list 1**
* Bullet list
* Second item
** Sub item
*** Sub sub item
* Third item
----
:**test list 2**
# Numbered list
# Second item
```



```

## Sub item
## Another sub item
# Third item;
stop
@enduml

```

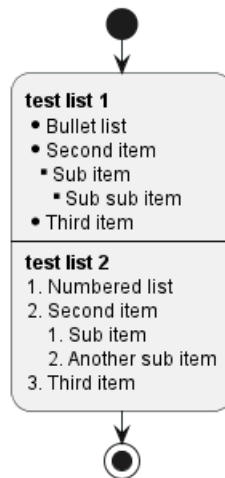

22.14.2 Classe

TODO: FIXME

- *Sous-élément*
- *Sous-élément*

TODO: FIXME

```
@startuml
```

```

class a {
**test list 1**
* Bullet list
* Second item
** Sub item
*** Sub sub item
* Third item
----
**test list 2**
# Numbered list
# Second item
## Sub item
## Another sub item
# Third item
}

```

```
a -- b
```

```
@enduml
```



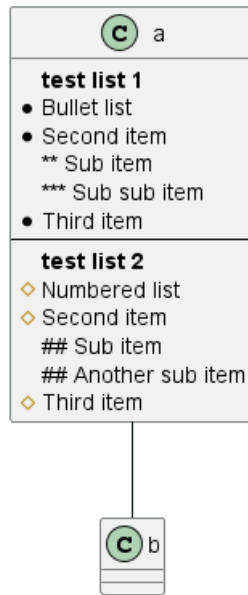

22.14.3 Composant, Déploiement, Cas d'utilisation

```

@startuml
node n [
**test list 1**
* Bullet list
* Second item
** Sub item
*** Sub sub item
* Third item
----
**test list 2**
# Numbered list
# Second item
## Sub item
## Another sub item
# Third item
]

file f as "
**test list 1**
* Bullet list
* Second item
** Sub item
*** Sub sub item
* Third item
----
**test list 2**
# Numbered list
# Second item
## Sub item
## Another sub item
# Third item
"
@enduml

```



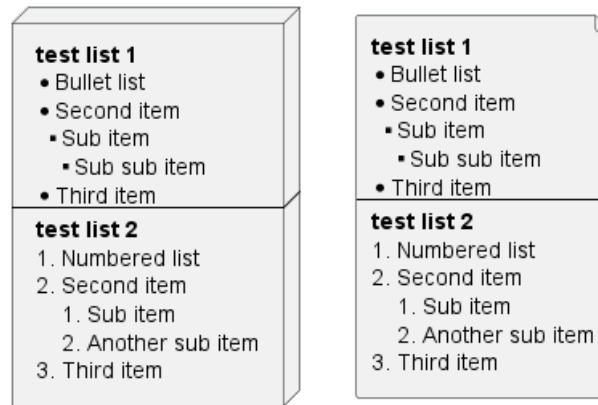

TODO: DONE [Corrigé dans la V1.2020.18]

22.14.4 Planification de projet Gantt

N/A

22.14.5 Object

TODO: FIXME

- *Sous-élément*
- *Sous-élément*

TODO: FIXME

```
@startuml
object user {
**test list 1**
* Bullet list
* Second item
** Sub item
*** Sub sub item
* Third item
----
**test list 2**
# Numbered list
# Second item
## Sub item
## Another sub item
# Third item
}
@enduml
```

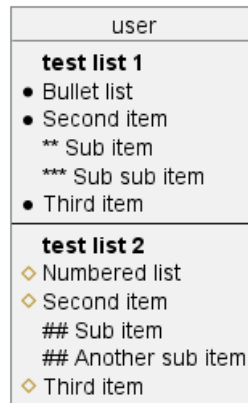

22.14.6 MindMap

```

@startmindmap

* root
** d1
**:**test list 1**
* Bullet list
* Second item
** Sub item
*** Sub sub item
* Third item
----
**test list 2**
# Numbered list
# Second item
## Sub item
## Another sub item
# Third item;

@endmindmap

```

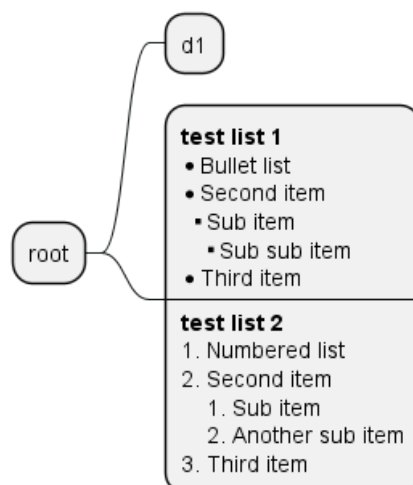

22.14.7 Réseau (nwdiag)

N/A



22.14.8 Note

```

@startuml
note as n
**test list 1**
* Bullet list
* Second item
** Sub item
*** Sub sub item
* Third item
----
**test list 2**
# Numbered list
# Second item
## Sub item
## Another sub item
# Third item
end note
@enduml

```

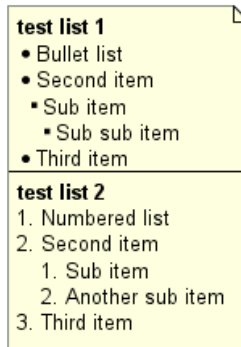

22.14.9 Sequence

N/A (ou sur note ou commandes communes)

22.14.10 State

N/A (ou sur note ou commandes communes)

22.15 Annexe : Exemples de "lignes horizontales créoles" sur tous les diagrammes

22.15.1 Activité

TODO: FIXME ligne forte ____ **TODO: FIXME**

```

@startuml
start
:You can have horizontal line
----
Or double line
====
Or strong line
-----
Or dotted line
..My title..
Or dotted title
//and title... //
==Title==

```



```

Or double-line title
--Another title--
Or single-line title
Enjoy!;
stop
@enduml

```

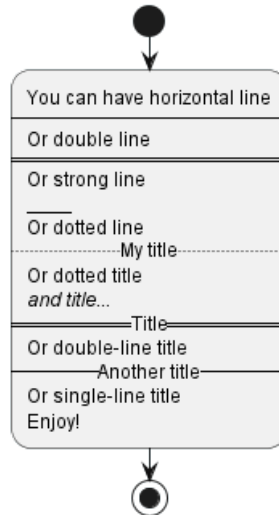

22.15.2 Classe

```

@startuml

class a {
You can have horizontal line
----
Or double line
====
Or strong line
----
Or dotted line
..My title..
Or dotted title
//and title... //
==Title==
Or double-line title
--Another title--
Or single-line title
Enjoy!
}

a -- b

@enduml

```



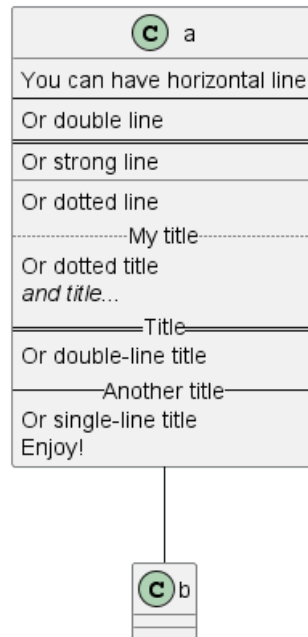

22.15.3 Composant, déploiement, cas d'utilisation

```

@startuml
node n [
You can have horizontal line
----
Or double line
====
Or strong line
-----
Or dotted line
..My title..
//and title... //
==Title==
--Another title--
Enjoy!
]

file f as "
You can have horizontal line
----
Or double line
====
Or strong line
-----
Or dotted line
..My title..
//and title... //
==Title==
--Another title--
Enjoy!
"
@enduml

```



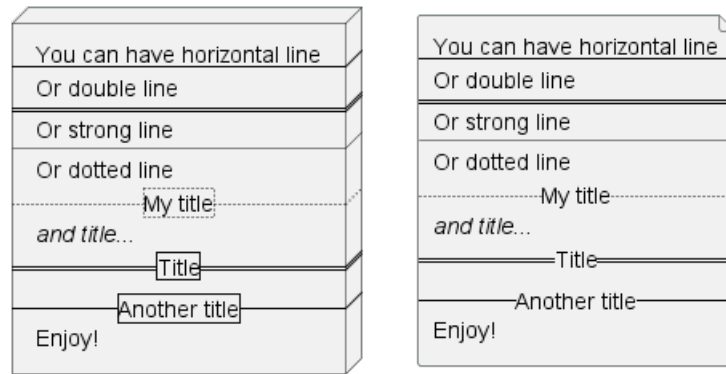

22.15.4 Planification de projet Gantt

N/A

22.15.5 Objet

```
@startuml
object user {
You can have horizontal line
----
Or double line
====
Or strong line
----
Or dotted line
..My title..
//and title... //
==Title==
--Another title--
Enjoy!
}

@enduml
```

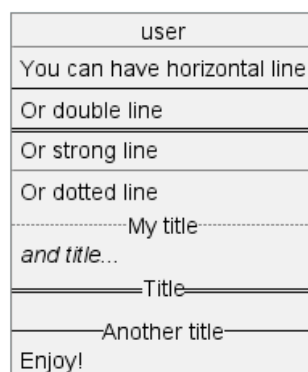

TODO: DONE [Corrected on V1.2020.18]

22.15.6 MindMap

TODO: FIXME strong line ____ **TODO:** FIXME

```
@startmindmap
```

```
* root
```



```

** d1
**:You can have horizontal line
----
Or double line
====
Or strong line
----
Or dotted line
..My title..
//and title... //
==Title==
--Another title--
Enjoy!;

@endmindmap

```

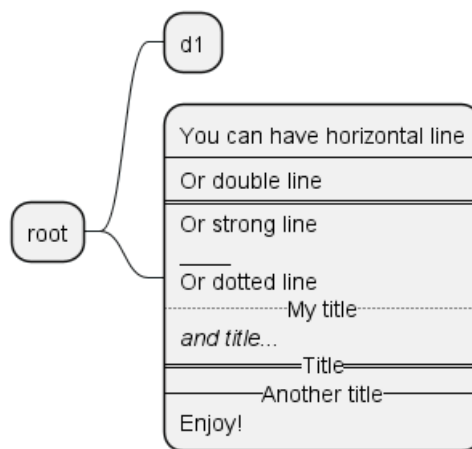

22.15.7 Réseau (nwdiag)

N/A

22.15.8 Note

```

@startuml
note as n
You can have horizontal line
----
Or double line
====
Or strong line
----
Or dotted line
..My title..
//and title... //
==Title==
--Another title--
Enjoy!
end note
@enduml

```



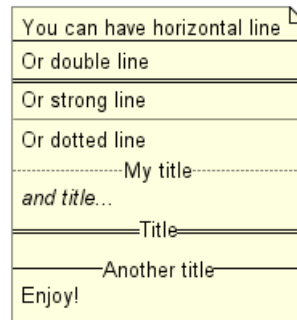

22.15.9 Sequence

N/A (ou sur note ou commandes communes)

22.15.10 State

N/A (ou sur note ou commandes communes)

22.16 Équivalence de style (entre le créole et le HTML)

Style	Créole	Legacy HTML comme
gras	C'est **bold**	C'est <code>bold</code>
italique	C'est <code>//italics//</code>	C'est <code><i>italics</i></code>
monospaced	C'est <code>"monospaced"</code>	C'est <code><font:monospaced>monospaced</code>
stroké	C'est <code>--stroked--</code>	C'est <code><s>stroked</s></code>
souligné	C'est <code>__underlined__</code>	C'est <code><u>underlined</u></code>
agité	C'est <code>~~~</code>	C'est <code><w>waved</w></code>

@startmindmap

* Style equivalent\n(between Creole and HTML)

:Creole**

<#silver>|= code|= output|

```
| \n This is ""~**bold**""\n | \n This is bold |
| \n This is ""~//italics//""\n | \n This is italics |
| \n This is ""~"monospaced~"" ""\n | \n This is "monospaced" |
| \n This is ""~--stroked--""\n | \n This is --stroked-- |
| \n This is ""~__underlined__""\n | \n This is __underlined__ |
| \n This is ""<U+007E><U+007E>waved<U+007E><U+007E>""\n | \n This is ~waved~ |;
```

**:Legacy HTML like

<#silver>|= code|= output|

```
| \n This is ""~<b>bold</b>""\n | \n This is <b>bold</b> |
| \n This is ""~<i>italics</i>""\n | \n This is <i>italics</i> |
| \n This is ""~<font:monospaced>monospaced</font>""\n | \n This is <font:monospaced>monospaced</font> |
| \n This is ""~<s>stroked</s>""\n | \n This is <s>stroked</s> |
| \n This is ""~<u>underlined</u>""\n | \n This is <u>underlined</u> |
| \n This is ""~<w>waved</w>""\n | \n This is <w>waved</w> |
```

And color as a bonus...

<#silver>|= code|= output|

```
| \n This is ""~<s:""<color:green>"green"</color>"">stroked</s>""\n | \n This is <s:green>stroked</s> |
| \n This is ""~<u:""<color:red>"red"</color>"">underlined</u>""\n | \n This is <u:red>underlined</u> |
| \n This is ""~<w:""<color:#0000FF>"#0000FF"</color>"">waved</w>""\n | \n This is <w:#0000FF>waved</w> |
```

@endmindmap



Style équivalent
(between Creole and HTML)

Creole	
code	output
This is **bold**	This is bold
This is <i>//italics//</i>	This is <i>italics</i>
This is <code>""monospaced""</code>	This is monospaced
This is --stroked--	This is stroked
This is <u>__underlined__</u>	This is <u>underlined</u>
This is <u>~~waved~~</u>	This is <u>waved</u>

Legacy HTML like	
code	output
This is <code>bold</code>	This is bold
This is <code><i>italics</i></code>	This is <i>italics</i>
This is <code><font:monospaced>monospaced</code>	This is monospaced
This is <code><s>stroked</s></code>	This is stroked
This is <code><u>underlined</u></code>	This is <u>underlined</u>
This is <code><w>waved</w></code>	This is <u>waved</u>

And color as a bonus...

code	output
This is <code><s:green>stroked</s></code>	This is stroked
This is <code><u:red>underlined</u></code>	This is <u>underlined</u>
This is <code><w:#0000FF>waved</w></code>	This is <u>waved</u>



23 Defining and using sprites

A *Sprite* is a small graphic element that can be used in diagrams.

In PlantUML, sprites are monochrome and can have either 4, 8 or 16 gray level.

To define a sprite, you have to use a hexadecimal digit between 0 and F per pixel.

Then you can use the sprite using <\$XXX> where XXX is the name of the sprite.

```
@startuml
sprite $foo1 {
  FFFFFFFFFFFFFFFF
  F0123456789ABCF
  F0123456789ABCF
  F0123456789ABCF
  F0123456789ABCF
  F0123456789ABCF
  F0123456789ABCF
  F0123456789ABCF
  F0123456789ABCF
  F0123456789ABCF
  F0123456789ABCF
  FFFFFFFFFFFFFFFF
}
Alice -> Bob : Testing <$foo1>
@enduml
```

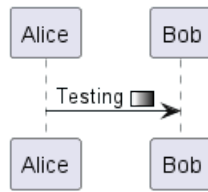

You can scale the sprite.

```
@startuml
sprite $foo1 {
  FFFFFFFFFFFFFFFF
  F0123456789ABCF
  F0123456789ABCF
  F0123456789ABCF
  F0123456789ABCF
  F0123456789ABCF
  F0123456789ABCF
  F0123456789ABCF
  F0123456789ABCF
  F0123456789ABCF
  FFFFFFFFFFFFFFFF
}
Alice -> Bob : Testing <$foo1{scale=3}>
@enduml
```

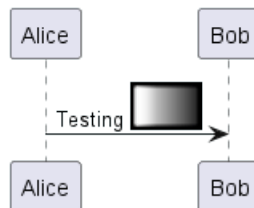

23.1 Inline SVG sprite

You can also use inlined SVG for sprites. Only a tiny subset of SVG directives is possible, so you probably have to compress existing SVG files using <https://vecta.io/nano>.

```
@startuml
sprite foo1 <svg width="8" height="8" viewBox="0 0 8 8"><path d="M1 0l-1 1 1.5 1.5-1.5 1.5h4v-4l-1.5
Alice->Bob : <$foo1*3>
@enduml
```

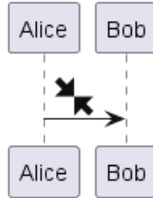

Another example:

```
@startuml
sprite foo1 <svg viewBox="0 0 36 36">
<path fill="#77B255" d="M36 32c0 2.209-1.791 4-4 4H4c-2.209 0-4-1.791-4-4V4c0-2.209 1.791-4 4-4h28c2
<path fill="#FFF" d="M21.529 18.006l8.238-8.238c.977-.976.977-2.559 0-3.535-.977-.977-2.559-.977-3.535
</svg>
Alice->Bob : <$foo1>
@enduml
```

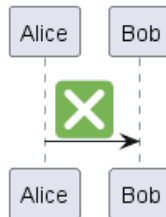

23.2 Changing colors

Although sprites are monochrome, it's possible to change their color.

```
@startuml
sprite $foo1 {
FFFFFFFFFFFFFFFF
F0123456789ABCF
F0123456789ABCF
F0123456789ABCF
F0123456789ABCF
F0123456789ABCF
F0123456789ABCF
F0123456789ABCF
F0123456789ABCF
F0123456789ABCF
FFFFFFFFFFFFFFFF
}
Alice -> Bob : Testing <$foo1,scale=3.4,color=orange>
@enduml
```



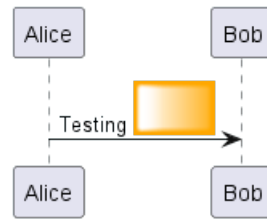

23.3 Encoding Sprite

To encode sprite, you can use the command line like:

```
java -jar plantuml.jar -encodesprite 16z foo.png
```

where `foo.png` is the image file you want to use (it will be converted to gray automatically).

After `-encodesprite`, you have to specify a format: `4`, `8`, `16`, `4z`, `8z` or `16z`.

The number indicates the gray level and the optional `z` is used to enable compression in sprite definition.

23.4 Importing Sprite

You can also launch the GUI to generate a sprite from an existing image.

Click in the menubar then on `File/Open Sprite Window`.

After copying an image into you clipboard, several possible definitions of the corresponding sprite will be displayed : you will just have to pickup the one you want.

23.5 Examples

```
@startuml
sprite $printer [15x15/8z] N0tH3W0W208HxFz_kMAhj7lHWpa1XC716sz0Pq4MVPEWfBHIuxP3L6kbTcizR8tAhzaqFvXwv
start
:click on <$printer> to print the page;
@enduml
```



```
@startuml
sprite $bug [15x15/16z] PKzR2i0m2BFMi15p__FEjQEgB1z27aeqCqixa8S40T7C53cKpsHpaYPDJY_12MHM-BLRyywPhrr
sprite $printer [15x15/8z] N0tH3W0W208HxFz_kMAhj7lHWpa1XC716sz0Pq4MVPEWfBHIuxP3L6kbTcizR8tAhzaqFvXwv
sprite $disk {
  444445566677881
  43600000009991
  4360000000ACA1
  5370000001A7A1
  53700000012B8A1
  53800000123B8A1
  63800001233C9A1
  634999AABBC99B1
  744566778899AB1
  7456AAAAA99AAB1
  8566AFC228AABB1
  8567AC8118BBBB1
  867BD4433BBBBB1
  39AAAAABBBBBBC1
}
}
```

```

title Use of sprites (<$printer>, <$bug>...)

class Example {
Can have some bug : <$bug>
Click on <$disk> to save
}

note left : The printer <$printer> is available

@enduml

```



23.6 StdLib

The PlantUML StdLib includes a number of ready icons in various IT areas such as architecture, cloud services, logos etc. It including AWS, Azure, Kubernetes, C4, product Logos and many others. To explore these libraries:

- Browse the Github folders of PlantUML StdLib
- Browse the source repos of StdLib collections that interest you. Eg if you are interested in logos you can find that it came from gilbarbara-plantuml-sprites, and quickly find its

sprites-list. (The next section shows how to list selected sprites but unfortunately that's in grayscale whereas this custom listing is in color.)

- Study the in-depth Hitchhiker' s Guide to PlantUML, eg sections Standard Library Sprites and PlantUML Stdlib Overview

23.7 Listing Sprites

You can use the `listsprites` command to show available sprites:

- Used on its own, it just shows ArchiMate sprites
- If you include some sprite libraries in your diagram, the command shows all these sprites, as explained in View all the icons with listsprites.

(Example from Hitchhikers Guide to PlantUML)

```

@startuml
!define osaPuml https://raw.githubusercontent.com/Crashedmind/PlantUML-opensecurityarchitecture2-ico
!include osaPuml/Common.puml
!include osaPuml/User/all.puml
!include osaPuml/Hardware/all.puml
!include osaPuml/Misc/all.puml
!include osaPuml/Server/all.puml
!include osaPuml/Site/all.puml

listsprites

' From The Hitchhiker' s Guide to PlantUML
@enduml

```





Most collections have files called `all` that allow you to see a whole sub-collection at once. Else you need to find the sprites that interest you and include them one by one. Unfortunately, the version of a collection included in `StdLib` often does not have such `all` files, so as you see above we include the collection from `github`, not from `StdLib`.

All sprites are in grayscale, but most collections define specific macros that include appropriate (vendor-specific) colors.



24 Skinparam command

You can change colors and font of the drawing using the `skinparam` command.

Example:

```
skinparam backgroundColor transparent
```

24.1 Usage

You can use this command :

- In the diagram definition, like any other commands,
- In an included file,
- In a configuration file, provided in the command line or the ANT task.

24.2 Nested

To avoid repetition, it is possible to nest definition. So the following definition :

```
skinparam xxxxParam1 value1
skinparam xxxxParam2 value2
skinparam xxxxParam3 value3
skinparam xxxxParam4 value4
```

is strictly equivalent to:

```
skinparam xxxx {
    Param1 value1
    Param2 value2
    Param3 value3
    Param4 value4
}
```

24.3 Black and White

You can force the use of a black&white output using `skinparam monochrome true` command.

```
@startuml

skinparam monochrome true

actor User
participant "First Class" as A
participant "Second Class" as B
participant "Last Class" as C

User -> A: DoWork
activate A

A -> B: Create Request
activate B

B -> C: DoWork
activate C
C --> B: WorkDone
destroy C

B --> A: Request Created
deactivate B
```



```

A --> User: Done
deactivate A

@enduml

```

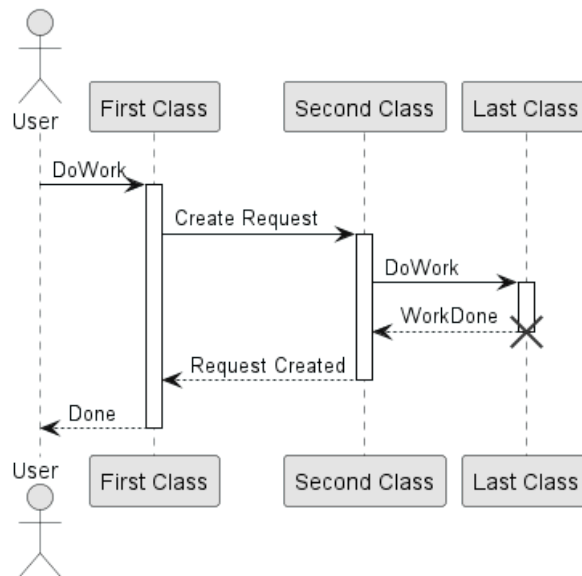

24.4 Shadowing

You can disable the shadowing using the `skinparam shadowing false` command.

```

@startuml

left to right direction

skinparam shadowing<<no_shadow>> false
skinparam shadowing<<with_shadow>> true

actor User
(Glowing use case) <<with_shadow>> as guc
(Flat use case) <<no_shadow>> as fuc
User -- guc
User -- fuc

@enduml

```

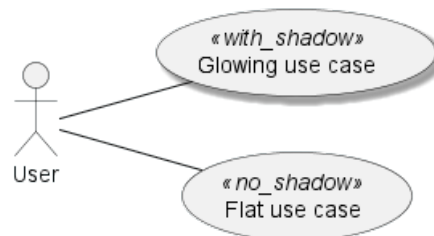

24.5 Reverse colors

You can force the use of a black&white output using `skinparam monochrome reverse` command. This can be useful for black background environment.

```

@startuml

skinparam monochrome reverse

```



```

actor User
participant "First Class" as A
participant "Second Class" as B
participant "Last Class" as C

User -> A: DoWork
activate A

A -> B: Create Request
activate B

B -> C: DoWork
activate C
C --> B: WorkDone
destroy C

B --> A: Request Created
deactivate B

A --> User: Done
deactivate A

@enduml

```

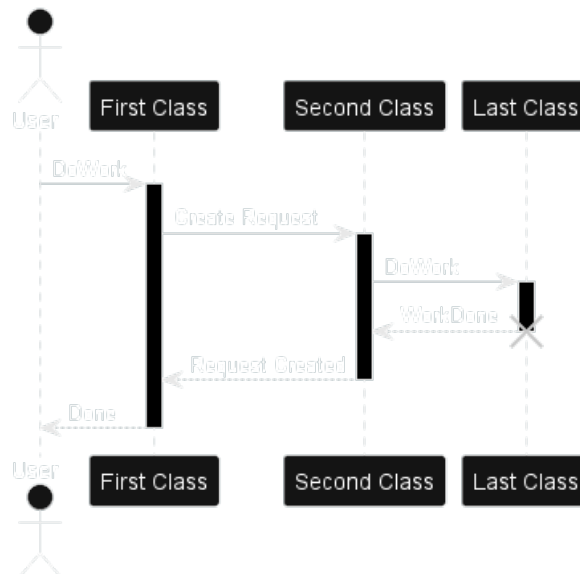

24.6 Colors

You can use either standard color name or RGB code.

```

@startuml
colors
@enduml

```

APPLICATION	Crimson	DeepPink	Indigo	LightYellow	Navy	RoyalBlue	Turquoise
AliceBlue	Cyan	DeepSkyBlue	Ivory	Lime	OldLace	STRATEGY	Violet
AntiqueWhite	DarkBlue	DimGray	Khaki	LimeGreen	Olive	SaddleBrown	Wheat
Aqua	DarkCyan	DimGrey	Lavender	Linen	OliveDrab	Salmon	White
Aquamarine	DarkGoldenRod	DodgerBlue	LavenderBlush	MOTIVATION	Orange	SandyBrown	WhiteSmoke
Azure	DarkGray	FireBrick	LawnGreen	Magenta	OrangeRed	SeaGreen	Yellow
BUSINESS	DarkGreen	FloralWhite	LemonChiffon	Maroon	Orchid	SeaShell	YellowGreen
Beige	DarkGrey	ForestGreen	LightBlue	MediumAquaMarine	PHYSICAL	Sienna	
Bisque	DarkKhaki	Fuchsia	LightCoral	MediumBlue	PaleGoldenRod	Silver	
Black	DarkMagenta	Gainsboro	LightCyan	MediumOrchid	PaleGreen	SkyBlue	
BlanchedAlmond	DarkOliveGreen	GhostWhite	LightGoldenRodYellow	MediumPurple	PaleTurquoise	SlateBlue	
Blue	DarkOrchid	Gold	LightGray	MediumSeaGreen	PaleVioletRed	SlateGray	
BlueViolet	DarkRed	GoldenRod	LightGreen	MediumSlateBlue	PapayaWhip	SlateGrey	
Brown	DarkSalmon	Gray	LightGrey	MediumSpringGreen	PeachPuff	Snow	
BurlyWood	DarkSeaGreen	Green	LightPink	MediumTurquoise	Peru	SpringGreen	
CadetBlue	DarkSlateBlue	GreenYellow	LightSalmon	MediumVioletRed	Pink	SteelBlue	
Chartreuse	DarkSlateGray	Grey	LightSeaGreen	MidnightBlue	Plum	TECHNOLOGY	
Chocolate	DarkSlateGrey	HoneyDew	LightSkyBlue	MintCream	PowderBlue	Tan	
Coral	DarkTurquoise	HotPink	LightSlateGray	MistyRose	Purple	Teal	
CornflowerBlue	DarkViolet	IMPLEMENTATION	LightSlateGrey	Moccasin	Red	Thistle	
Cornsilk	Darkorange	IndianRed	LightSteelBlue	NavajoWhite	RosyBrown	Tomato	

transparent can only be used for background of the image.

24.7 Font color, name and size

You can change the font for the drawing using `xxxFontColor`, `xxxFontSize` and `xxxFontName` parameters.

Example:

```
skinparam classFontColor red
skinparam classFontSize 10
skinparam classFontName Aapex
```

You can also change the default font for all fonts using `skinparam defaultFontName`.

Example:

```
skinparam defaultFontName Aapex
```

Please note the fontname is highly system dependent, so do not over use it, if you look for portability. Helvetica and Courier should be available on all systems.

A lot of parameters are available. You can list them using the following command:

```
java -jar plantuml.jar -language
```

24.8 Text Alignment

Text alignment can be set to `left`, `right` or `center` in `skinparam sequenceMessageAlign`. You can also use `direction` or `reverseDirection` values to align text depending on arrow direction.

Param name	Default value	Comment
<code>sequenceMessageAlign</code>	<code>left</code>	Used for messages in sequence diagrams
<code>sequenceReferenceAlign</code>	<code>center</code>	Used for <code>ref over</code> in sequence diagrams

```
@startuml
skinparam sequenceMessageAlign center
Alice -> Bob : Hi
Bob -> Alice : This is very long
@enduml
```



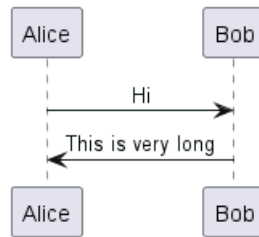

```

@startuml
skinparam sequenceMessageAlign right
Alice -> Bob : Hi
Bob -> Alice : This is very long
@enduml
  
```

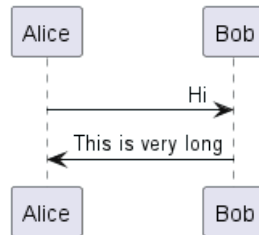

```

@startuml
skinparam sequenceMessageAlign direction
Alice -> Bob : Hi
Bob -> Alice: Hi
@enduml
  
```

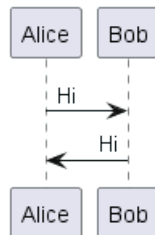

24.9 Examples

```

@startuml
skinparam backgroundColor #EEEEDC
skinparam handwritten true

skinparam sequence {
ArrowColor DeepSkyBlue
ActorBorderColor DeepSkyBlue
LifeLineBorderColor blue
LifeLineBackgroundColor #A9DCDF

ParticipantBorderColor DeepSkyBlue
ParticipantBackgroundColor DodgerBlue
ParticipantFontName Impact
ParticipantFontSize 17
ParticipantFontColor #A9DCDF

ActorBackgroundColor aqua
ActorFontColor DeepSkyBlue
ActorFontSize 17
ActorFontName Apex
  
```



```

}

actor User
participant "First Class" as A
participant "Second Class" as B
participant "Last Class" as C

User -> A: DoWork
activate A

A -> B: Create Request
activate B

B -> C: DoWork
activate C
C --> B: WorkDone
destroy C

B --> A: Request Created
deactivate B

A --> User: Done
deactivate A
@enduml

```

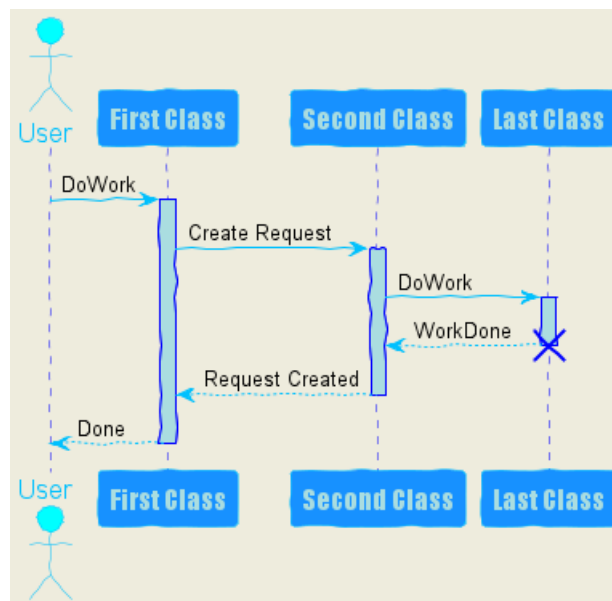

```

@startuml
skinparam handwritten true

skinparam actor {
  BorderColor black
  FontName Courier
  BackgroundColor<< Human >> Gold
}

skinparam usecase {
  BackgroundColor DarkSeaGreen
  BorderColor DarkSlateGray
}

BackgroundColor<< Main >> YellowGreen

```



```

BorderColor<< Main >> YellowGreen

ArrowColor Olive
}

User << Human >>
:Main Database: as MySql << Application >>
(Start) << One Shot >>
(Use the application) as (Use) << Main >>

User -> (Start)
User --> (Use)

MySql --> (Use)
@enduml

```

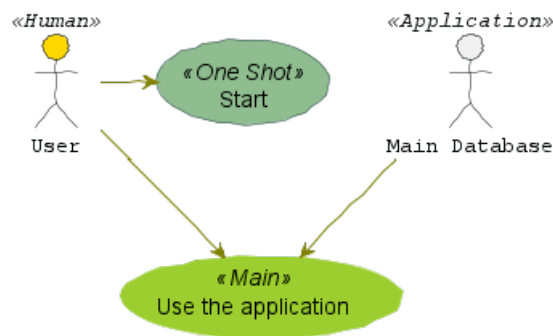

```

@startuml
skinparam roundcorner 20
skinparam class {
BackgroundColor PaleGreen
ArrowColor SeaGreen
BorderColor SpringGreen
}
skinparam stereotypeCBackgroundColor YellowGreen

```

```
Class01 "1" *-- "many" Class02 : contains
```

```
Class03 o-- Class04 : aggregation
@enduml
```

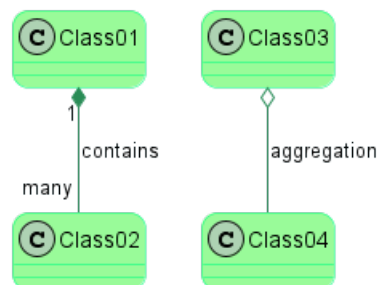

```

@startuml
skinparam interface {
backgroundColor RosyBrown
borderColor orange
}

```

```
skinparam component {
FontSize 13

```



```

BackgroundColor<<Apache>> LightCoral
BorderColor<<Apache>> #FF6655
FontName Courier
BorderColor black
BackgroundColor gold
ArrowFontName Impact
ArrowColor #FF6655
ArrowFontColor #777777
}

```

```

() "Data Access" as DA
[Web Server] << Apache >>

```

```

DA - [First Component]
[First Component] ..> () HTTP : use
HTTP - [Web Server]
@enduml

```

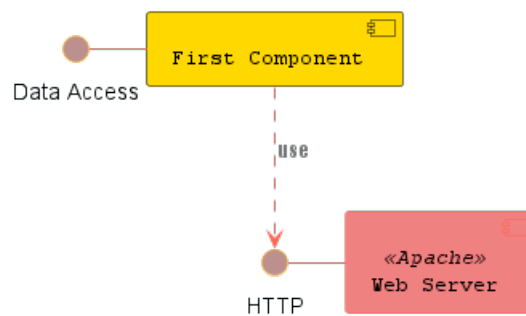

```

@startuml
[AA] <<static lib>>
[BB] <<shared lib>>
[CC] <<static lib>>

node node1
node node2 <<shared node>>
database Production

skinparam component {
    backgroundColor<<static lib>> DarkKhaki
    backgroundColor<<shared lib>> Green
}

skinparam node {
    borderColor Green
    backgroundColor Yellow
    backgroundColor<<shared node>> Magenta
}
skinparam databaseBackgroundColor Aqua
@enduml

```

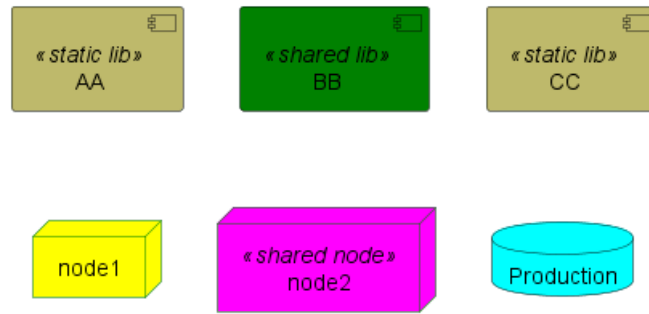

24.10 List of all skinparam parameters

You can use `-language` on the command line or generate a "diagram" with a list of all the skinparam parameters using :

- `help skinparams`
- `skinparameters`

24.10.1 Command Line: `-language` command

Since the documentation is not always up to date, you can have the complete list of parameters using this command:

```
java -jar plantuml.jar -language
```

24.10.2 Command: `help skinparams`

That will give you the following result, from this page (*code of this command*): `CommandHelpSkinparam.java`

```
@startuml
help skinparams
@enduml
```

Welcome to PlantUML!

You can start with a simple UML Diagram like:

```
Bob->Alice: Hello
```

Or

```
class Example
```

You will find more information about PlantUML syntax on <https://plantuml.com>

(Details by typing `license` keyword)



```
PlantUML 1.2023.11
```

```
[From string (line 2)]
```

```
@startuml
help skinparams
Syntax Error?
```

24.10.3 Command: `skinparameters`

```
@startuml
skinparameters
@enduml
```



ActivityBackgroundColor	ClassFontStyle	FolderStereoTypeFontSize	NoteFontStyle	SequenceDelayFontName
ActivityBorderColor	ClassStereoTypeFontColor	FolderStereoTypeFontStyle	NoteShadowing	SequenceDelayFontSize
ActivityBorderThickness	ClassStereoTypeFontName	FooterFontColor	NoteTextAlignment	SequenceDelayFontStyle
ActivityDiamondFontColor	ClassStereoTypeFontSize	FooterFontName	ObjectAttributeFontColor	SequenceDividerBorderThickness
ActivityDiamondFontName	ClassStereoTypeFontStyle	FooterFontSize	ObjectAttributeFontName	SequenceDividerFontColor
ActivityDiamondFontSize	CloudFontColor	FooterFontStyle	ObjectAttributeFontSize	SequenceDividerFontName
ActivityDiamondFontStyle	CloudFontName	FrameFontColor	ObjectAttributeFontStyle	SequenceDividerFontSize
ActivityFontColor	CloudFontSize	FrameFontName	ObjectBorderThickness	SequenceDividerFontStyle
ActivityFontName	CloudFontStyle	FrameFontSize	ObjectFontColor	SequenceGroupBodyBackgroundColor
ActivityFontSize	CloudStereoTypeFontColor	FrameFontStyle	ObjectFontName	SequenceGroupBorderThickness
ActivityFontStyle	CloudStereoTypeFontName	FrameStereoTypeFontColor	ObjectFontSize	SequenceGroupFontColor
ActorBackgroundColor	CloudStereoTypeFontSize	FrameStereoTypeFontName	ObjectFontStyle	SequenceGroupFontName
ActorBorderColor	CloudStereoTypeFontStyle	FrameStereoTypeFontSize	ObjectStereoTypeFontColor	SequenceGroupFontSize
ActorFontColor	ColorArrowSeparationSpace	FrameStereoTypeFontStyle	ObjectStereoTypeFontName	SequenceGroupFontStyle
ActorFontName	ComponentBorderThickness	GenericDisplay	ObjectStereoTypeFontSize	SequenceGroupHeaderFontColor
ActorFontSize	ComponentFontColor	Guillemet	ObjectStereoTypeFontStyle	SequenceGroupHeaderFontName
ActorFontStyle	ComponentFontName	Handwritten	PackageBorderThickness	SequenceGroupHeaderFontSize
ActorStereoTypeFontColor	ComponentFontSize	HeaderFontColor	PackageFontColor	SequenceGroupHeaderFontStyle
ActorStereoTypeFontName	ComponentFontStyle	HeaderFontName	PackageFontName	SequenceLifeLineBorderColor
ActorStereoTypeFontSize	ComponentStereoTypeFontColor	HeaderFontSize	PackageFontSize	SequenceLifeLineBorderThickness
ActorStereoTypeFontStyle	ComponentStereoTypeFontName	HeaderFontStyle	PackageFontStyle	SequenceMessageAlignment
AgentBorderThickness	ComponentStereoTypeFontSize	HexagonBorderThickness	PackageStereoTypeFontColor	SequenceMessageTextAlignment
AgentFontColor	ComponentStereoTypeFontStyle	HexagonFontColor	PackageStereoTypeFontName	SequenceNewpageSeparatorColor
AgentFontName	ComponentStyle	HexagonFontName	PackageStereoTypeFontSize	SequenceParticipant
AgentFontSize	ConditionEndStyle	HexagonFontSize	PackageStereoTypeFontStyle	SequenceParticipantBorderThickness
AgentFontStyle	ConditionStyle	HexagonFontStyle	PackageStyle	SequenceReferenceAlignment
AgentStereoTypeFontColor	ControlFontColor	HexagonStereoTypeFontColor	PackageTitleAlignment	SequenceReferenceBackgroundColor
AgentStereoTypeFontName	ControlFontName	HexagonStereoTypeFontName	Padding	SequenceReferenceBorderThickness
AgentStereoTypeFontSize	ControlFontSize	HexagonStereoTypeFontSize	PageBorderColor	SequenceReferenceColor
AgentStereoTypeFontStyle	ControlFontStyle	HexagonStereoTypeFontStyle	PageExternalColor	SequenceReferenceFontName
ArchimateBorderThickness	ControlStereoTypeFontColor	HyperlinkColor	PageMargin	SequenceReferenceFontSize
ArchimateFontColor	ControlStereoTypeFontName	HyperlinkUnderline	ParticipantFontColor	SequenceReferenceFontStyle
ArchimateFontName	ControlStereoTypeFontSize	IconEMandatoryColor	ParticipantFontName	SequenceReferenceHeaderBackgroundColor
ArchimateFontSize	ControlStereoTypeFontStyle	IconPackageBackgroundColor	ParticipantFontSize	SequenceStereoTypeFontColor
ArchimateFontStyle	DatabaseFontColor	IconPackageColor	ParticipantFontStyle	SequenceStereoTypeFontName
ArchimateStereoTypeFontColor	DatabaseFontName	IconPrivateBackgroundColor	ParticipantPadding	SequenceStereoTypeFontSize
ArchimateStereoTypeFontName	DatabaseFontSize	IconPrivateColor	ParticipantStereoTypeFontColor	SequenceStereoTypeFontStyle
ArchimateStereoTypeFontSize	DatabaseFontStyle	IconProtectedBackgroundColor	ParticipantStereoTypeFontName	Shadowing
ArchimateStereoTypeFontStyle	DatabaseStereoTypeFontColor	IconProtectedColor	ParticipantStereoTypeFontSize	StackFontColor
ArrowFontColor	DatabaseStereoTypeFontName	IconPublicBackgroundColor	ParticipantStereoTypeFontStyle	StackFontName
ArrowFontName	DatabaseStereoTypeFontSize	IconPublicColor	PartitionBorderThickness	StackFontSize
ArrowFontSize	DatabaseStereoTypeFontStyle	InterfaceFontColor	PartitionFontColor	StackFontStyle
ArrowFontStyle	DefaultFontColor	InterfaceFontName	PartitionFontName	StackStereoTypeFontColor
ArrowHeadColor	DefaultFontName	InterfaceFontSize	PartitionFontSize	StackStereoTypeFontName
ArrowLollipopColor	DefaultFontSize	InterfaceFontStyle	PartitionFontStyle	StackStereoTypeFontSize
ArrowMessageAlignment	DefaultFontStyle	InterfaceStereoTypeFontColor	PathHoverColor	StackStereoTypeFontStyle
ArrowThickness	DefaultMonoSpacedFontName	InterfaceStereoTypeFontName	PersonBorderThickness	StateAttributeFontColor
ArtifactFontColor	DefaultTextAlignment	InterfaceStereoTypeFontSize	PersonFontColor	StateAttributeFontName
ArtifactFontName	DesignedBackgroundColor	InterfaceStereoTypeFontStyle	PersonFontName	StateAttributeFontSize
ArtifactFontSize	DesignedBorderColor	LabelFontColor	PersonFontSize	StateAttributeFontStyle
ArtifactFontStyle	DesignedDomainBorderThickness	LabelFontName	PersonFontStyle	StateBorderColor
ArtifactStereoTypeFontColor	DesignedDomainFontColor	LabelFontSize	PersonStereoTypeFontColor	StateFontColor
ArtifactStereoTypeFontName	DesignedDomainFontName	LabelFontStyle	PersonStereoTypeFontName	StateFontName
ArtifactStereoTypeFontSize	DesignedDomainFontSize	LabelStereoTypeFontColor	PersonStereoTypeFontSize	StateFontSize
ArtifactStereoTypeFontStyle	DesignedDomainFontStyle	LabelStereoTypeFontName	PersonStereoTypeFontStyle	StateFontStyle
BackgroundColor	DesignedDomainStereoTypeFontColor	LabelStereoTypeFontSize	PersonStereoTypeThickness	StateMessageAlignment
BiddableBackgroundColor	DesignedDomainStereoTypeFontName	LabelStereoTypeFontStyle	QueueFontColor	StereoTypePosition
BiddableBorderColor	DesignedDomainStereoTypeFontSize	LegendBorderThickness	QueueFontName	StorageFontColor
BoundaryFontColor	DesignedDomainStereoTypeFontStyle	LegendFontColor	QueueFontSize	StorageFontName
BoundaryFontName	DiagramBorderColor	LegendFontName	QueueFontStyle	StorageFontSize
BoundaryFontSize	DiagramBorderThickness	LegendFontStyle	QueueStereoTypeFontColor	StorageFontStyle
BoundaryFontStyle	DomainBackgroundColor	LexicalBackgroundColor	QueueStereoTypeFontName	StorageStereoTypeFontColor
BoundaryStereoTypeFontColor	DomainBorderColor	LexicalBorderThickness	QueueStereoTypeFontSize	StorageStereoTypeFontName
BoundaryStereoTypeFontName	DomainBorderThickness	LifelineStrategy	QueueStereoTypeFontStyle	StorageStereoTypeFontSize
BoundaryStereoTypeFontSize	DomainFontColor	Linetype	Ranksep	StorageStereoTypeFontStyle
BoundaryStereoTypeFontStyle	DomainFontName	MachineBackgroundColor	RectangleBorderThickness	Style
BoxPadding	DomainFontSize	MachineBorderThickness	RectangleFontColor	SvgLinkTarget
CaptionFontColor	DomainFontStyle	MachineBorderThickness	RectangleFontName	SwimlaneBorderThickness
CaptionFontName	DomainStereoTypeFontColor	MachineFontColor	RectangleFontStyle	SwimlaneTitleFontColor
CaptionFontSize	DomainStereoTypeFontName	MachineFontName	RectangleStereoTypeFontColor	SwimlaneTitleFontName
CaptionFontStyle	DomainStereoTypeFontSize	MachineFontSize	RectangleStereoTypeFontName	SwimlaneTitleFontSize
CardBorderThickness	DomainStereoTypeFontStyle	MachineFontStyle	RectangleStereoTypeFontSize	SwimlaneTitleFontStyle
CardFontColor	Dpi	MachineStereoTypeFontColor	RectangleStereoTypeFontStyle	SwimlaneWidth
CardFontName	EntityFontColor	MachineStereoTypeFontName	RequirementBackgroundColor	SwimlaneWrapTitleWidth
CardFontSize	EntityFontName	MachineStereoTypeFontSize	RequirementBorderThickness	TabSize
CardFontStyle	EntityFontStyle	MachineStereoTypeFontStyle	RequirementBorderThickness	TimingFontColor
CardStereoTypeFontColor	EntityStereoTypeFontColor	MaxAsciiMessageLength	RequirementFontColor	TimingFontName
CardStereoTypeFontName	EntityStereoTypeFontName	MaxMessageSize	RequirementFontName	TimingFontSize
CardStereoTypeFontSize	EntityStereoTypeFontSize	MinClassWidth	RequirementFontStyle	TimingFontStyle
CardStereoTypeFontStyle	EntityStereoTypeFontStyle	Monochrome	RequirementFontStyle	TitleBorderRoundCorner
CircledCharacterFontColor	FileFontColor	NodeFontColor	RequirementStereoTypeFontColor	TitleBorderThickness
CircledCharacterFontName	FileFontName	NodeFontName	RequirementStereoTypeFontName	TitleFontColor
CircledCharacterFontSize	FileFontSize	NodeFontSize	RequirementStereoTypeFontSize	TitleFontName
CircledCharacterFontStyle	FileFontStyle	NodeFontStyle	RequirementStereoTypeFontStyle	TitleFontSize
CircledCharacterRadius	FileStereoTypeFontColor	NodeStereoTypeFontColor	RequirementStereoTypeFontStyle	TitleFontStyle
ClassAttributeFontColor	FileStereoTypeFontName	NodeStereoTypeFontName	ResponseMessageBelowArrow	UseCaseBorderThickness
ClassAttributeFontName	FileStereoTypeFontSize	NodeStereoTypeFontName	RoundCorner	UseCaseFontColor
ClassAttributeFontSize	FileStereoTypeFontStyle	NodeStereoTypeFontSize	SameClassWidth	UseCaseFontName
ClassAttributeFontStyle	FixCircleLabelOverlapping	NodeStereoTypeFontStyle	SequenceActorBorderThickness	UseCaseFontSize
ClassAttributeIconSize	FolderFontColor	Nodessep	SequenceArrowThickness	UseCaseFontStyle
ClassBackgroundColor	FolderFontName	NoteBackgroundColor	SequenceBoxBorderThickness	UseCaseStereoTypeFontColor
ClassBorderColor	FolderFontStyle	NoteBorderThickness	SequenceBoxFontColor	UseCaseStereoTypeFontName
ClassBorderThickness	FolderFontSize	NoteFontColor	SequenceBoxFontName	UseCaseStereoTypeFontSize
ClassFontColor	FolderFontStyle	NoteFontName	SequenceBoxFontStyle	UseCaseStereoTypeFontStyle
ClassFontName	FolderStereoTypeFontColor	NoteFontStyle	SequenceDelayFontColor	WrapWidth
ClassFontSize	FolderStereoTypeFontName	NoteFontSize		



24.10.4 All Skin Parameters on the Ashley's PlantUML Doc

You can also view each skinparam parameters with its results displayed at the page [All Skin Parameters of Ashley's PlantUML Doc](#):

- <https://plantuml-documentation.readthedocs.io/en/latest/formatting/all-skin-params.html>.

25 Preprocesseur

Des fonctionnalités de preprocessing ont été incluses dans **PlantUML** et sont disponibles pour *tous* les diagrammes.

Ces fonctionnalités sont assez proches du préprocesseur du langage C, à la différence pour le caractère # a été remplacé par le point d'exclamation !.

25.1 Variable definition [=, ?=]

Although this is not mandatory, we highly suggest that variable names start with a \$.

There are three types of data:

- **Integer number** (*int*);
- **String** (*str*) - these must be surrounded by single quote or double quote;
- **JSON** (JSON) - these must be surrounded by curly brackets.

(for JSON variable definition and usage, see more details on *Preprocessing-JSON page*)

Variables created outside function are **global**, that is you can access them from everywhere (including from functions). You can emphasize this by using the optional `global` keyword when defining a variable.

```
@startuml
!$a = 42
!$ab = "foo1"
!$cd = "foo2"
!$ef = $ab + $cd
!$foo = { "name": "John", "age" : 30 }

Alice -> Bob : $a
Alice -> Bob : $ab
Alice -> Bob : $cd
Alice -> Bob : $ef
Alice -> Bob : Do you know **$foo.name** ?
@enduml
```

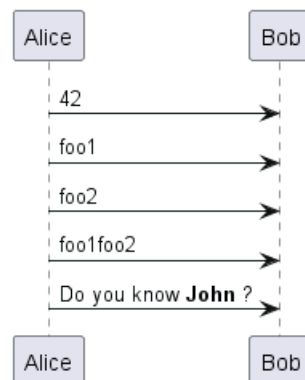

You can also assign a value to a variable, only if it is not already defined, with the syntax: `!$a ?= "foo"`

```
@startuml
Alice -> Bob : 1. **$name** should be empty

!$name ?= "Charlie"
Alice -> Bob : 2. **$name** should be Charlie

!$name = "David"
Alice -> Bob : 3. **$name** should be David

!$name ?= "Ethan"
```



```
Alice -> Bob : 4. **$name** should be David
@enduml
```

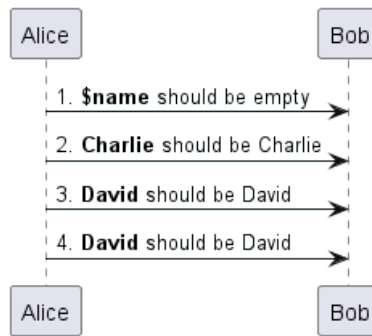

25.2 Boolean expression

25.2.1 Boolean representation [0 is false]

There is not real boolean type, but PlantUML use this integer convention:

- Integer 0 means **false**
- and any non-null number (as 1) or any string (as "1", or even "0") means **true**.

[Ref. QA-9702]

25.2.2 Boolean operation and operator [&&, ||, ()]

You can use boolean expression, in the test, with :

- *parenthesis* ();
- *and operator* &&;
- *or operator* ||.

(See next example, within *if* test.)

25.2.3 Boolean builtin functions [%false(), %true(), %not(<exp>)]

For convenience, you can use those boolean builtin functions:

- %false()
- %true()
- %not(<exp>)

[See also *Builtin functions*]

25.3 Conditions [!if, !else, !elseif, !endif]

- You can use expression in condition.
- *else* and *elseif* are also implemented

```
@startuml
!$a = 10
!$ijk = "foo"
Alice -> Bob : A
!if ($ijk == "foo") && ($a+10>=4)
Alice -> Bob : yes
!else
Alice -> Bob : This should not appear
!endif
Alice -> Bob : B
```



```
@enduml
```

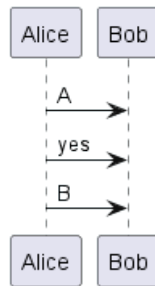

25.4 While loop [!while, !endwhile]

You can use `!while` and `!endwhile` keywords to have repeat loops.

25.4.1 While loop (on Activity diagram)

```
@startuml
!procedure $foo($arg)
  :procedure start;
  !while $arg!=0
    !$i=3
    #palegreen:arg=$arg;
    !while $i!=0
      :arg=$arg and i=$i;
      !$i = $i - 1
    !endwhile
    !$arg = $arg - 1
  !endwhile
  :procedure end;
!endprocedure

start
$foo(2)
end
@enduml
```



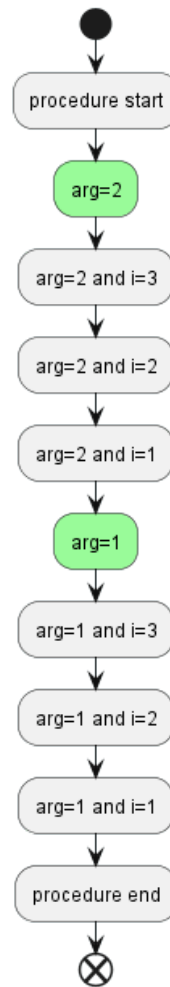

[Adapted from QA-10838]

25.4.2 While loop (on Mindmap diagram)

```

@startmindmap
!procedure $foo($arg)
  !while $arg!=0
    !$i=3
    **[#palegreen] arg = $arg
    !while $i!=0
      *** i = $i
      !$i = $i - 1
    !endwhile
    !$arg = $arg - 1
  !endwhile
!endprocedure

*:While
Loop;
$foo(2)
@endmindmap
  
```



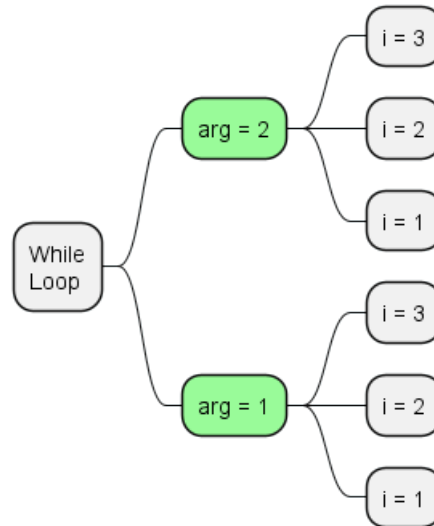

25.4.3 While loop (on Component/Deployment diagram)

```

@startuml
!procedure $foo($arg)
  !while $arg!=0
    [Component $arg] as $arg
    !$arg = $arg - 1
  !endwhile
!endprocedure

$foo(4)

1->2
3-->4
@enduml
  
```

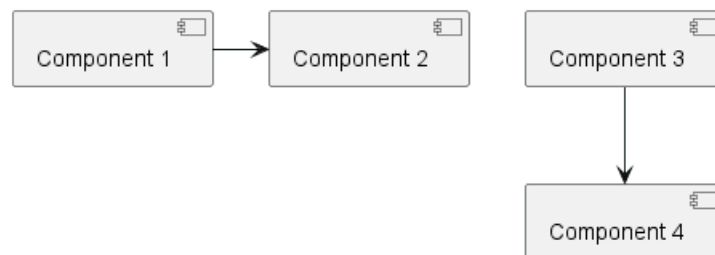

[Ref. QA-14088]

25.5 Procedure [!procedure, !endprocedure]

- Procedure names *should* start with a \$
- Argument names *should* start with a \$
- Procedures can call other procedures

Example:

```

@startuml
!procedure $msg($source, $destination)
  $source --> $destination
!endprocedure
  
```



```
!procedure $init_class($name)
  class $name {
    $addCommonMethod()
  }
!endprocedure
```

```
!procedure $addCommonMethod()
  toString()
  hashCode()
!endprocedure
```

```
$init_class("foo1")
$init_class("foo2")
$msg("foo1", "foo2")
@enduml
```

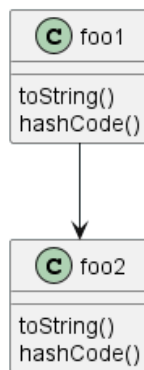

Variables defined in procedures are **local**. It means that the variable is destroyed when the procedure ends.

25.6 Return function [!function, !endfunction]

A return function does not output any text. It just define a function that you can call:

- directly in variable definition or in diagram text
- from other return functions
- from procedures
- Function name *should* start with a \$
- Argument names *should* start with a \$

```
@startuml
!function $double($a)
!return $a + $a
!endfunction
```

```
Alice -> Bob : The double of 3 is $double(3)
@enduml
```

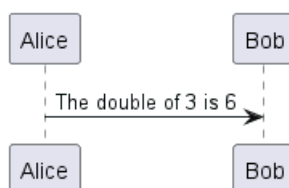

It is possible to shorten simple function definition in one line:

```
@startuml
!function $double($a) !return $a + $a

Alice -> Bob : The double of 3 is $double(3)
Alice -> Bob : $double("This work also for strings.")
@enduml
```

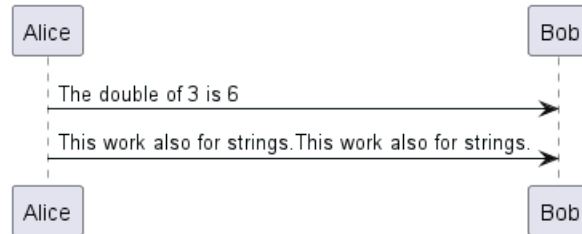

As in procedure (void function), variables are local by default (they are destroyed when the function is exited). However, you can access global variables from a function. However, you can use the `local` keyword to create a local variable if ever a global variable exists with the same name.

```
@startuml
!function $dummy()
!local $ijk = "local"
!return "Alice -> Bob : " + $ijk
!endfunction

!global $ijk = "foo"

Alice -> Bob : $ijk
$dummy()
Alice -> Bob : $ijk
@enduml
```

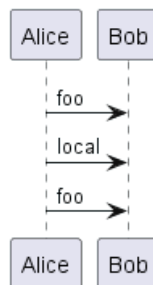

25.7 Default argument value

In both procedure and return functions, you can define default values for arguments.

```
@startuml
!function $inc($value, $step=1)
!return $value + $step
!endfunction

Alice -> Bob : Just one more $inc(3)
Alice -> Bob : Add two to three : $inc(3, 2)
@enduml
```



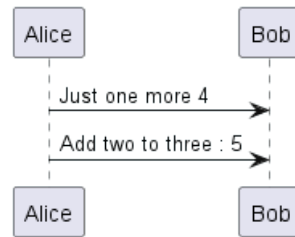

Only arguments at the end of the parameter list can have default values.

```

@startuml
!procedure defaulttest($x, $y="DefaultY", $z="DefaultZ")
note over Alice
  x = $x
  y = $y
  z = $z
end note
!endprocedure

defaulttest(1, 2, 3)
defaulttest(1, 2)
defaulttest(1)
@enduml
  
```

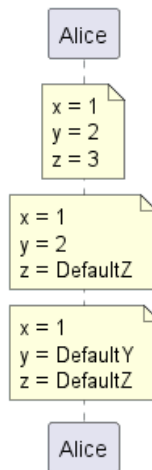

25.8 Unquoted procedure or function [!unquoted]

By default, you have to put quotes when you call a function or a procedure. It is possible to use the `unquoted` keyword to indicate that a function or a procedure does not require quotes for its arguments.

```

@startuml
!unquoted function id($text1, $text2="FOO") !return $text1 + $text2

alice -> bob : id(aa)
alice -> bob : id(ab,cd)
@enduml
  
```

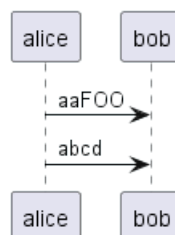

25.9 Keywords arguments

Like in Python, you can use keywords arguments :

```
@startuml

!unquoted procedure $element($alias, $description="", $label="", $technology="", $size=12, $colour="")
rectangle $alias as "
<color:$colour><<$alias>></color>
==$label==
//<size:$size>[$technology]</size>//

    $description"
!endprocedure

$element(myalias, "This description is %newline()on several lines", $size=10, $technology="Java")
@enduml
```

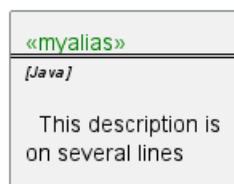

25.10 Including files or URL [!include, !include_many, !include_once]

Use the `!include` directive to include file in your diagram. Using URL, you can also include file from Internet/Intranet. Protected Internet resources can also be accessed, this is described in URL authentication.

Imagine you have the very same class that appears in many diagrams. Instead of duplicating the description of this class, you can define a file that contains the description.

```
@startuml

interface List
List : int size()
List : void clear()
List <|.. ArrayList
@enduml
```

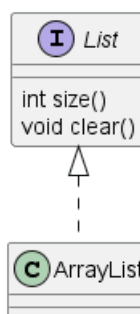

File List.iuml

```
interface List
List : int size()
List : void clear()
```

The file `List.iuml` can be included in many diagrams, and any modification in this file will change all diagrams that include it.



You can also put several `@startuml/@enduml` text block in an included file and then specify which block you want to include adding `!0` where 0 is the block number. The `!0` notation denotes the first diagram.

For example, if you use `!include foo.txt!1`, the second `@startuml/@enduml` block within `foo.txt` will be included.

You can also put an id to some `@startuml/@enduml` text block in an included file using `@startuml(id=MY_OWN_ID)` syntax and then include the block adding `!MY_OWN_ID` when including the file, so using something like `!include foo.txt!MY_OWN_ID`.

By default, a file can only be included once. You can use `!include_many` instead of `!include` if you want to include some file several times. Note that there is also a `!include_once` directive that raises an error if a file is included several times.

25.11 Including Subpart [`!startsub`, `!endsub`, `!includesub`]

You can also use `!startsub NAME` and `!endsub` to indicate sections of text to include from other files using `!includesub`. For example:

file1.puml:

```
@startuml

A -> A : stuff1
!startsub BASIC
B -> B : stuff2
!endsub
C -> C : stuff3
!startsub BASIC
D -> D : stuff4
!endsub
@enduml
```

file1.puml would be rendered exactly as if it were:

```
@startuml

A -> A : stuff1
B -> B : stuff2
C -> C : stuff3
D -> D : stuff4
@enduml
```

However, this would also allow you to have another file2.puml like this:

file2.puml

```
@startuml

title this contains only B and D
!includesub file1.puml!BASIC
@enduml
```

This file would be rendered exactly as if:

```
@startuml

title this contains only B and D
B -> B : stuff2
D -> D : stuff4
@enduml
```

25.12 Builtin functions [%]

Some functions are defined by default. Their name starts by %



Name	Description
%chr	Return a character from a give Unicode value
%darken	Return a darken color of a given color with some ratio
%date	Retrieve current date. You can provide an optional format for the date You can provide another optional time (on epoch format)
%dec2hex	Return the hexadecimal string (String) of a decimal value (Int)
%dirpath	Retrieve current dirpath
%feature	Check if some feature is available in the current PlantUML running version
%false	Return always false
%file_exists	Check if a file exists on the local filesystem
%filename	Retrieve current filename
%function_exists	Check if a function exists
%get_variable_value	Retrieve some variable value
%getenv	Retrieve environment variable value
%hex2dec	Return the decimal value (Int) of a hexadecimal string (String)
%hsl_color	Return the RGBA color from a HSL color %hsl_color(h, s, l) or %hsl_color(h, s, l, a)
%intval	Convert a String to Int
%is_dark	Check if a color is a dark one
%is_light	Check if a color is a light one
%lighten	Return a lighten color of a given color with some ratio
%load_json	Load JSON data from local file or external URL
%lower	Return a lowercase string
%newline	Return a newline
%not	Return the logical negation of an expression
%now	Return the current epoch time
%ord	Return a Unicode value from a given character
%lighten	Return a lighten color of a given color with some ratio
%reverse_color	Reverse a color using RGB
%reverse_hsluv_color	Reverse a color using HSLuv
%set_variable_value	Set a global variable
%size	Return the size of any string or JSON structure
%string	Convert an expression to String
%strlen	Calculate the length of a String
%strpos	Search a substring in a string
%substr	Extract a substring. Takes 2 or 3 arguments
%true	Return always true
%upper	Return an uppercase string
%variable_exists	Check if a variable exists
%version	Return PlantUML current version

25.13 Logging [!log]

You can use `!log` to add some log output when generating the diagram. This has no impact at all on the diagram itself. However, those logs are printed in the command line's output stream. This could be useful for debug purpose.

```
@startuml
!function bold($text)
!$result = "<b>"+ $text + "</b>"
!log Calling bold function with $text. The result is $result
!return $result
!endfunction

Alice -> Bob : This is bold("bold")
Alice -> Bob : This is bold("a second call")
@enduml
```



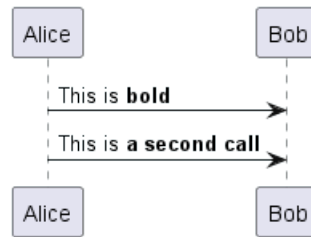

25.14 Memory dump [!dump_memory]

You can use `!dump_memory` to dump the full content of the memory when generating the diagram. An optional string can be put after `!dump_memory`. This has no impact at all on the diagram itself. This could be useful for debug purpose.

```

@startuml
!function $inc($string)
!$val = %intval($string)
!log value is $val
!dump_memory
!return $val+1
!endfunction

Alice -> Bob : 4 $inc("3")
!unused = "foo"
!dump_memory EOF
@enduml
  
```

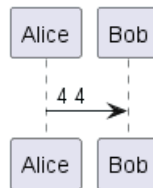

25.15 Assertion [!assert]

You can put assertions in your diagram.

```

@startuml
Alice -> Bob : Hello
!assert %strpos("abcdef", "cd")==3 : "This always fails"
@enduml
  
```

Welcome to PlantUML!

You can start with a simple UML Diagram like:

```
Bob->Alice: Hello
```

Or

```
class Example
```

You will find more information about PlantUML syntax on <https://plantuml.com>

(Details by typing `license` keyword)



```
PlantUML 1.2023.11
[From string (line 3) ]
@startuml
Alice -> Bob : Hello
!assert %strpos("abcdef", "cd")==3 : "This always fails"
Assertion error : This always fails
```

25.16 Building custom library [!import, !include]

It's possible to package a set of included files into a single .zip or .jar archive. This single zip/jar can then be imported into your diagram using `!import` directive.

Once the library has been imported, you can `!include` file from this single zip/jar.

Example:

```
@startuml

!import /path/to/customLibrary.zip
' This just adds "customLibrary.zip" in the search path

!include myFolder/myFile.iuml
' Assuming that myFolder/myFile.iuml is located somewhere
' either inside "customLibrary.zip" or on the local filesystem

...
```

25.17 Search path

You can specify the java property `plantuml.include.path` in the command line.

For example:

```
java -Dplantuml.include.path="c:/mydir" -jar plantuml.jar atest1.txt
```

Note the this `-D` option has to put before the `-jar` option. `-D` options after the `-jar` option will be used to define constants within plantuml preprocessor.

25.18 Argument concatenation [##]

It is possible to append text to a macro argument using the `##` syntax.

```
@startuml
!unquoted procedure COMP_TEXTGENCOMP(name)
[name] << Comp >>
interface Ifc << IfcType >> AS name##Ifc
name##Ifc - [name]
!endprocedure
COMP_TEXTGENCOMP(dummy)
@enduml
```



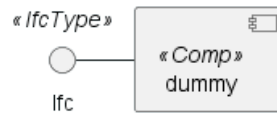

25.19 Dynamic invocation [%invoke_procedure(), %call_user_func()]

You can dynamically invoke a procedure using the special `%invoke_procedure()` procedure. This procedure takes as first argument the name of the actual procedure to be called. The optional following arguments are copied to the called procedure.

For example, you can have:

```

@startuml
!procedure $go()
  Bob -> Alice : hello
!endprocedure

!$wrapper = "$go"

%invoke_procedure($wrapper)
@enduml
  
```

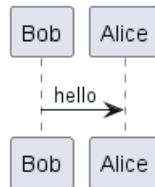

```

@startuml
!procedure $go($txt)
  Bob -> Alice : $txt
!endprocedure

%invoke_procedure("$go", "hello from Bob...")
@enduml
  
```

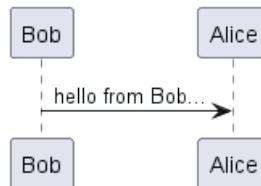

For return functions, you can use the corresponding special function `%call_user_func()` :

```

@startuml
!function bold($text)
!return "<b>"+ $text +"</b>"
!endfunction

Alice -> Bob : %call_user_func("bold", "Hello") there
@enduml
  
```

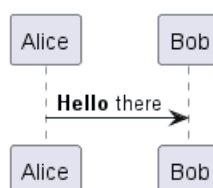

25.20 Evaluation of addition depending of data types [+]

Evaluation of $\$a + \b depending of type of $\$a$ or $\$b$

```
@startuml
title
<#LightBlue>|= |= $a |= $b |= <U+0025>string($a + $b)|
<#LightGray>| type | str | str | str (concatenation) |
| example |= "a" |= "b" |= %string("a" + "b") |
<#LightGray>| type | str | int | str (concatenation) |
| ex. |= "a" |= 2 |= %string("a" + 2) |
<#LightGray>| type | str | int | str (concatenation) |
| ex. |= 1 |= "b" |= %string(1 + "b") |
<#LightGray>| type | bool | str | str (concatenation) |
| ex. |= <U+0025>true() |= "b" |= %string(%true() + "b") |
<#LightGray>| type | str | bool | str (concatenation) |
| ex. |= "a" |= <U+0025>false() |= %string("a" + %false()) |
<#LightGray>| type | int | int | int (addition of int) |
| ex. |= 1 |= 2 |= %string(1 + 2) |
<#LightGray>| type | bool | int | int (addition) |
| ex. |= <U+0025>true() |= 2 |= %string(%true() + 2) |
<#LightGray>| type | int | bool | int (addition) |
| ex. |= 1 |= <U+0025>false() |= %string(1 + %false()) |
<#LightGray>| type | int | int | int (addition) |
| ex. |= 1 |= <U+0025>intval("2") |= %string(1 + %intval("2")) |
end title
@enduml
```

	$\$a$	$\$b$	$\%string(\$a + \$b)$
type	str	str	str (concatenation)
example	"a"	"b"	ab
type	str	int	str (concatenation)
ex.	"a"	2	a2
type	str	int	str (concatenation)
ex.	1	"b"	1b
type	bool	str	str (concatenation)
ex.	$\%true()$	"b"	1b
type	str	bool	str (concatenation)
ex.	"a"	$\%false()$	a0
type	int	int	int (addition of int)
ex.	1	2	3
type	bool	int	int (addition)
ex.	$\%true()$	2	3
type	int	bool	int (addition)
ex.	1	$\%false()$	1
type	int	int	int (addition)
ex.	1	$\%intval("2")$	3

25.21 Preprocessing JSON

You can extend the functionality of the current Preprocessing with JSON Preprocessing features:

- JSON Variable definition
- Access to JSON data
- Loop over JSON array

(See more details on *Preprocessing-JSON page*)

25.22 Including theme [!theme]

Use the `!theme` directive to change the default theme of your diagram.



```
@startuml
!theme spacelab
class Example {
  Theme spacelab
}
@enduml
```

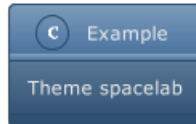

You will find more information on the dedicated page.

25.23 Migration notes

The current preprocessor is an update from some legacy preprocessor.

Even if some legacy features are still supported with the actual preprocessor, you should not use them any more (they might be removed in some long term future).

- You should not use `!define` and `!definelong` anymore. Use `!function`, `!procedure` or variable definition instead.
 - `!define` should be replaced by `return !function`
 - `!definelong` should be replaced by `!procedure`.
- `!include` now allows multiple inclusions : you don't have to use `!include_many` anymore
- `!include` now accepts a URL, so you don't need `!includeurl`
- Some features (like `%date%`) have been replaced by builtin functions (for example `%date()`)
- When calling a legacy `!definelong` macro with no arguments, you do have to use parenthesis. You have to use `my_own_definelong()` because `my_own_definelong` without parenthesis is not recognized by the new preprocessor.

Please contact us if you have any issues.

25.24 %Splitstr builtin function

```
@startmindmap
!$list = %splitstr("abc~def~ghi", "~")

* root
!foreach $item in $list
  ** $item
!endfor
@endmindmap
```

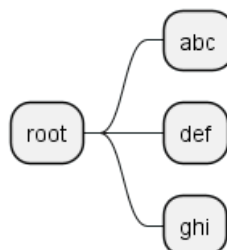

[Ref. QA-15374]



26 Unicode

Le langage PlantUML utilise des *lettres* pour définir les acteurs, les cas d'utilisation, etc.

Mais les *lettres* ne sont pas seulement des caractères latins A-Z, il peut s'agir de *n'importe quel type de lettre de n'importe quelle langue*

26.1 Examples

```
@startuml
skinparam handwritten true
skinparam backgroundColor #EEEEBC

actor 使用者
participant "頭等艙" as A
participant "第二類" as B
participant "最後一堂課" as 别的東西

使用者 -> A: 完成這項工作
activate A

A -> B: 創建請求
activate B

B -> 别的東西: 創建請求
activate 别的東西
别的東西 --> B: 這項工作完成
destroy 别的東西

B --> A: 請求創建
deactivate B

A --> 使用者: 做完
deactivate A
@enduml
```

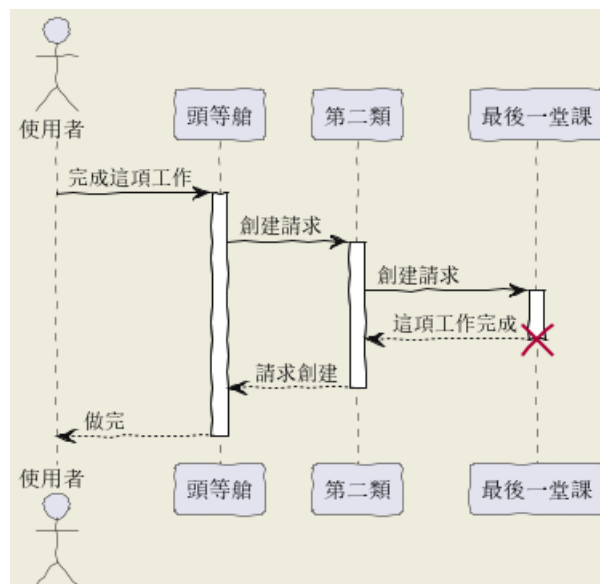

```
@startuml

(*) --> "膩平台"
--> === S1 ===
--> 鞠躬向公眾
```



```
--> === S2 ===
--> 這傢伙波武器
--> (*)
```

```
skinparam backgroundColor #AFFFFF
skinparam activityStartColor red
skinparam activityBarColor SaddleBrown
skinparam activityEndColor Silver
skinparam activityBackgroundColor Peru
skinparam activityBorderColor Peru
@enduml
```

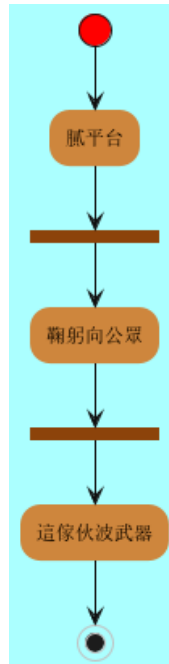

```
@startuml
```

```
skinparam usecaseBackgroundColor DarkSeaGreen
skinparam usecaseArrowColor Olive
skinparam actorBorderColor black
skinparam usecaseBorderColor DarkSlateGray
```

```
使用者 << 人類 >>
"主數據庫" as 數據庫 << 應用程式 >>
(草創) << 一桿 >>
"主数据燕" as (贏余) << 基本的 >>
```

```
使用者 -> (草創)
使用者 --> (贏余)
```

```
數據庫 --> (贏余)
@enduml
```



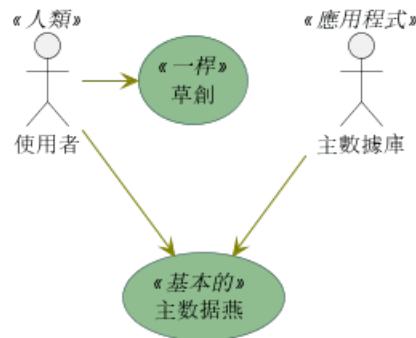

```

@startuml
() "Σ" as Σ
Σ - [Π ]
[Π ] ..> () A : A
@enduml

```

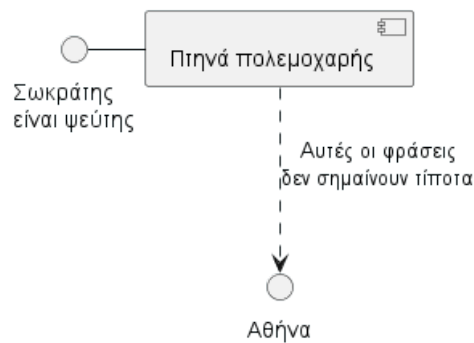

26.2 Jeu de caractères

Le jeu de caractères par défaut utilisé lors de la *lecture des* fichiers texte contenant la description textuelle UML dépend du système.

Normalement, il devrait convenir, mais dans certains cas, vous pouvez souhaiter utiliser un autre jeu de caractères. Par exemple, avec la ligne de commande

```
java -jar plantuml.jar -charset UTF-8 files.txt
```

ou avec la tâche ant

```

<!-- Put images in c:/images directory -->
<target name="main">
<plantuml dir="./src" charset="UTF-8" />

```

En fonction de votre installation Java, les jeux de caractères suivants devraient être disponibles : ISO-8859-1, UTF-8, UTF-16BE, UTF-16LE, UTF-16

26.3 Using Unicode Character on PlantUML

On PlantUML diagram, you can integrate:

- Special characters using `&#XXXX;` or `<U+XXXX>` form;
- Emoji using `<:XXXXX:>` or `<:NameOfEmoji:>` form.



27 Bibliothèque standard de PlantUML

Bienvenue au guide sur la **bibliothèque standard** officielle de PlantUML (`stdlib`). Ici, nous nous plongeons dans cette ressource intégrale qui est maintenant incluse dans toutes les versions officielles de PlantUML, facilitant une expérience de création de diagramme plus riche. La bibliothèque emprunte sa convention d'inclusion de fichiers à la "bibliothèque standard C", un protocole bien établi dans le monde de la programmation.

27.0.1 Vue d'ensemble de la bibliothèque standard

La bibliothèque standard est un dépôt de fichiers et de ressources, constamment mis à jour pour améliorer votre expérience de PlantUML. Elle forme l'épine dorsale de PlantUML, offrant une gamme de fonctionnalités et de caractéristiques à explorer.

27.0.2 Contribution de la communauté

Une partie importante du contenu de la bibliothèque est généreusement fournie par des contributeurs tiers. Nous leur exprimons notre sincère gratitude pour leurs contributions inestimables qui ont joué un rôle essentiel dans l'enrichissement de la bibliothèque.

Nous encourageons les utilisateurs à se plonger dans les abondantes ressources offertes par la bibliothèque standard, non seulement pour améliorer leur expérience de création de diagrammes, mais aussi pour contribuer et faire partie de cet effort de collaboration.

27.1 Contenu de la bibliothèque standard

Vous pouvez obtenir le contenu la bibliothèque standard à l'aide du diagramme spécial suivant:

```
@startuml
stdlib
@enduml
```

archimate

Version 1.1.0

Delivered by <https://github.com/plantuml-stdlib/Archimate-PlantUML>**aws**

Version 18.02.22

Delivered by <https://github.com/milo-minderbinder/AWS-PlantUML>**awslib**

Version 14.0.0

Delivered by <https://github.com/awslabs/aws-icons-for-plantuml>**azure**

Version 2.2.0

Delivered by <https://github.com/plantuml-stdlib/Azure-PlantUML>**c4**

Version 2.8.0

Delivered by <https://github.com/plantuml-stdlib/C4-PlantUML>**classy**

Version 1.0.0

Delivered by <https://github.com/james-gadrow-kr/classy-plantuml>**classy-c4**

Version 1.0.0

Delivered by <https://github.com/james-gadrow-kr/classy-c4>**cloudinsight**

Version 1.0.0

Delivered by <https://github.com/plantuml-stdlib/cicon-plantuml-sprites>**cloudogu**

Version 1.0.2

Delivered by <https://github.com/cloudogu/plantuml-cloudogu-sprites>**domainstory**

Version 0.3

Delivered by <https://github.com/johthor/DomainStory-PlantUML>**elastic**

Version 0.0.1

Delivered by <https://github.com/Crashedmind/PlantUML-Elastic-icons>**kubernetes**

Version 5.3.45

Delivered by <https://github.com/plantuml-stdlib/plantuml-kubernetes-sprites>**logos**

Version 1.1.0

Delivered by <https://github.com/plantuml-stdlib/gilbarbara-plantuml-sprites>**material**

Version 0.0.1

Delivered by <https://github.com/Templarian/MaterialDesign>**office**

Version 1.0.0

Delivered by <https://github.com/Roemer/plantuml-office>**osa**

Version 0.0.1

Delivered by <https://github.com/Crashedmind/PlantUML-opensecurityarchitecture-icons>**tupadr3**

Version 2.4.0

Delivered by <https://github.com/tupadr3/plantuml-icon-font-sprites>

Il est également possible d'utiliser la ligne de commande `java -jar plantuml.jar -stdlib` pour afficher cette même liste.

Enfin, vous pouvez extraire les sources complètes de la bibliothèque standard en utilisant `java -jar plantuml.jar -extractstdlib`. Tous les fichiers seront extraits dans le dossier `stdlib`.



Les sources utilisées pour construire les versions officielles de PlantUML sont hébergées ici <https://github.com/plantuml/plantuml-stdlib>. Vous pouvez créer une demande pour mettre à jour ou ajouter une bibliothèque si vous la trouvez pertinente.

27.2 ArchiMate [archimate]

Type	Lien
stdlib	https://github.com/plantuml/plantuml-stdlib/tree/master/archimate
src	https://github.com/ebbypeter/ArchiMate-PlantUML
orig	https://en.wikipedia.org/wiki/ArchiMate

Ce référentiel contient les macros PlantUML d'ArchiMate et d'autres inclusions pour créer des diagrammes Archimate facilement et de manière cohérente.

```
@startuml
!include <archimate/ArchiMate>

title Archimate Sample - Internet Browser

' Elements
Business_Object(businessObject, "A Business Object")
Business_Process(someBusinessProcess,"Some Business Process")
Business_Service(itSupportService, "IT Support for Business (Application Service)")

Application_DataObject(dataObject, "Web Page Data \n 'on the fly'")
Application_Function(webpageBehaviour, "Web page behaviour")
Application_Component(ActivePartWebPage, "Active Part of the web page \n 'on the fly'")

Technology_Artifact(inMemoryItem,"in memory / 'on the fly' html/javascript")
Technology_Service(internetBrowser, "Internet Browser Generic & Plugin")
Technology_Service(internetBrowserPlugin, "Some Internet Browser Plugin")
Technology_Service(webServer, "Some web server")

'Relationships
Rel_Flow_Left(someBusinessProcess, businessObject, "")
Rel_Serving_Up(itSupportService, someBusinessProcess, "")
Rel_Specialization_Up(webpageBehaviour, itSupportService, "")
Rel_Flow_Right(dataObject, webpageBehaviour, "")
Rel_Specialization_Up(dataObject, businessObject, "")
Rel_Assignment_Left(ActivePartWebPage, webpageBehaviour, "")
Rel_Specialization_Up(inMemoryItem, dataObject, "")
Rel_Realization_Up(inMemoryItem, ActivePartWebPage, "")
Rel_Specialization_Right(inMemoryItem,internetBrowser, "")
Rel_Serving_Up(internetBrowser, webpageBehaviour, "")
Rel_Serving_Up(internetBrowserPlugin, webpageBehaviour, "")
Rel_Aggregation_Right(internetBrowser, internetBrowserPlugin, "")
Rel_Access_Up(webServer, inMemoryItem, "")
Rel_Serving_Up(webServer, internetBrowser, "")
@enduml
```



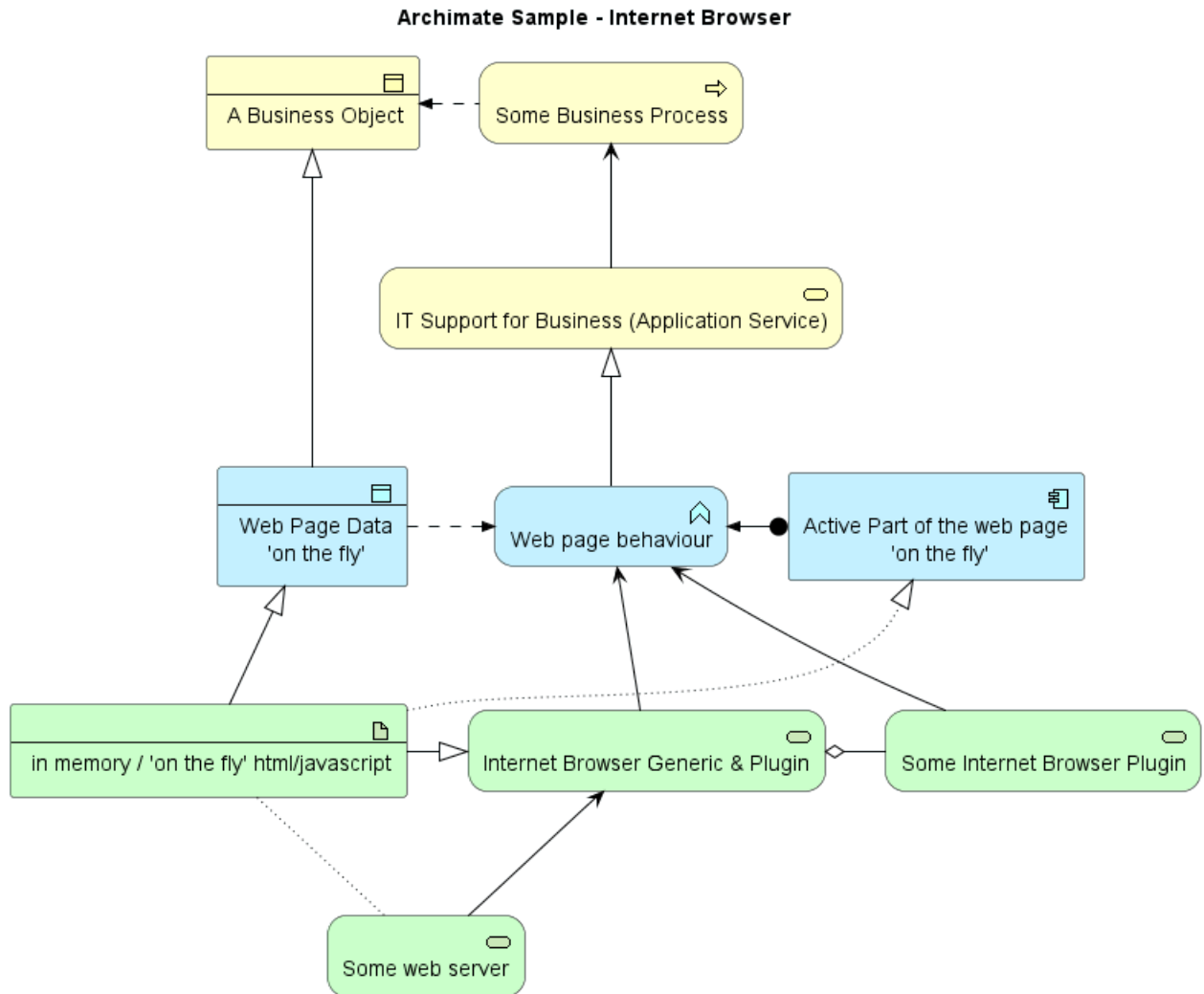

27.2.1 Liste des sprites possibles

Vous pouvez lister tous les sprites possibles pour ArchiMate en utilisant le diagramme suivant

```
@startuml
listsprite
@enduml
```

List Current Sprites

Credit to

<http://www.archimatetool.com>

archimate :

access
 activity
 actor
 aggregation
 application-collaboration
 application-component
 application-data-object
 application-event
 application-function
 application-interaction
 application-interface
 application-process
 application-service
 assessment-filled
 assessment
 assignment
 association-unidirect
 association
 business-activity
 business-actor
 business-collaboration
 business-contract
 business-event
 business-function
 business-interaction
 business-interface
 business-location
 business-meaning
 business-object
 business-process
 business-product
 business-representation
 business-role
 business-service
 business-value
 collaboration
 communication-path
 component
 composition
 constraint-filled
 constraint
 contract
 deliverable-filled
 deliverable
 device
 driver-filled
 driver
 event
 flow
 function
 gap-filled
 gap
 goal-filled
 goal
 implementation-deliverable
 implementation-event
 implementation-gap
 implementation-plateau
 implementation-workpackage
 influence
 interaction
 interface-required

interface-symmetric
 interface
 junction-and
 junction-or
 junction
 location
 meaning
 motivation-assessment
 motivation-constraint
 motivation-driver
 motivation-goal
 motivation-meaning
 motivation-outcome
 motivation-principle
 motivation-requirement
 motivation-stakeholder
 motivation-value
 network
 node
 object
 physical-distribution-network
 physical-equipment
 physical-facility
 physical-material
 plateau
 principle-filled
 principle
 process
 product
 realisation
 representation
 requirement-filled
 requirement
 role

service
 serving
 specialisation
 specialization
 stakeholder-filled
 strategy-capability
 strategy-course-of-action
 strategy-resource
 strategy-value-stream
 system-software
 technology-artifact
 technology-collaboration
 technology-communication-network
 technology-communication-path
 technology-device
 technology-event
 technology-function
 technology-infra-interface
 technology-infra-service
 technology-interaction
 technology-interface
 technology-network
 technology-node
 technology-path
 technology-process
 technology-service
 technology-system-software
 triggering
 used-by
 value
 workpackage-filled

27.3 Amazon Labs AWS Library [awslib]

Type	Link
stdlib	https://github.com/plantuml/plantuml-stdlib/tree/master/awslib
src	https://github.com/aws-labs/aws-icons-for-plantuml
orig	https://aws.amazon.com/en/architecture/icons/

The Amazon Labs AWS library provides PlantUML sprites, macros, and other includes for Amazon Web Services (AWS) services and resources.

Used to create PlantUML diagrams with AWS components. All elements are generated from the official AWS Architecture Icons and when combined with PlantUML and the C4 model, are a great way to communicate your design, deployment, and topology as code.

```

@startuml
!include <awslib/AWSCommon>
!include <awslib/InternetOfThings/IoTRule>
!include <awslib/Analytics/KinesisDataStreams>
!include <awslib/ApplicationIntegration/SimpleQueueService>

```

```
left to right direction
```

```
agent "Published Event" as event #fff
```

```

IoTRule(iotRule, "Action Error Rule", "error if Kinesis fails")
KinesisDataStreams(eventStream, "IoT Events", "2 shards")
SimpleQueueService(errorQueue, "Rule Error Queue", "failed Rule actions")

```

```

event --> iotRule : JSON message
iotRule --> eventStream : messages
iotRule --> errorQueue : Failed action message
@enduml

```



27.4 Azure library [azure]

Type	Link
stdlib	https://github.com/plantuml/plantuml-stdlib/tree/master/azure
src	https://github.com/RicardoNiepel/Azure-PlantUML/
orig	Microsoft Azure

The Azure library consists of Microsoft Azure icons.

Use it by including the file that contains the sprite, eg: `!include <azure/Analytics/AzureEventHub>`.
When imported, you can use the sprite as normally you would, using `<$sprite_name>`.

You may also include the `AzureCommon.puml` file, eg: `!include <azure/AzureCommon>`, which contains helper macros defined. With the `AzureCommon.puml` imported, you can use the `NAME_OF_SPRITE(parameters...)` macro.

Example of usage:

```
@startuml
!include <azure/AzureCommon>
!include <azure/Analytics/AzureEventHub>
!include <azure/Analytics/AzureStreamAnalyticsJob>
!include <azure/Databases/AzureCosmosDb>
```

```
left to right direction
```

```
agent "Device Simulator" as devices #fff
```

```
AzureEventHub(fareDataEventHub, "Fare Data", "PK: Medallion HackLicense VendorId; 3 TUs")
AzureEventHub(tripDataEventHub, "Trip Data", "PK: Medallion HackLicense VendorId; 3 TUs")
AzureStreamAnalyticsJob(streamAnalytics, "Stream Processing", "6 SUs")
AzureCosmosDb(outputCosmosDb, "Output Database", "1,000 RUs")
```

```
devices --> fareDataEventHub
devices --> tripDataEventHub
fareDataEventHub --> streamAnalytics
tripDataEventHub --> streamAnalytics
streamAnalytics --> outputCosmosDb
@enduml
```

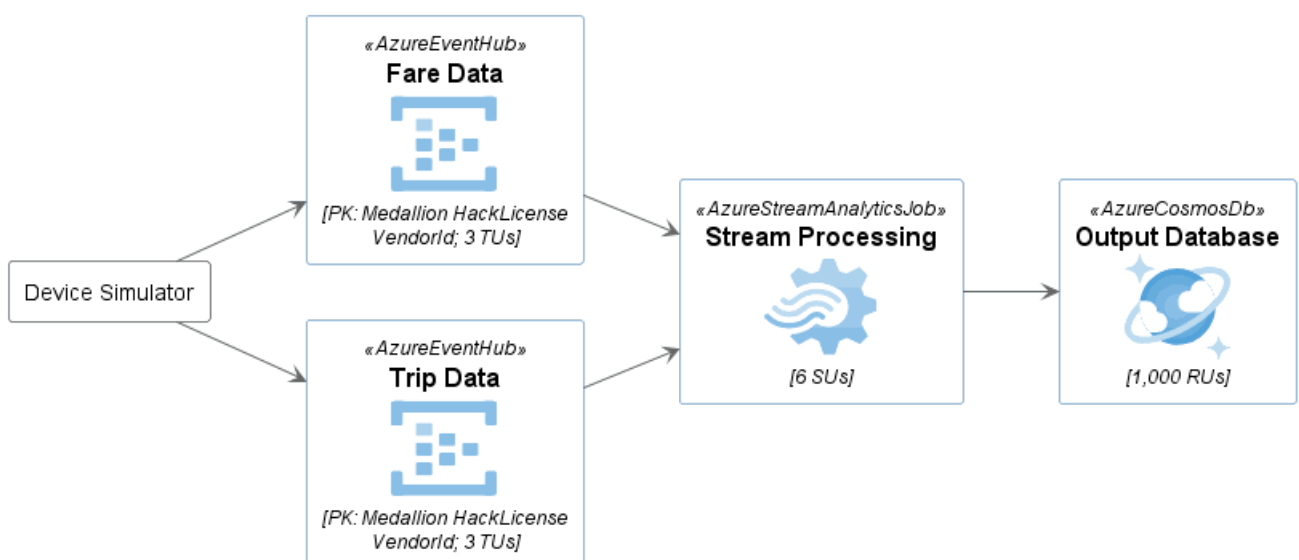

27.5 C4 Library [C4]

Type	Link
stdlib	https://github.com/plantuml/plantuml-stdlib/tree/master/C4
src	https://github.com/plantuml-stdlib/C4-PlantUML
orig	https://en.wikipedia.org/wiki/C4_model https://c4model.com

```

@startuml
!include <C4/C4_Container>

Person(personAlias, "Label", "Optional Description")
Container(containerAlias, "Label", "Technology", "Optional Description")
System(systemAlias, "Label", "Optional Description")

System_Ext(extSystemAlias, "Label", "Optional Description")

Rel(personAlias, containerAlias, "Label", "Optional Technology")

Rel_U(systemAlias, extSystemAlias, "Label", "Optional Technology")
@enduml

```

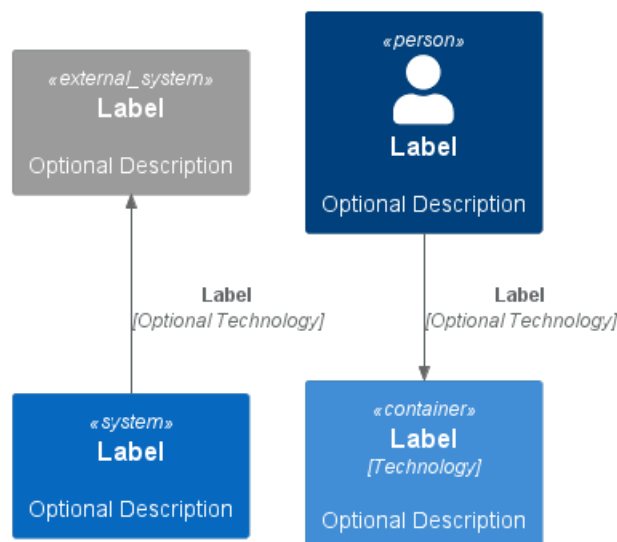

27.6 Cloud Insight [cloudinsight]

Type	Link
stdlib	https://github.com/plantuml/plantuml-stdlib/tree/master/cloudinsight
src	https://github.com/rabelenda/cicon-plantuml-sprites
orig	Cloudinsight icons

This repository contains PlantUML sprites generated from Cloudinsight icons, which can easily be used in PlantUML diagrams for nice visual representation of popular technologies.

```

@startuml
!include <cloudinsight/tomcat>
!include <cloudinsight/kafka>
!include <cloudinsight/java>
!include <cloudinsight/cassandra>

title Cloudinsight sprites example

skinparam monochrome true

rectangle "<$tomcat>\nwebapp" as webapp

```



```

queue "<$kafka>" as kafka
rectangle "<$java>\ndaemon" as daemon
database "<$cassandra>" as cassandra

```

```

webapp -> kafka
kafka -> daemon
daemon --> cassandra
@enduml

```

Cloudinsight sprites example

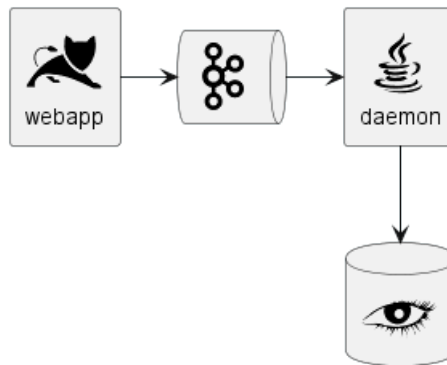

27.7 Clodogu [cloudogu]

Type	Link
stdlib	https://github.com/plantuml/plantuml-stdlib/tree/master/cloudogu
src	https://github.com/cloudogu/plantuml-cloudogu-sprites
orig	https://cloudogu.com

The Clodogu library provides PlantUML sprites, macros, and other includes for Clodogu services and resources.

```

@startuml
!include <cloudogu/common>
!include <cloudogu/dogus/jenkins>
!include <cloudogu/dogus/cloudogu>
!include <cloudogu/dogus/scm>
!include <cloudogu/dogus/smeagol>
!include <cloudogu/dogus/nexus>
!include <cloudogu/tools/k8s>

node "Clodogu Ecosystem" <<$cloudogu>> {
DOGU_JENKINS(jenkins, Jenkins) #ffffff
DOGU_SCM(scm, SCM-Manager) #ffffff
DOGU_SMEAGOL(smeagol, Smeagol) #ffffff
DOGU_NEXUS(nexus, Nexus) #ffffff
}

TOOL_K8S(k8s, Kubernetes) #ffffff

actor developer

developer --> smeagol : "Edit Slides"
smeagol -> scm : Push
scm -> jenkins : Trigger
jenkins -> nexus : Deploy
jenkins --> k8s : Deploy

```



```
@enduml
```

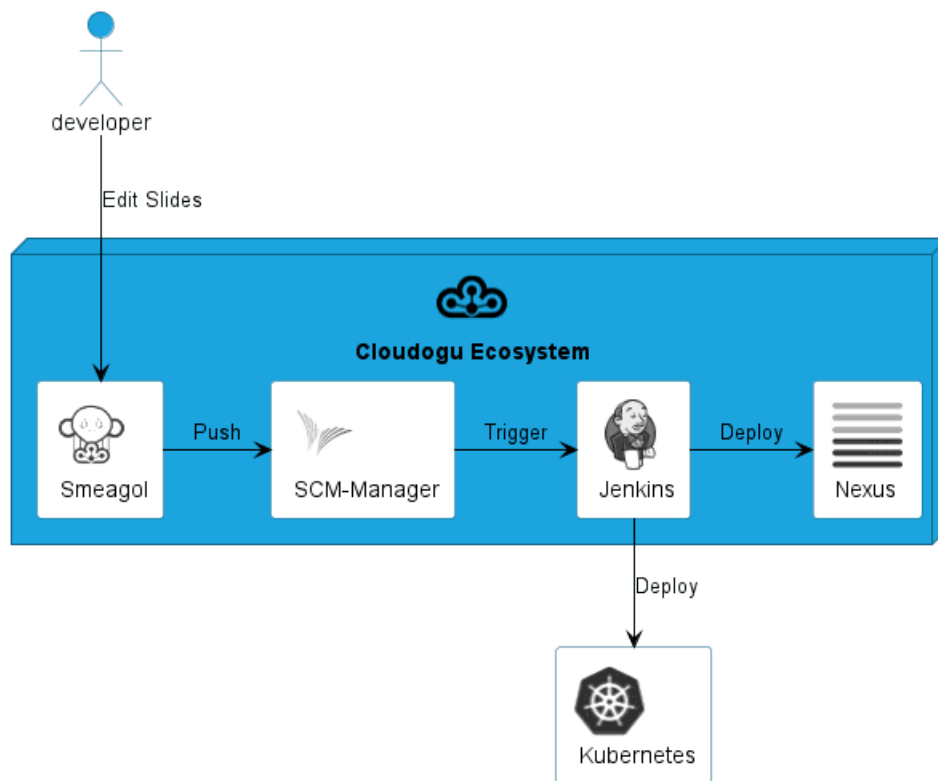

All cloudogu sprites

See all possible cloudogu sprites on [plantuml-cloudogu-sprites](#).

27.8 Elastic library [elastic]

Type	Link
stdlib	https://github.com/plantuml/plantuml-stdlib/tree/master/elastic
src	https://github.com/Crashedmind/PlantUML-Elastic-icons
orig	Elastic

The Elastic library consists of Elastic icons. It is similar in use to the AWS and Azure libraries (it used the same tool to create them).

Use it by including the file that contains the sprite, eg: `!include elastic/elastic_search/elastic_search>`. When imported, you can use the sprite as normally you would, using `<$sprite_name>`.

You may also include the `common.puml` file, eg: `!include <elastic/common>`, which contains helper macros defined. With the `common.puml` imported, you can use the `NAME//OF//SPRITE(parameters...)` macro.

Example of usage:

```

@startuml
!include <elastic/common>
!include <elastic/elasticsearch/elasticsearch>
!include <elastic/logstash/logstash>
!include <elastic/kibana/kibana>

ELASTICSEARCH(ElasticSearch, "Search and Analyze",database)
LOGSTASH(Logstash, "Parse and Transform",node)
KIBANA(Kibana, "Visualize",agent)
  
```

```
Logstash -right-> ElasticSearch: Transformed Data
```



```
ElasticSearch -right-> Kibana: Data to View
@enduml
```

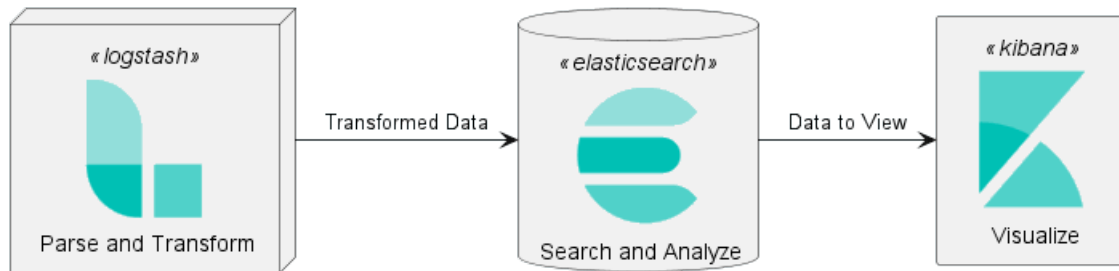

All Elastic Sprite Set

```
@startuml
'Adapted from https://github.com/Crashedmind/PlantUML-Elastic-icons/blob/master/All.puml

'Elastic stuff here
'=====

!include <elastic/common>
!include <elastic/apm/apm>
!include <elastic/app_search/app_search>
!include <elastic/beats/beats>
!include <elastic/cloud/cloud>
!include <elastic/cloud_in_kubernetes/cloud_in_kubernetes>
!include <elastic/code_search/code_search>
!include <elastic/ece/ece>
!include <elastic/eck/eck>
' Beware of the difference between Crashedmind and plantuml-stdlib version: with '_' usage!
!include <elastic/elasticsearch/elasticsearch>
!include <elastic/endpoint/endpoint>
!include <elastic/enterprise_search/enterprise_search>
!include <elastic/kibana/kibana>
!include <elastic/logging/logging>
!include <elastic/logstash/logstash>
!include <elastic/maps/maps>
!include <elastic/metrics/metrics>
!include <elastic/siem/siem>
!include <elastic/site_search/site_search>
!include <elastic/stack/stack>
!include <elastic/uptime/uptime>

skinparam agentBackgroundColor White

APM(apm)
APP_SEARCH(app_search)
BEATS(beats)
CLOUD(cloud)
CLOUD_IN_KUBERNETES(cloud_in_kubernetes)
CODE_SEARCH(code_search)
ECE(ece)
ECK(eck)
ELASTICSEARCH(elastic_search)
ENDPOINT(endpoint)
ENTERPRISE_SEARCH(enterprise_search)
KIBANA(kibana)
LOGGING(logging)
```



```

LOGSTASH(logstash)
MAPS(maps)
METRICS(metrics)
SIEM(siem)
SITE_SEARCH(site_search)
STACK(stack)
UPTIME(uptime)
@enduml

```

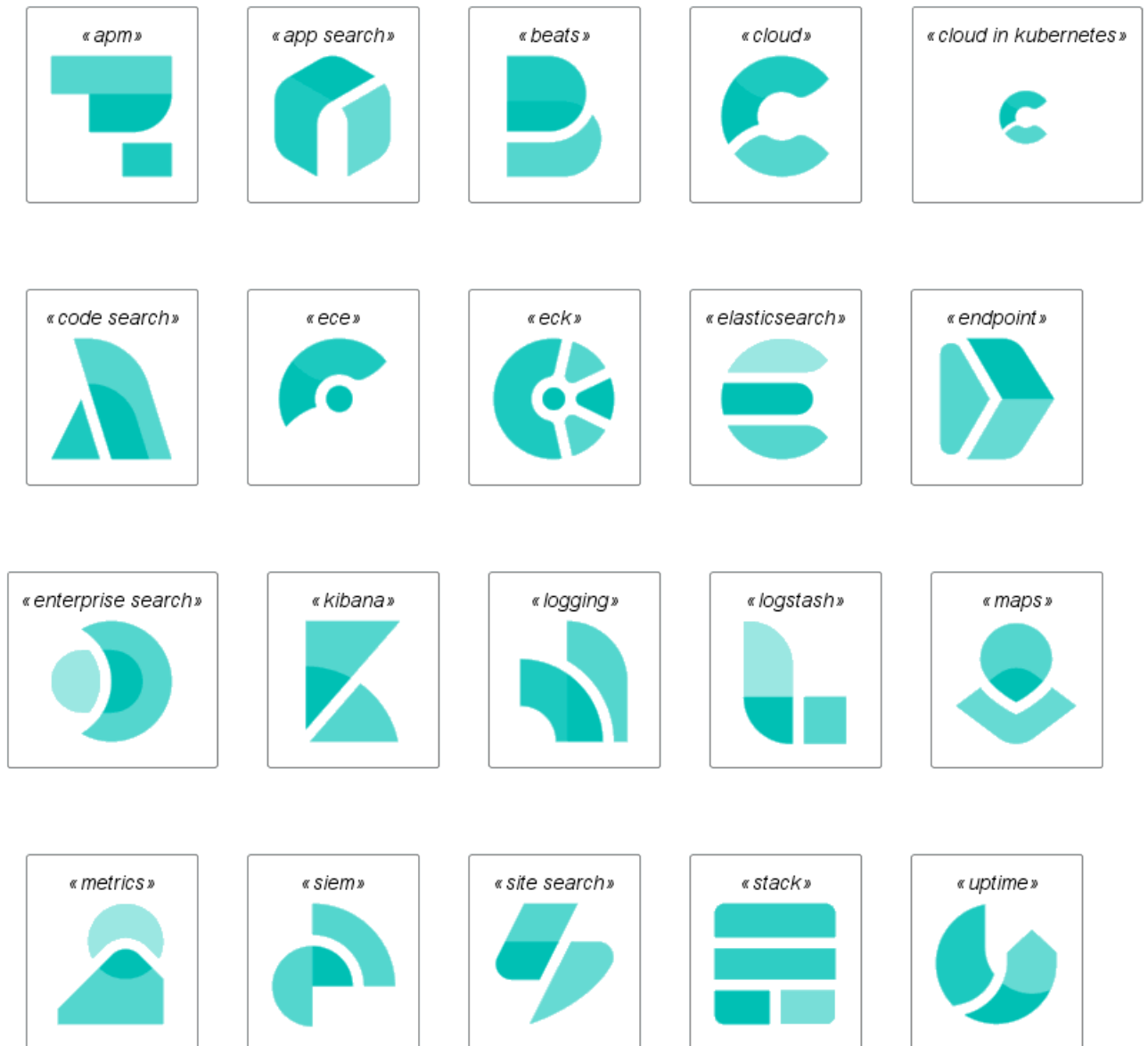

27.9 Google Material Icons [material]

Type	Link
stdlib	https://github.com/plantuml/plantuml-stdlib/tree/master/material
src	https://github.com/Templarian/MaterialDesign
orig	Material Design Icons

This library consists of a free Material style icons from Google and other artists.

Use it by including the file that contains the sprite, eg: `!include <material/ma_folder_move>`. When imported, you can use the sprite as normally you would, using `<$ma_sprite_name>`. Notice that this



library requires an `ma_` prefix on sprites names, this is to avoid clash of names if multiple sprites have the same name on different libraries.

You may also include the `common.puml` file, eg: `!include <material/common>`, which contains helper macros defined. With the `common.puml` imported, you can use the `MA_NAME_OF_SPRITE(parameters...)` macro, note again the use of the prefix `MA_`.

Example of usage:

```
@startuml
!include <material/common>
' To import the sprite file you DON'T need to place a prefix!
!include <material/folder_move>

MA_FOLDER_MOVE(Red, 1, dir, rectangle, "A label")
@enduml
```

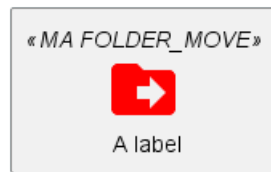

Notes:

When mixing sprites macros with other elements you may get a syntax error if, for example, trying to add a rectangle along with classes. In those cases, add `{` and `}` after the macro to create the empty rectangle.

Example of usage:

```
@startuml
!include <material/common>
' To import the sprite file you DON'T need to place a prefix!
!include <material/folder_move>

MA_FOLDER_MOVE(Red, 1, dir, rectangle, "A label") {

class foo {
    bar
}
@enduml
```



27.10 Kubernetes [kubernetes]

Type	Link
stdlib	https://github.com/plantuml/plantuml-stdlib/tree/master/kubernetes
src	https://github.com/michiel/plantuml-kubernetes-sprites
orig	Kubernetes

```
@startuml
!include <kubernetes/k8s-sprites-unlabeled-25pct>
package "Infrastructure" {
    component "<$master>\nmaster" as master
```



```

component "<$etcd>\netcd" as etcd
component "<$node>\nnode" as node
}
@enduml

```



27.11 Logos [logos]

Type	Link
stdlib	https://github.com/plantuml/plantuml-stdlib/tree/master/logos
src	https://github.com/plantuml-stdlib/gilbarbara-plantuml-sprites
orig	Gil Barbara's logos

This repository contains PlantUML sprites generated from Gil Barbara's logos, which can easily be used in PlantUML diagrams for nice visual aid.

```

@startuml
!include <logos/flask>
!include <logos/kafka>
!include <logos/kotlin>
!include <logos/cassandra>

title Gil Barbara's logos example

skinparam monochrome true

rectangle "<$flask>\nwebapp" as webapp
queue "<$kafka>" as kafka
rectangle "<$kotlin>\ndaemon" as daemon
database "<$cassandra>" as cassandra

webapp -> kafka
kafka -> daemon
daemon --> cassandra
@enduml

```

Gil Barbara's logos example

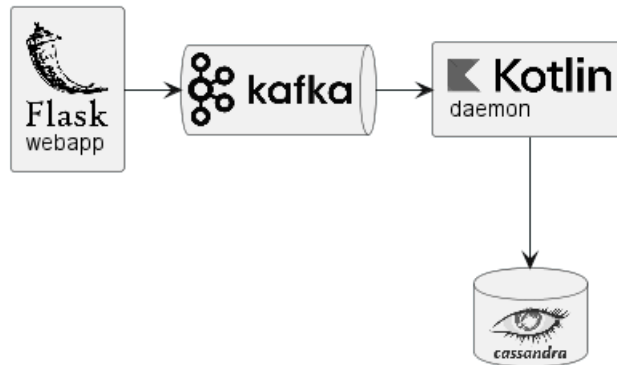

```

@startuml
scale 0.7
!include <logos/apple-pay>
!include <logos/dinersclub>
!include <logos/discover>
!include <logos/google-pay>
!include <logos/jcb>
!include <logos/maestro>
!include <logos/mastercard>
!include <logos/paypal>
!include <logos/unionpay>
!include <logos/visaelectron>
!include <logos/visa>
' ...
  
```

```

title Gil Barbara's logos example - **Payment Scheme**
  
```

```

actor customer
rectangle "<$apple-pay>" as ap
rectangle "<$dinersclub>" as dc
rectangle "<$discover>" as d
rectangle "<$google-pay>" as gp
rectangle "<$jcb>" as j
rectangle "<$maestro>" as ma
rectangle "<$mastercard>" as m
rectangle "<$paypal>" as p
rectangle "<$unionpay>" as up
rectangle "<$visa>" as v
rectangle "<$visaelectron>" as ve
rectangle "... " as etc
  
```

```

customer --> ap
customer ---> dc
customer --> d
customer ---> gp
customer --> j
customer ---> ma
customer --> m
customer ---> p
customer --> up
customer ---> v
customer --> ve
customer ---> etc
  
```



```
@enduml
```

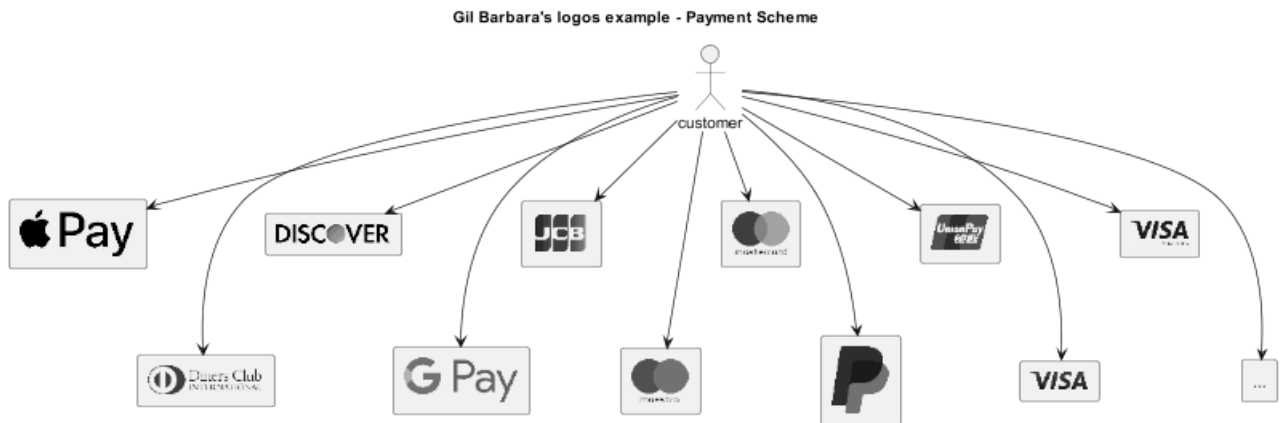

27.12 Office [office]

Type	Link
stdlib	https://github.com/plantuml/plantuml-stdlib/tree/master/office
src	https://github.com/Roemer/plantuml-office
orig	

There are sprites (*.puml) and colored png icons available. Be aware that the sprites are all only monochrome even if they have a color in their name (due to automatically generating the files). You can either color the sprites with the macro (see examples below) or directly use the fully colored pngs. See the following examples on how to use the sprites, the pngs and the macros.

Example of usage:

```

@startuml
!include <tupadr3/common>

!include <office/Servers/database_server>
!include <office/Servers/application_server>
!include <office/Concepts/firewall_orange>
!include <office/Clouds/cloud_disaster_red>

title Office Icons Example

package "Sprites" {
    OFF_DATABASE_SERVER(db,DB)
    OFF_APPLICATION_SERVER(app,App-Server)
    OFF_FIREWALL_ORANGE(fw,Firewall)
    OFF_CLOUD_DISASTER_RED(cloud,Cloud)
    db <-> app
    app <-> fw
    fw <.left.> cloud
}
@enduml

```



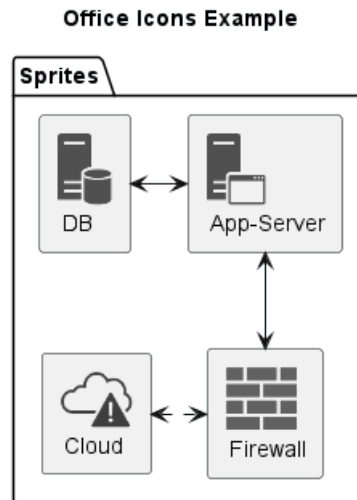

```

@startuml
!include <tupadr3/common>

!include <office/servers/database_server>
!include <office/servers/application_server>
!include <office/Concepts/firewall_orange>
!include <office/Clouds/cloud_disaster_red>

' Used to center the label under the images
skinparam defaultTextAlignment center

title Extended Office Icons Example

package "Use sprite directly" {
    [Some <$cloud_disaster_red> object]
}

package "Different macro usages" {
    OFF_CLOUD_DISASTER_RED(cloud1)
    OFF_CLOUD_DISASTER_RED(cloud2,Default with text)
    OFF_CLOUD_DISASTER_RED(cloud3,Other shape,Folder)
    OFF_CLOUD_DISASTER_RED(cloud4,Even another shape,Database)
    OFF_CLOUD_DISASTER_RED(cloud5,Colored,Rectangle, red)
    OFF_CLOUD_DISASTER_RED(cloud6,Colored background) #red
}
@enduml

```

Extended Office Icons Example

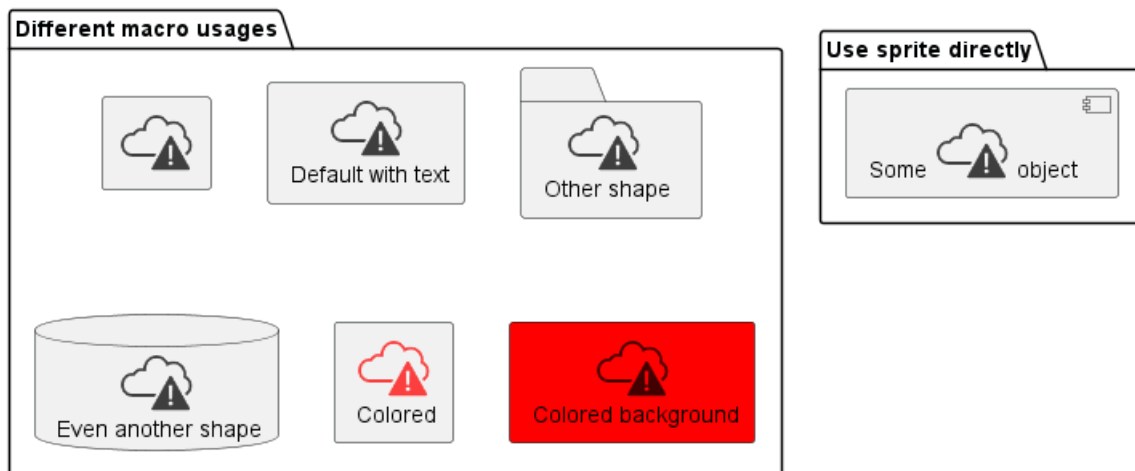

27.13 Open Security Architecture (OSA) [osa]

Type	Link
stdlib	https://github.com/plantuml/plantuml-stdlib/tree/master/osa
src	https://github.com/Crashedmind/PlantUML-opensecurityarchitecture-icons
orig	https://www.opensecurityarchitecture.org

```
@startuml
```

```
'Adapted from https://github.com/Crashedmind/PlantUML-opensecurityarchitecture-icons/blob/master/all
scale .5
```

```
!include <osa/arrow/green/left/left>
!include <osa/arrow/yellow/right/right>
!include <osa/awareness/awareness>
!include <osa/contract/contract>
!include <osa/database/database>
!include <osa/desktop/desktop>
!include <osa/desktop/imac/imac>
!include <osa/device_music/device_music>
!include <osa/device_scanner/device_scanner>
!include <osa/device_usb/device_usb>
!include <osa/device_wireless_router/device_wireless_router>
!include <osa/disposal/disposal>
!include <osa/drive_optical/drive_optical>
!include <osa/firewall/firewall>
!include <osa/hub/hub>
!include <osa/ics/drive/drive>
!include <osa/ics/plc/plc>
!include <osa/ics/thermometer/thermometer>
!include <osa/id/card/card>
!include <osa/laptop/laptop>
!include <osa/lifecycle/lifecycle>
!include <osa/lightning/lightning>
!include <osa/media_flash/media_flash>
!include <osa/media_optical/media_optical>
!include <osa/media_tape/media_tape>
!include <osa/mobile/pda/pda>
!include <osa/padlock/padlock>
!include <osa/printer/printer>
!include <osa/site_branch/site_branch>
!include <osa/site_factory/site_factory>
!include <osa/vpn/vpn>
```



```

!include <osa/wireless/network/network>

rectangle "OSA" {
rectangle "Left:\n <$left>"
rectangle "Right:\n <$right>"
rectangle "Awareness:\n <$awareness>"
rectangle "Contract:\n <$contract>"
rectangle "Database:\n <$database>"
rectangle "Desktop:\n <$desktop>"
rectangle "Imac:\n <$imac>"
rectangle "Device_music:\n <$device_music>"
rectangle "Device_scanner:\n <$device_scanner>"
rectangle "Device_usb:\n <$device_usb>"
rectangle "Device_wireless_router:\n <$device_wireless_router>"
rectangle "Disposal:\n <$disposal>"
rectangle "Drive_optical:\n <$drive_optical>"
rectangle "Firewall:\n <$firewall>"
rectangle "Hub:\n <$hub>"
rectangle "Drive:\n <$drive>"
rectangle "Plc:\n <$plc>"
rectangle "Thermometer:\n <$thermometer>"
rectangle "Card:\n <$card>"
rectangle "Laptop:\n <$laptop>"
rectangle "Lifecycle:\n <$lifecycle>"
rectangle "Lightning:\n <$lightning>"
rectangle "Media_flash:\n <$media_flash>"
rectangle "Media_optical:\n <$media_optical>"
rectangle "Media_tape:\n <$media_tape>"
rectangle "Pda:\n <$pda>"
rectangle "Padlock:\n <$padlock>"
rectangle "Printer:\n <$printer>"
rectangle "Site_branch:\n <$site_branch>"
rectangle "Site_factory:\n <$site_factory>"
rectangle "Vpn:\n <$vpn>"
rectangle "Network:\n <$network>"
}
@enduml

```



```

@startuml
scale .5
!include <osa/user/audit/audit>
'beware of 'hat-sprite'
!include <osa/user/black/hat/hat-sprite>
!include <osa/user/blue/blue>
!include <osa/user/blue/security/specialist/specialist>
!include <osa/user/blue/sysadmin/sysadmin>
!include <osa/user/blue/tester/tester>
!include <osa/user/blue/tie/tie>
!include <osa/user/green/architect/architect>
!include <osa/user/green/business/manager/manager>
!include <osa/user/green/developer/developer>
!include <osa/user/green/green>
!include <osa/user/green/operations/operations>
!include <osa/user/green/project/manager/manager>
!include <osa/user/green/service/manager/manager>
!include <osa/user/green/warning/warning>
!include <osa/user/large/group/group>
!include <osa/users/blue/green/green>
!include <osa/user/white/hat/hat>

```

```
listsprites
```



@enduml

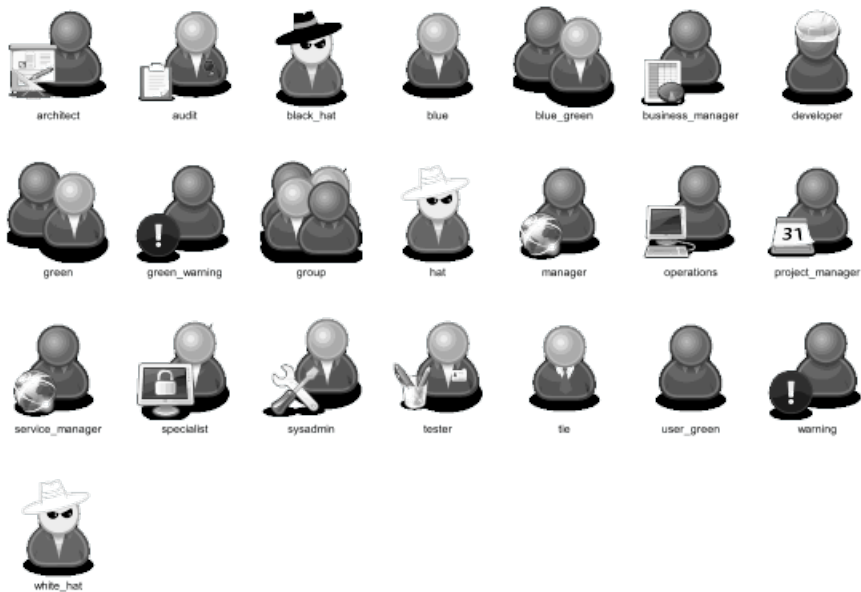

27.14 Tupadr3 library [tupadr3]

Type	Link
stdlib	https://github.com/plantuml/plantuml-stdlib/tree/master/tupadr3
src	https://github.com/tupadr3/plantuml-icon-font-sprites
orig	https://github.com/tupadr3/plantuml-icon-font-sprites#icon-sets

This library contains several libraries of icons (including Devicons and Font Awesome).

Use it by including the file that contains the sprite, eg: `!include <font-awesome/align_center>`.
When imported, you can use the sprite as normally you would, using `<$sprite_name>`.

You may also include the `common.puml` file, eg: `!include <font-awesome/common>`, which contains helper macros defined. With the `common.puml` imported, you can use the `NAME_OF_SPRITE(parameters...)` macro.

Example of usage:

```
@startuml
!include <tupadr3/common>
!include <tupadr3/font-awesome/server>
!include <tupadr3/font-awesome/database>

title Styling example

FA_SERVER(web1,web1) #Green
FA_SERVER(web2,web2) #Yellow
FA_SERVER(web3,web3) #Blue
FA_SERVER(web4,web4) #YellowGreen

FA_DATABASE(db1,LIVE,database,white) #RoyalBlue
FA_DATABASE(db2,SPARE,database) #Red

db1 <--> db2

web1 <--> db1
web2 <--> db1
web3 <--> db1
web4 <--> db1
```



```
@enduml
```

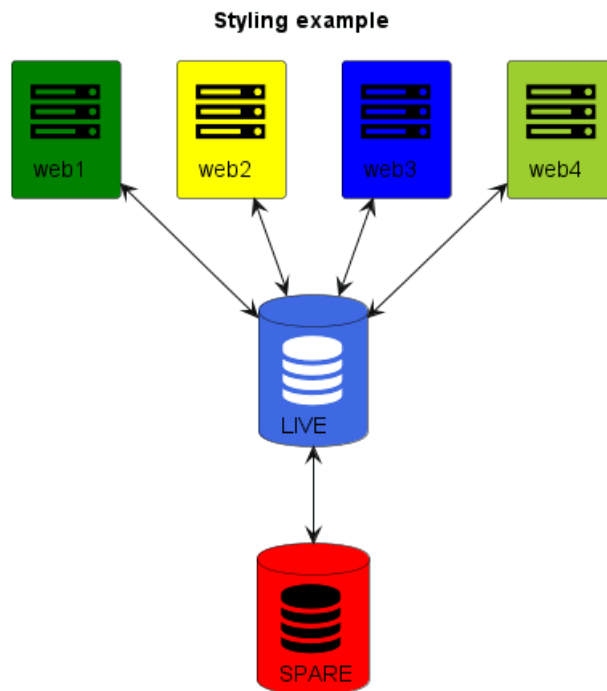

```
@startuml
!include <tupadr3/common>
!include <tupadr3/devicons/mysql>

DEV_MYSQL(db1)
DEV_MYSQL(db2,label of db2)
DEV_MYSQL(db3,label of db3,database)
DEV_MYSQL(db4,label of db4,database,red) #DeepSkyBlue
@enduml
```

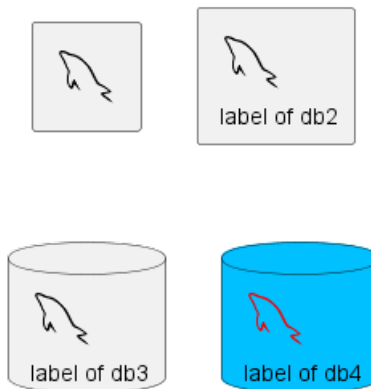

27.15 Bibliothèque AWS

Type	Link
stdlib	https://github.com/plantuml/plantuml-stdlib/tree/master/aws
src	https://github.com/milo-minderbinder/AWS-PlantUML
orig	https://aws.amazon.com/en/architecture/icons/

Warning: We are thinking about deprecating this library.

So you should probably use `<awslib>` instead (see above).



hr

La bibliothèque AWS est composée des icônes AWS en deux tailles différentes.

Pour l'utiliser, il vous faut inclure le fichier qui contient le sprite (ex: `!include <aws/Storage/AmazonS3/AmazonS3>`). Une fois importé, vous pouvez utiliser le sprite normalement en l'appelant de la manière suivante `<$nom_du_sprite>`.

Vous pouvez aussi inclure le fichier `common.puml` qui contient plusieurs macros utiles avec la commande `!include <aws/common>`. Avec ce fichier importé, vous pouvez par exemple appeler la macro `"NOM_DU_SPRITE(parametres...)`.

Exemple d'utilisation :

```
@startuml
!include <aws/common>
!include <aws/Storage/AmazonS3/AmazonS3>
!include <aws/Storage/AmazonS3/bucket/bucket>
```

```
AMAZONS3(s3_internal)
AMAZONS3(s3_partner, "Vendor's S3")
s3_internal <- s3_partner
@enduml
```

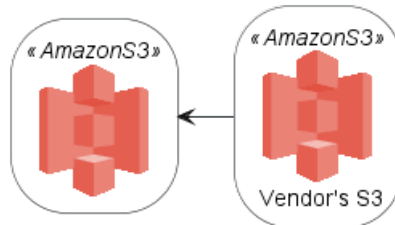

Contents

1	Diagramme de séquence	1
1.1	Exemples de base	1
1.2	Déclaration d'un participant	2
1.3	Declaring participant on multiline	4
1.4	Caractères non alphanumérique dans les participants	4
1.5	Message à soi-même	5
1.6	Alignement du texte	5
1.6.1	Texte du message de réponse sous la flèche	5
1.7	Autre style de flèches	6
1.8	Changer la couleur des flèches	6
1.9	Numérotation séquentielle des messages	7
1.10	Titre, en-tête et pied de page de la page	10
1.11	Découper un diagramme	11
1.12	Regrouper les messages (cadres UML)	11
1.13	Étiquette secondaire de groupe	12
1.14	Note sur les messages	13
1.15	Encore plus de notes	14
1.16	Changer l'aspect des notes	15
1.17	Note sur tous les participants [à travers]	15
1.18	Plusieurs notes alignées au même niveau [/]	16
1.19	Créole (langage de balisage léger) et HTML	17
1.20	Diviseur ou séparateur	18
1.21	Référence	18
1.22	Retard	19
1.23	Habillage du texte	19
1.24	Séparation verticale	20
1.25	Lignes de vie	20
1.26	Retour	22
1.27	Création d'un participant	22
1.28	Syntaxe raccourcie pour l'activation, la désactivation, la création	23
1.29	Messages entrant et sortant	24
1.30	Flèches courtes pour les messages entrants et sortants	25
1.31	Anchors and Duration	26
1.32	Stéréotypes et décoration	27
1.33	Plus d'information sur les titres	28
1.34	Cadre pour les participants	29
1.35	Supprimer les participants en pied de page	29
1.36	Personnalisation	30
1.37	Changer le padding	32
1.38	Appendix: Examples of all arrow type	33
1.38.1	Normal arrow	33
1.38.2	Itself arrow	34
1.38.3	Incoming and outgoing messages (with '[' , ']')	35
1.38.4	Incoming messages (with '[')	35
1.38.5	Outgoing messages (with ']')	37
1.38.6	Short incoming and outgoing messages (with '?')	38
1.38.7	Short incoming (with '?')	38
1.38.8	Short outgoing (with '?')	39
1.39	SkinParameter spécifique	41
1.39.1	Par défaut	41
1.39.2	LifelineStrategy	41
1.39.3	style strictuml	41
1.40	Masquer un participant non lié	42
1.41	Colorier un groupe de message	42
1.42	Mainframe	43
1.43	Slanted or odd arrows	43



2	Diagramme de cas d'utilisation	46
2.1	Cas d'utilisation	46
2.2	Acteurs	46
2.3	Change Actor style	47
2.3.1	Stick man (<i>by default</i>)	47
2.3.2	Awesome man	47
2.3.3	Hollow man	48
2.4	Description des cas d'utilisation	48
2.5	Utiliser un package	48
2.6	Exemples très simples	50
2.7	Héritage	50
2.8	Notes	51
2.9	Stéréotypes	52
2.10	Changer les directions des flèches	52
2.11	Découper les diagrammes	53
2.12	De droite à gauche	54
2.13	La commande Skinparam	54
2.14	Exemple complet	55
2.15	Business Use Case	56
2.15.1	Business Use Case	56
2.15.2	Acteur commercial	56
2.16	Modifier la couleur et le style des flèches (style en ligne)	57
2.17	Modifier la couleur et le style d'un élément (style en ligne)	57
2.18	Display JSON Data on Usecase diagram	58
2.18.1	Simple example	58
3	Diagramme de classes	59
3.1	Déclaration d'un élément	59
3.2	Relations entre classes	59
3.3	Libellés sur les relations	61
3.4	Caractères non alphabétiques	61
3.5	Définir les méthodes	62
3.6	Définition de la visibilité	63
3.7	Abstrait et statique	64
3.8	Corps de classe avancé	64
3.9	Notes et stéréotypes	65
3.10	Plus de notes	66
3.11	Note sur un champ (champ, attribut, membre) ou une méthode	67
3.11.1	Note sur un champ ou une méthode	67
3.11.2	Note sur une méthode de même nom	67
3.12	Note sur les liens	68
3.13	Classe et interface abstraites	68
3.14	Masquer les attributs et les méthodes	69
3.15	Masquer les classes	70
3.16	Supprimer des classes	71
3.17	Hide, Remove or Restore tagged element or wildcard	71
3.18	Masquer ou supprimer une classe non liée	73
3.19	Utilisation de la généricité	74
3.20	Caractère spécial	74
3.21	Packages	74
3.22	Modèle de paquet	75
3.23	Les espaces de nommage	76
3.24	Creation automatique d'espace de nommage	77
3.25	Interface boucle	78
3.26	Changer la direction	78
3.27	Classes d'association	80
3.28	Association sur la même classe	81
3.29	Personnalisation	81



3.30	Stéréotypes Personnalisés	82
3.31	Dégradé de couleurs	82
3.32	Aide pour la mise en page	83
3.33	Découper les grands diagrammes	84
3.34	Extension et implementation [extends, implements]	85
3.35	Relations entre crochets (liens ou flèches) style	85
3.35.1	Style de ligne	85
3.35.2	Couleur de ligne	86
3.35.3	Épaisseur de ligne	87
3.35.4	Mélange	88
3.36	Modifier la couleur et le style d'une relation (lien ou flèche) (style en ligne)	88
3.37	Modifier la couleur et le style d'une classe (style en ligne)	89
3.38	Flèches de/vers les membres de la classe	90
3.39	Regroupement de flèche d'héritage	91
3.39.1	GroupInheritance 1 (pas de regroupement)	91
3.39.2	GroupInheritance 2 (regroupement à partir de 2)	91
3.39.3	GroupInheritance 3 (regroupement uniquement à partir de 3)	92
3.39.4	GroupInheritance 4 (regroupement uniquement à partir de 4)	92
3.40	Display JSON Data on Class or Object diagram	93
3.40.1	Simple example	93
3.41	Packages and Namespaces Enhancement	94
4	Diagramme d'objets	96
4.1	Définition des objets	96
4.2	Relations entre les objets	96
4.3	Association d'objets	97
4.4	Ajout de champs	97
4.5	Caractéristiques communes avec les diagrammes de classes	98
4.6	Table de correspondance ou tableau associatif	98
4.7	Program (or project) evaluation and review technique (PERT) with map	99
4.8	Display JSON Data on Class or Object diagram	100
4.8.1	Simple example	100
5	Diagrammes d'activité (ancienne syntaxe)	102
5.1	Action simple	102
5.2	Texte sur les flèches	102
5.3	Changer la direction des flèches	103
5.4	Branches	103
5.5	Encore des branches	104
5.6	Synchronisation	105
5.7	Description détaillée	106
5.8	Notes	107
5.9	Partition	107
5.10	Paramètre de thème	108
5.11	Octogone	109
5.12	Exemple complet	109
6	Diagramme d'activité (nouvelle syntaxe)	112
6.0.1	Avantages de la nouvelle syntaxe	112
6.0.2	Transition vers la nouvelle syntaxe	112
6.1	Action simple	112
6.2	Départ/Arrêt [start, stop, end]	112
6.3	Conditionnel [if, then, else]	113
6.3.1	Plusieurs conditions (en mode horizontal)	114
6.3.2	Plusieurs conditions (en mode vertical)	115
6.4	Switch and case [switch, case, endswitch]	116
6.5	Arrêt après une action au sein d'une condition [kill, detach]	117
6.6	Boucle de répétition [repeat, repeatwhile, backward]	118
6.7	Interruption d'une boucle [break]	119



6.8	Goto and Label Processing [label, goto]	120
6.9	Boucle « tant que » [while]	121
6.10	Traitement parallèle [fork, fork again, end fork, end merge]	122
6.10.1	Simple fork	122
6.10.2	fork avec fusion finale	122
6.10.3	Label sur end fork (ou UML joinspec)	123
6.10.4	Autre exemple	124
6.11	Traitement fractionné	125
6.11.1	Split	125
6.11.2	Fractionnement de l'entrée (multidébut)	125
6.11.3	Fractionnement de la sortie (plusieurs extrémités)	126
6.12	Notes	127
6.13	Couleurs	129
6.14	Lignes sans pointe de flèches	130
6.15	Flèches	130
6.16	Connecteurs	131
6.17	Connecteurs en couleur	131
6.18	Regroupement ou partition	132
6.18.1	Groupe	132
6.18.2	Partition	133
6.18.3	Groupe, partition, paquet, rectangle ou carte	135
6.19	Swimlanes	136
6.20	Détacher ou arrêter [detach, kill]	139
6.21	SDL (Specification and Description Language)	140
6.22	Exemple complet	141
6.23	Style de condition	143
6.23.1	Style intérieur (par défaut)	143
6.23.2	Style diamant	144
6.23.3	Style InsideDiamond (ou Foo1)	145
6.24	Style de fin de condition	146
6.24.1	Style diamant (par défaut)	146
6.24.2	Style ligne horizontale (hline)	147
6.25	Avec le style (global)	148
6.25.1	Sans style (par défaut)	148
6.25.2	Avec style	148
7	Diagrammes de composants	151
7.1	Composants	151
7.2	Interfaces	151
7.3	Exemple de base	152
7.4	Utilisation des notes	152
7.5	Regroupement de composants	153
7.6	Changement de direction des flèches	154
7.7	Utiliser la notation UML2	156
7.8	Utiliser la notation UML1	156
7.9	Utiliser le style rectangle (supprime toute notation UML)	156
7.10	Description longue	157
7.11	Couleurs individuelles	157
7.12	Sprites et stéréotypes	157
7.13	Skinparam	158
7.14	Paramètre de style spécifique	159
7.14.1	componentStyle	159
7.15	Masquer ou supprimer un composant non lié	161
7.16	Masquer, supprimer ou restaurer un composant balisé ou un joker	162
7.17	Display JSON Data on Component diagram	163
7.17.1	Simple exemple	163
7.18	Port [port, portIn, portOut]	164
7.18.1	Port	164



7.18.2	PortIn	165
7.18.3	PortOut	165
7.18.4	Mixing PortIn & PortOut	166
8	Diagramme de déploiement	168
8.1	Déclarer un élément	168
8.2	Declaring element (using short form)	170
8.2.1	Actor	170
8.2.2	Component	171
8.2.3	Interface	171
8.2.4	Usecase	171
8.3	Linking or arrow	171
8.4	Bracketed arrow style	174
8.4.1	Line style	174
8.4.2	Line color	175
8.4.3	Line thickness	175
8.4.4	Mix	176
8.5	Change arrow color and style (inline style)	176
8.6	Change element color and style (inline style)	177
8.7	Nestable elements	178
8.8	Packages and nested elements	178
8.8.1	Example with one level	178
8.8.2	Other example	179
8.8.3	Full nesting	180
8.9	Alias	184
8.9.1	Simple alias with as	184
8.9.2	Examples of long alias	185
8.10	Round corner	187
8.11	Specific SkinParameter	187
8.11.1	roundCorner	187
8.12	Appendix: All type of arrow line	188
8.13	Appendix: All type of arrow head or '0' arrow	189
8.13.1	Type of arrow head	189
8.13.2	Type of '0' arrow or circle arrow	190
8.14	Appendix: Test of inline style on all element	191
8.14.1	Simple element	191
8.14.2	Nested element	192
8.14.3	Without sub-element	192
8.14.4	With sub-element	193
8.15	Appendix: Test of style on all element	194
8.15.1	Simple element	194
8.15.2	Global style (on componentDiagram)	194
8.15.3	Style for each element	195
8.15.4	Nested element (without level)	199
8.15.5	Global style (on componentDiagram)	199
8.15.6	Style for each nested element	199
8.15.7	Nested element (with one level)	201
8.15.8	Global style (on componentDiagram)	201
8.15.9	Style for each nested element	202
8.16	Appendix: Test of stereotype with style on all element	205
8.16.1	Simple element	205
8.17	Display JSON Data on Deployment diagram	206
8.17.1	Simple example	206
8.18	Mixing Deployment (Usecase, Component, Deployment) element within a Class or Object diagram	207
8.18.1	Mixing all elements	207
8.19	Port [port, portIn, portOut]	209
8.19.1	Port	209



8.19.2	PortIn	210
8.19.3	PortOut	210
8.19.4	Mixing PortIn & PortOut	211
9	Diagrammes d'état	213
9.1	Exemple simple	213
9.2	Autre rendu	213
9.3	État composite	214
9.3.1	Sous-état interne	214
9.3.2	Lien entre sous-états	215
9.4	Nom long	216
9.5	Historique de sous-état [[H], [H*]]	217
9.6	États parallèles [fork, join]	217
9.7	États concurrents [-,]	218
9.7.1	Séparateur horizontal --	218
9.7.2	Séparateur vertical 	219
9.8	Conditionnel [choice]	220
9.9	Exemple avec tous les stéréotypes [choice, fork, join, end]	220
9.10	Petits cercles [entryPoint, exitPoint]	221
9.11	Petits carrés [inputPin, outputPin]	222
9.12	Multiplés petits carrés [expansionInput, expansionOutput]	223
9.13	Direction des flèches	224
9.14	Changer la couleur ou le style des flèches	225
9.15	Note	225
9.16	Note sur un lien	226
9.17	Plus de notes	226
9.18	Changer les couleurs localement [Inline color]	227
9.19	Skinparam	228
9.19.1	Test de tous les skinparam spécifiques aux diagrammes d'état:	229
9.20	Changement de style	229
9.21	Modifier la couleur et le style d'un état (style en ligne)	230
9.22	Alias	232
9.23	Display JSON Data on State diagram	233
9.23.1	Simple example	233
10	Diagramme de temps	234
10.1	Définitions des participants	234
10.2	Horloge et signaux binaires	234
10.3	Ajout de messages	235
10.4	Référence relative de temps	235
10.5	Points d'ancrage	236
10.6	Définition participant par participant	237
10.7	Choix du zoom	237
10.8	État initial	237
10.9	État complexe	238
10.10	Hidden state	239
10.11	Masquer l'axe du temps	239
10.12	Utilisation de l'heure et de la date	240
10.13	Ajout de contraintes	241
10.14	Période surlignée	241
10.15	Using notes	242
10.16	Ajout de textes	243
10.17	Exemple complet	244
10.18	Exemple numérique	245
10.19	Ajout de couleur	246
10.20	Using (global) style	247
10.20.1	Without style (<i>by default</i>)	247
10.20.2	With style	247
10.21	Applying Colors to specific lines	248

10.22 Compact mode	249
10.22.1 By default	249
10.22.2 Global mode with <code>mode compact</code>	250
10.22.3 Local mode with only <code>compact</code> on element	250
11 Display JSON Data	252
11.1 Complex example	252
11.2 Highlight parts	253
11.3 Using different styles for highlight	253
11.4 JSON basic element	254
11.4.1 Synthesis of all JSON basic element	254
11.5 JSON array or table	255
11.5.1 Array type	255
11.5.2 Minimal array or table	256
11.5.3 Number array	256
11.5.4 String array	256
11.5.5 Boolean array	256
11.6 JSON numbers	256
11.7 JSON strings	257
11.7.1 JSON Unicode	257
11.7.2 JSON two-character escape sequence	257
11.8 Minimal JSON examples	258
11.9 Empty table or list	259
11.10 Using (global) style	259
11.10.1 Without style (<i>by default</i>)	259
11.10.2 With style	260
11.11 Display JSON Data on Class or Object diagram	261
11.11.1 Simple example	261
11.11.2 Complex example: with all JSON basic element	261
11.12 Display JSON Data on Deployment (Usecase, Component, Deployment) diagram	262
11.12.1 Simple example	262
11.13 Display JSON Data on State diagram	263
11.13.1 Simple example	263
12 Display YAML Data	265
12.1 Complex example	265
12.2 Specific key (with symbols or unicode)	266
12.3 Highlight parts	266
12.3.1 Normal style	266
12.3.2 Customised style	267
12.4 Using different styles for highlight	267
12.5 Using (global) style	268
12.5.1 Without style (<i>by default</i>)	268
12.5.2 With style	269
13 nwdiag	271
13.1 Diagramme simple	271
13.1.1 Définir un réseau	271
13.1.2 Définir certains éléments ou serveurs sur un réseau	271
13.1.3 Exemple complet	271
13.2 Define multiple addresses	272
13.3 Grouping nodes	273
13.3.1 Define group inside network definitions	273
13.3.2 Define group outside of network definitions	273
13.3.3 Define several groups on same network	274
13.3.4 Example with 2 group	274
13.3.5 Example with 3 groups	275
13.4 Extended Syntax (for network or group)	276
13.4.1 Network	276



13.4.2	Group	277
13.5	Using Sprites	278
13.6	Using OpenIconic	279
13.7	Same nodes on more than two networks	280
13.8	Peer networks	281
13.9	Peer networks and group	281
13.9.1	Without group	281
13.9.2	Group on first	282
13.9.3	Group on second	283
13.9.4	Group on third	284
13.10	Add title, caption, header, footer or legend on network diagram	285
13.11	With or without shadow	286
13.11.1	With shadow (by default)	286
13.11.2	Without shadow	286
13.12	Change width of the networks	287
13.13	Other internal networks	290
13.14	Using (global) style	291
13.14.1	Without style (<i>by default</i>)	291
13.14.2	With style	292
13.15	Appendix: Test of all shapes on Network diagram (nwdiag)	293
14	Salt (Wireframe)	296
14.1	Composants de base	296
14.2	Text area	296
14.3	Ouvrir, fermer une liste déroulante	297
14.4	Utilisation de la grille [et #, !, -, +]	298
14.5	Regroupement de champs	298
14.6	Utilisation des séparateurs	298
14.7	Arbre (structure arborescente) [T]	299
14.8	Arbre et Tableau [T]	299
14.9	Accolades délimitantes [{, }]	301
14.10	Ajout d'onglet [/]	301
14.11	Utilisation de menu [*]	302
14.12	Tableaux avancés	303
14.13	Barres de défilement [S, SI, S-]	304
14.14	Couleurs	305
14.15	Creole on Salt	305
14.16	Pseudo sprite [«, »]	307
14.17	OpenIconic	307
14.18	Ajouter un titre, un en-tête, un pied de page, une légende	308
14.19	Zoom, DPI	309
14.19.1	Sans zoom (par défaut)	309
14.19.2	Scale	309
14.19.3	DPI	309
14.20	Include Salt "on activity diagram"	310
14.21	Include salt "on while condition of activity diagram"	312
14.22	Include salt "on repeat while condition of activity diagram"	313
14.23	Skinparam	314
14.24	Style	315
15	Diagramme Archimate	316
15.1	Mot-clé Archimate	316
15.2	Jonctions Archimate	316
15.3	Exemple 1	317
15.4	Exemple 2	318
15.5	Liste des sprites possibles	319
15.6	ArchiMate Macros	319
15.6.1	Archimate Macros and Library	319
15.6.2	Archimate elements	319



15.6.3	Archimate relationships	320
15.6.4	Appendice: Examples of all Archimate RelationTypes	321
16	Diagramme de Gantt	325
16.1	Déclaration des tâches	325
16.1.1	Durée	325
16.1.2	Start	325
16.1.3	End	325
16.1.4	Début/Fin	326
16.2	Déclaration sur une ligne (avec la conjonction et)	326
16.3	Ajout de contraintes	327
16.4	Noms courts (avec : as)	327
16.5	Choix des couleurs	327
16.6	Complétion d'une tâche	328
16.6.1	Ajout du pourcentage d'achèvement	328
16.6.2	Changer la couleur de l'achèvement (par style)	328
16.7	Jalon (avec le verbe : happen)	329
16.7.1	Jalon relatif (avec utilisation de contraintes sur des tâches)	329
16.7.2	Jalon absolu (avec utilisation d'un date fixe)	329
16.7.3	Jalon de fin maximale de tâches	330
16.8	Lien hypertexte	330
16.9	Calendrier	330
16.10	Journées en couleur	331
16.11	Changement d'échelle	331
16.11.1	Daily (<i>par défaut</i>)	331
16.11.2	Hebdomadaire	332
16.11.3	Mensuel	332
16.11.4	Trimestriel	333
16.11.5	Annuel	333
16.12	Zoom (exemple pour toutes les échelles)	334
16.12.1	Zoom sur l'échelle hebdomadaire	334
16.12.2	Sans zoom	334
16.12.3	Avec zoom	334
16.12.4	Zoom sur l'échelle hebdomadaire	335
16.12.5	Sans zoom	335
16.12.6	Avec zoom	335
16.12.7	Zoom sur l'échelle mensuelle	336
16.12.8	Sans zoom	336
16.12.9	Avec zoom	336
16.12.10	Zoom sur l'échelle trimestrielle	336
16.12.11	Sans zoom	336
16.12.12	Avec zoom	337
16.12.13	Zoom sur l'échelle annuelle	337
16.12.14	Sans zoom	337
16.12.15	Avec zoom	337
16.13	Weekscale with Weeknumbers or Calendar Date	338
16.13.1	With Weeknumbers (<i>by default</i>)	338
16.13.2	With Calendar Date	338
16.14	Jours non travaillés	338
16.15	Définition d'une semaine en fonction des jours fermés	339
16.16	Working days	340
16.17	Succession des tâches simplifiée et dépendances	340
16.18	Travailler avec des ressources	341
16.19	Hide resources	341
16.19.1	Without any hiding (by default)	341
16.19.2	Hide resources names	342
16.19.3	Hide resources footbox	342
16.19.4	Hide the both (resources names and resources footbox)	342

16.20	Séparateur	343
16.21	Vertical Separator	343
16.22	Exemple plus complexe	343
16.23	Comments	344
16.24	Avec style	344
16.24.1	Sans style (par défaut)	344
16.24.2	Avec style	345
16.24.3	Avec style (exemple complet)	346
16.24.4	Nettoyer le style	348
16.25	Ajouter des notes	349
16.26	Pause des tâches	351
16.27	Modifier les couleurs des liens	352
16.28	Tâches ou jalons sur la même ligne	353
16.29	Mise en avant du jour courant	353
16.30	Tâche entre deux jalons	353
16.31	Grammar and verbal form	354
16.32	Ajouter un titre, un en-tête, un pied de page, une légende ou un sous-titre	354
16.33	Suppression de l'encadré de pied de page (exemple pour toutes les échelles)	354
16.34	Langue du calendrier	356
16.34.1	Anglais (<i>en, par défaut</i>)	356
16.34.2	Français (fr)	357
16.34.3	Allemand (de)	357
16.34.4	Japonais (ja)	358
16.34.5	Chinois (zh)	358
16.34.6	Coréen (ko)	358
16.35	Supprimer des tâches ou des jalons	359
16.36	Start a project, a task or a milestone a number of days before or after today	359
16.37	Change Label position	360
16.37.1	The labels are near elements (<i>by default</i>)	360
16.37.2	Label on first column	360
16.37.3	Label on last column	361
17	MindMap	363
17.1	Syntaxe OrgMode	363
17.2	Syntaxe Markdown	363
17.3	Notation arithmétique [+ , -]	364
17.4	Multilignes	364
17.5	Multiroot Mindmap	365
17.6	Couleurs	366
17.6.1	Avec couleur en ligne	366
17.6.2	Avec couleur de style	367
17.7	Masquer les bordures [□]	368
17.8	Diagramme multi-directionnel	370
17.9	Exemple complet	370
17.10	Changement de style	371
17.10.1	noeud, profondeur	371
17.10.2	sans boîte	372
17.11	Word Wrap	372
17.12	Creole on Mindmap diagram	373
18	Work Breakdown Structure (WBS)	376
18.1	Syntaxe OrgMode	376
18.2	Changement de direction [< , >]	376
18.3	Notation arithmétique [+ , -]	377
18.4	Multi-lignes	378
18.5	Masquer les bordures [□]	378
18.6	Colors (with inline or style color)	379
18.7	Using style	380
18.8	Word Wrap	382



18.9	Add arrows between WBS elements	383
18.10	Creole on WBS diagram	384
19	Mathématiques	387
19.1	Diagramme indépendant	388
19.2	Comment cela fonctionne ?	388
20	Entity Relationship Diagram	389
20.1	Information Engineering Relations	389
20.2	Entities	389
20.3	Complete Example	390
21	Commandes communes dans PlantUML	392
21.0.1	Global Elements	392
21.0.2	Description de la syntaxe créole	392
21.0.3	Commande de contrôle du style	392
21.1	Comments	392
21.1.1	Simple comment	392
21.1.2	Block comment	392
21.1.3	Full example	393
21.2	Zoom	393
21.3	Title	394
21.4	Caption	395
21.5	Footer and header	395
21.6	Legend the diagram	396
21.7	Appendix: Examples on all diagram	396
21.7.1	Activity	396
21.7.2	Archimate	397
21.7.3	Class	398
21.7.4	Component, Deployment, Use-Case	398
21.7.5	Gantt project planning	399
21.7.6	Object	399
21.7.7	MindMap	400
21.7.8	Network (nwdiag)	401
21.7.9	Sequence	401
21.7.10	State	402
21.7.11	Timing	403
21.7.12	Work Breakdown Structure (WBS)	403
21.7.13	Wireframe (SALT)	404
21.8	Appendix: Examples on all diagram with style	405
21.8.1	Activity	405
21.8.2	Archimate	407
21.8.3	Class	408
21.8.4	Component, Deployment, Use-Case	410
21.8.5	Gantt project planning	411
21.8.6	Object	413
21.8.7	MindMap	414
21.8.8	Network (nwdiag)	415
21.8.9	Sequence	417
21.8.10	State	418
21.8.11	Timing	420
21.8.12	Work Breakdown Structure (WBS)	421
21.8.13	Wireframe (SALT)	422
21.9	Mainframe	423
21.10	Appendix: Examples of Mainframe on all diagram	424
21.10.1	Activity	424
21.10.2	Archimate	424
21.10.3	Class	425
21.10.4	Component, Deployment, Use-Case	425



21.10.5 Gantt project planning	425
21.10.6 Object	426
21.10.7 MindMap	426
21.10.8 Network (nwdiag)	426
21.10.9 Sequence	427
21.10.10 State	427
21.10.11 Timing	427
21.10.12 Work Breakdown Structure (WBS)	428
21.10.13 Wireframe (SALT)	428
21.11 Appendix: Examples of title, header, footer, caption, legend and mainframe on all diagram	429
21.11.1 Activity	429
21.11.2 Archimate	429
21.11.3 Class	430
21.11.4 Component, Deployment, Use-Case	431
21.11.5 Gantt project planning	431
21.11.6 Object	432
21.11.7 MindMap	433
21.11.8 Network (nwdiag)	433
21.11.9 Sequence	434
21.11.10 State	435
21.11.11 Timing	435
21.11.12 Work Breakdown Structure (WBS)	436
21.11.13 Wireframe (SALT)	437
22 Créole	439
22.1 Texte mis en évidence	439
22.2 Listes	439
22.3 Caractère d'échappement	440
22.4 Entêtes	440
22.5 Emoji	441
22.5.1 Unicode block 26	442
22.6 Lignes horizontales	442
22.7 Links	443
22.8 Code	443
22.9 Tableau	444
22.9.1 Créer un tableau	444
22.9.2 Ajouter une couleur sur les lignes ou les cellules	445
22.9.3 Ajouter une couleur sur la bordure et le texte	445
22.9.4 Pas de bordure ou même couleur que le fond	445
22.9.5 En-tête en gras ou non	446
22.10 Arbre	446
22.11 Caractères spéciaux	448
22.12 Tag HTML	448
22.12.1 Common HTML element	449
22.12.2 Subscript and Superscript element [sub, sup]	450
22.13 OpenIconic	450
22.14 Annexe : Exemples de " liste créole " sur tous les diagrammes	451
22.14.1 Activité	451
22.14.2 Classe	452
22.14.3 Composant, Déploiement, Cas d'utilisation	453
22.14.4 Planification de projet Gantt	454
22.14.5 Object	454
22.14.6 MindMap	455
22.14.7 Réseau (nwdiag)	455
22.14.8 Note	456
22.14.9 Sequence	456
22.14.10 State	456
22.15 Annexe : Exemples de " lignes horizontales créoles " sur tous les diagrammes	456



22.15.1	Activité	456
22.15.2	Classe	457
22.15.3	Composant, déploiement, cas d'utilisation	458
22.15.4	Planification de projet Gantt	459
22.15.5	Objet	459
22.15.6	MindMap	459
22.15.7	Réseau (nwdiag)	460
22.15.8	Note	460
22.15.9	Sequence	461
22.15.10	State	461
22.16	Équivalence de style (entre le créole et le HTML)	461
23	Defining and using sprites	463
23.1	Inline SVG sprite	464
23.2	Changing colors	464
23.3	Encoding Sprite	465
23.4	Importing Sprite	465
23.5	Examples	465
23.6	StdLib	466
23.7	Listing Sprites	466
24	Skinparam command	468
24.1	Usage	468
24.2	Nested	468
24.3	Black and White	468
24.4	Shadowing	469
24.5	Reverse colors	469
24.6	Colors	470
24.7	Font color, name and size	471
24.8	Text Alignment	471
24.9	Examples	472
24.10	List of all skinparam parameters	476
24.10.1	Command Line: -language command	476
24.10.2	Command: help skinparams	476
24.10.3	Command: skinparameters	476
24.10.4	All Skin Parameters on the Ashley's PlantUML Doc	478
25	Preprocesseur	479
25.1	Variable definition [=, ?=]	479
25.2	Boolean expression	480
25.2.1	Boolean representation [0 is false]	480
25.2.2	Boolean operation and operator [&&, , ()]	480
25.2.3	Boolean builtin functions [%false(), %true(), %not(<exp>)]	480
25.3	Conditions [!if, !else, !elseif, !endif]	480
25.4	While loop [!while, !endwhile]	481
25.4.1	While loop (on Activity diagram)	481
25.4.2	While loop (on Mindmap diagram)	482
25.4.3	While loop (on Component/Deployment diagram)	483
25.5	Procedure [!procedure, !endprocedure]	483
25.6	Return function [!function, !endfunction]	484
25.7	Default argument value	485
25.8	Unquoted procedure or function [!unquoted]	486
25.9	Keywords arguments	487
25.10	Including files or URL [!include, !include_many, !include_once]	487
25.11	Including Subpart [!startsub, !endsub, !includesub]	488
25.12	Builtin functions [%]	488
25.13	Logging [!log]	489
25.14	Memory dump [!dump_memory]	490
25.15	Assertion [!assert]	490



25.16	Building custom library [<code>!import</code> , <code>!include</code>]	491
25.17	Search path	491
25.18	Argument concatenation [<code>###</code>]	491
25.19	Dynamic invocation [<code>%invoke_procedure()</code> , <code>%call_user_func()</code>]	492
25.20	Evaluation of addition depending of data types [<code>+</code>]	493
25.21	Preprocessing JSON	493
25.22	Including theme [<code>!theme</code>]	493
25.23	Migration notes	494
25.24	<code>%Splitstr</code> builtin function	494
26	Unicode	495
26.1	Examples	495
26.2	Jeu de caractères	497
26.3	Using Unicode Character on PlantUML	497
27	Bibliothèque standard de PlantUML	498
27.0.1	Vue d'ensemble de la bibliothèque standard	498
27.0.2	Contribution de la communauté	498
27.1	Contenu de la bibliothèque standard	498
27.2	ArchiMate [<code>archimate</code>]	500
27.2.1	Liste des sprites possibles	501
27.3	Amazon Labs AWS Library [<code>awslib</code>]	502
27.4	Azure library [<code>azure</code>]	503
27.5	C4 Library [<code>C4</code>]	504
27.6	Cloud Insight [<code>cloudinsight</code>]	504
27.7	Cloudogu [<code>cloudogu</code>]	505
27.8	Elastic library [<code>elastic</code>]	506
27.9	Google Material Icons [<code>material</code>]	508
27.10	Kubernetes [<code>kubernetes</code>]	509
27.11	Logos [<code>logos</code>]	510
27.12	Office [<code>office</code>]	512
27.13	Open Security Architecture (OSA) [<code>osa</code>]	514
27.14	Tupadr3 library [<code>tupadr3</code>]	517
27.15	Bibliothèque AWS	518

